

# Operation Manual

## Sewing Machine

Product Code: 888-F00/F10/H32

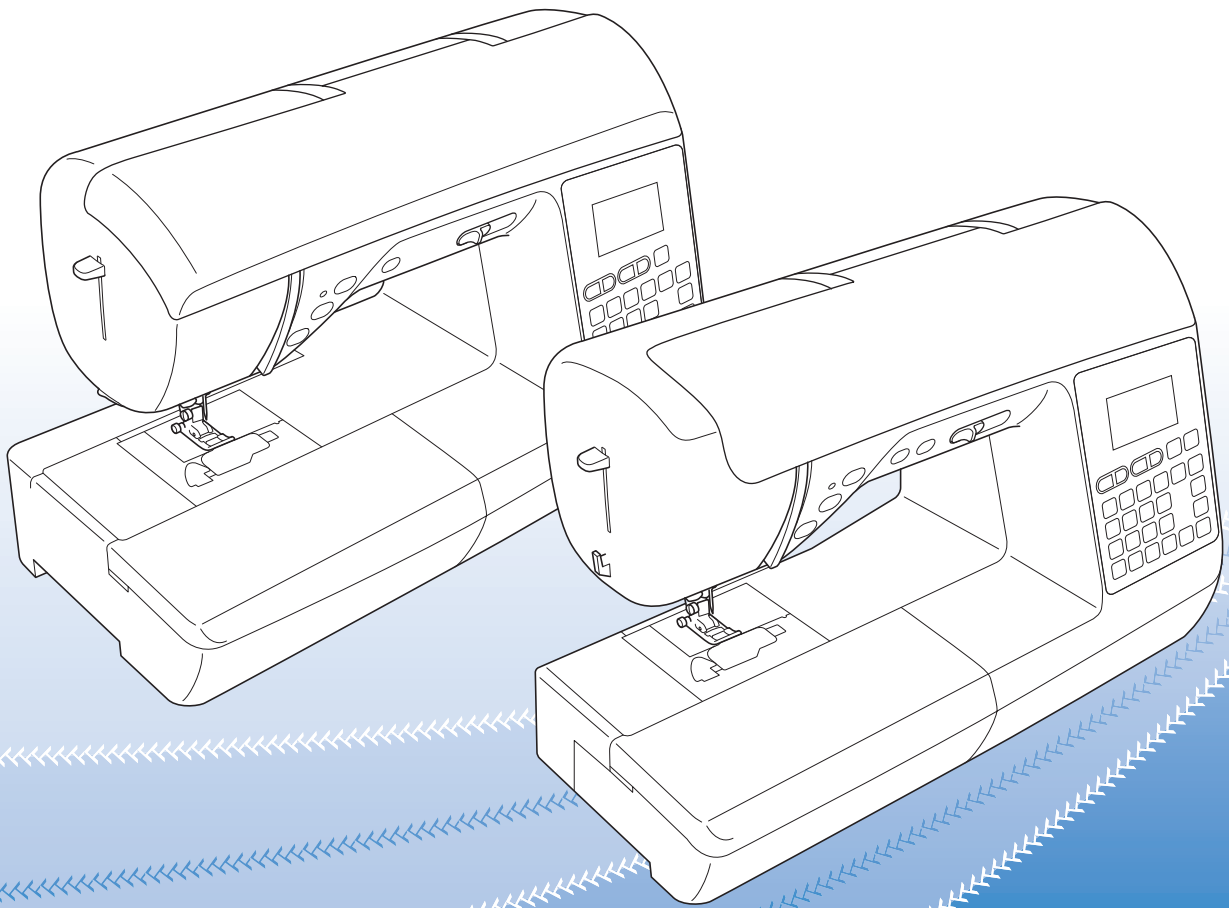

Be sure to read this document before using the machine.  
We recommend that you keep this document nearby for future reference.



## INTRODUCTION

Thank you for purchasing this machine. Before using this machine, carefully read the “IMPORTANT SAFETY INSTRUCTIONS”, and then study this manual for the correct operation of the various functions. In addition, after you have finished reading this manual, store it where it can quickly be accessed for future reference.

## IMPORTANT SAFETY INSTRUCTIONS

Please read these safety instructions before attempting to use the machine.

### **DANGER** - To reduce the risk of electrical shock

- 1** Always unplug the machine from the electrical outlet immediately after using, when cleaning, making any user servicing adjustments mentioned in this manual, or if you are leaving the machine unattended.

### **WARNING** - To reduce the risk of burns, fire, electrical shock, or injury to persons.

- 2** Always unplug the machine from the electrical outlet when making any adjustments mentioned in the instruction manual.

- To unplug the machine, switch the machine to the symbol “O” position to turn it off, then grasp the plug and pull it out of the electrical outlet. Do not pull on the cord.
- Plug the machine directly into the electrical outlet. Do not use an extension cord.
- Always unplug your machine if there is a power failure.

- 3** Electrical Hazards:

- This machine should be connected to an AC power source within the range indicated on the rating label. Do not connect it to a DC power source or converter. If you are not sure what kind of power source you have, contact a qualified electrician.
- This machine is approved for use in the country of purchase only.

- 4** Never operate this machine if it has a damaged cord or plug, if it is not working properly, has been dropped or damaged, or water is spilled on the unit. Return the machine to the nearest authorized Brother dealer for examination, repair, electrical or mechanical adjustment.

- While the machine is stored or in use if you notice anything unusual, such as an odor, heat, discoloration or deformation, stop using the machine immediately and unplug the power cord.
- When transporting the machine, be sure to carry it by its handle. Lifting the machine by any other part may damage the machine or result in the machine falling, which could cause injuries.
- When lifting the machine, be careful not to make any sudden or careless movements, which may cause a personal injury.

## 5 Always keep your work area clear:

- Never operate the machine with any air openings blocked. Keep ventilation openings of the machine and foot control free from the build up of lint, dust, and loose cloth.
- Do not store objects on the foot controller.
- Do not use extension cords. Plug the machine directly into the electrical outlet.
- Never drop or insert foreign objects in any opening.
- Do not operate where aerosol (spray) products are being used or where oxygen is being administered.
- Do not use the machine near a heat source, such as a stove or iron; otherwise, the machine, power cord or garment being sewn may ignite, resulting in fire or an electric shock.
- Do not place this machine on an unstable surface, such as an unsteady or slanted table, otherwise the machine may fall, resulting in injuries.

## 6 Special care is required when sewing:

- Always pay close attention to the needle. Do not use bent or damaged needles.
- Keep fingers away from all moving parts. Special care is required around the machine needle.
- Switch the machine to the symbol "O" position to turn it off when making any adjustments in the needle area.
- Do not use a damaged or incorrect needle plate, as it could cause the needle to break.
- Do not push or pull the fabric when sewing, and follow careful instruction when free motion stitching so that you do not deflect the needle and cause it to break.

## 7 This machine is not a toy:

- Your close attention is necessary when the machine is used by or near children.
- This product contains small parts. Keep the product out of the reach of children to prevent accidental ingestion of small parts.
- The plastic bag that this machine was supplied in should be kept out of the reach of children or disposed of. Never allow children to play with the bag due to the danger of suffocation.
- Do not use outdoors.

## 8 For a longer service life:

- When storing this machine, avoid direct sunlight and high humidity locations. Do not use or store the machine near a space heater, iron, halogen lamp, or other hot objects.
- Do not use cleansers or organic solvents, such as thinner, petroleum ether or alcohol, to clean the machine. Otherwise, the finish may peel off or become scratched.
- Use only neutral soaps or detergents to clean the case. Benzene, thinner, and scouring powders can damage the case and machine, and should never be used.
- Always consult the Operation Manual when replacing or installing any assemblies, the presser feet, needle, or other parts to assure correct installation.

## 9 For repair or adjustment:

- If the light unit is damaged, it must be replaced by an authorized Brother dealer.
- In the event a malfunction occurs or adjustment is required, first follow the troubleshooting table in the back of the Operation Manual to inspect and adjust the machine yourself. If the problem persists, please consult your local authorized Brother dealer.

**Use this machine only for its intended use as described in the manual.**

**Use accessories recommended by the manufacturer as contained in this manual.**

**The contents of this manual and specifications of this product are subject to change without notice.**

**For additional product information, visit our website at [www.brother.com](http://www.brother.com)**

# SAVE THESE INSTRUCTIONS

## This machine is intended for household use.

### FOR USERS IN COUNTRIES EXCEPT EUROPEAN COUNTRIES

This appliance is not intended for use by persons (including children) with reduced physical, sensory or mental capabilities, or lack of experience and knowledge, unless they have been given supervision or instruction concerning use of the appliance by a person responsible for their safety. Children should be supervised to ensure that they do not play with the appliance.

### FOR USERS IN EUROPEAN COUNTRIES

This appliance can be used by children aged from 8 years and above and persons with reduced physical, sensory or mental capabilities or lack of experience and knowledge if they have been given supervision or instruction concerning use of the appliance in a safe way and understand the hazards involved. Children shall not play with the appliance. Cleaning and user maintenance shall not be made by children without supervision.

## FOR USERS IN THE UK, EIRE, MALTA AND CYPRUS ONLY

### IMPORTANT

- In the event of replacing the plug fuse, use a fuse approved by ASTA to BS 1362, i.e. carrying the  mark, rating as marked on plug.
- Always replace the fuse cover. Never use plugs with the fuse cover omitted.
- If the available electrical outlet is not suitable for the plug supplied with this equipment, you should contact your authorized Brother dealer to obtain the correct lead.

## ABOUT THIS MANUAL

This manual was written for several machine models. The illustrations of the machine in this manual may differ from the actual design. In addition, since the specifications differ depending on the model, some functions described in this manual may apply to only some models.

## WHAT YOU CAN DO WITH THIS MACHINE

---

### **B Basic operations**

After purchasing your machine, be sure to read this section first. This section provides details on the initial setup procedures as well as descriptions of this machine's more useful functions.

#### **Chapter 1 GETTING READY**

*Page B-2*

**To learn the operation of the principal parts and the screens**

#### **Chapter 2 STARTING TO SEW**

*Page B-31*

**To learn how to prepare for sewing and basic sewing operations**

### **S Sewing**

This section describes procedures for using the various utility stitches as well as other functions. It provides details on basic machine sewing in addition to the more expressive features of the machine, such as sewing tubular pieces and buttonholes.

#### **Chapter 1 SEWING ATTRACTIVE FINISHES**

*Page S-2*

**Tips for sewing attractive finishes and various fabrics**

#### **Chapter 2 UTILITY STITCHES**

*Page S-6*

**Sew pre-programmed frequently used stitches**

### **D Decorative sewing**

This section provides instructions on sewing character stitches and decorative stitches as well as on adjusting and editing them.

#### **Chapter 1 CHARACTER / DECORATIVE STITCHES**

*Page D-2*

**The variety of stitches widen your creativity**

### **A Appendix**

This section provides important information for operating this machine.

#### **Chapter 1 MAINTENANCE AND TROUBLESHOOTING**

*Page A-2*

**The various maintenance and troubleshooting procedures are described.**

# CONTENTS

INTRODUCTION .....	i
IMPORTANT SAFETY INSTRUCTIONS .....	i
ABOUT THIS MANUAL .....	iv
WHAT YOU CAN DO WITH THIS MACHINE....	iv

## B Basic operations

### Chapter 1 GETTING READY 2

<b>Names of Machine Parts and Their Functions .....</b>	<b>2</b>
Machine .....	2
Needle and presser foot section .....	4
Operation buttons .....	4
Operation panel and operation keys .....	5
Using the flat bed attachment .....	6
Included accessories .....	7
Optional accessories .....	8
<b>Turning the Machine On/Off.....</b>	<b>9</b>
Turning on the machine .....	10
Turning off the machine .....	10
<b>LCD .....</b>	<b>11</b>
Viewing the LCD .....	11
Adjusting input sensitivity for operation keys .....	12
<b>Winding/Installing the Bobbin.....</b>	<b>13</b>
Winding the bobbin .....	13
Installing the bobbin .....	16
<b>Upper Threading .....</b>	<b>19</b>
Threading the upper thread .....	19
Threading the needle .....	21
Threading the needle manually (without using the needle threader) .....	22
Pulling up the bobbin thread.....	23
Using the twin needle .....	23
<b>Fabric/Thread/Needle Combinations .....</b>	<b>26</b>
<b>Replacing the Needle .....</b>	<b>27</b>
Checking the needle .....	27
Replacing the needle .....	27
<b>Replacing the Presser Foot .....</b>	<b>29</b>
Replacing the presser foot .....	29
Removing and attaching the presser foot holder .....	30

### Chapter 2 STARTING TO SEW 31

<b>Sewing.....</b>	<b>31</b>
Stitch selection methods .....	31
Selecting a stitch pattern .....	32
Sewing a stitch .....	33
Sewing reinforcement stitches .....	35
Automatic reinforcement stitching .....	35
Reinforcement priority .....	37
<b>Setting the Stitch .....</b>	<b>38</b>
Setting the stitch width .....	38
Setting the stitch length .....	38
Setting the thread tension .....	39
<b>Useful Functions.....</b>	<b>40</b>
Automatically cutting the thread (Only on models with automatic thread cutting key) .....	40
Adjusting the presser foot pressure .....	41
<b>Stitch Setting Chart .....</b>	<b>42</b>

## S Sewing

### Chapter 1 SEWING ATTRACTIVE FINISHES 2

<b>Sewing Tips.....</b>	<b>2</b>
Trial sewing.....	2
Changing the sewing direction.....	2
Sewing curves .....	2
Sewing cylindrical pieces .....	2
Sewing an even seam allowance .....	3
<b>Sewing Various Fabrics .....</b>	<b>4</b>
Sewing thick fabrics .....	4
Sewing thin fabrics .....	4
Sewing stretch fabrics.....	5
Sewing leathers or vinyl fabrics .....	5
Sewing hook-and-loop fastener tape.....	5

### Chapter 2 UTILITY STITCHES 6

<b>Basic Stitching.....</b>	<b>6</b>
Basting .....	6
Basic stitching .....	6
<b>Blind Hem Stitching .....</b>	<b>8</b>
<b>Overcasting Stitches .....</b>	<b>11</b>
Sewing overcasting stitches using overcasting foot "G" .....	11
Sewing overcasting stitches using zigzag foot "J" .....	12
Sewing overcasting stitches using the side cutter (sold separately with some models) .....	12
<b>Buttonhole Stitching/Button Sewing .....</b>	<b>14</b>
Buttonhole sewing.....	14
Button sewing .....	17
<b>Zipper Insertion .....</b>	<b>20</b>
Inserting a centered zipper .....	20
Inserting a side zipper .....	21
<b>Zipper/piping Insertion .....</b>	<b>24</b>
Inserting a centered zipper .....	24
Inserting a piping.....	25
<b>Sewing Stretch Fabrics and Elastic Tape.....</b>	<b>26</b>
Stretch stitching.....	26
Elastic attaching .....	26
<b>Appliqué, Patchwork and Quilt Stitching.....</b>	<b>27</b>
Appliqué stitching .....	27
Patchwork (crazy quilt) stitching.....	28
Piecing .....	28
Quilting.....	30
Free motion quilting .....	31
Satin stitching using the sewing speed controller .....	32
<b>Reinforcement Stitching.....</b>	<b>33</b>
Triple stretch stitching .....	33
Bar tack stitching.....	33
Darning.....	34
<b>Eyelet Stitching .....</b>	<b>36</b>
<b>Decorative Stitching .....</b>	<b>37</b>
Fagoting .....	37
Scallop stitching .....	38
Smocking .....	38
Shell tuck stitching .....	39
Joining.....	39
Heirloom stitching.....	40

## D Decorative sewing

### Chapter 1 CHARACTER / DECORATIVE STITCHES 2

**Sewing the Various Built-in Decorative Patterns.... 2**

- Selecting stitch patterns ..... 2
- Deleting a pattern..... 3
- Sewing attractive finishes ..... 3
- Basic sewing ..... 4
- Combining patterns ..... 5
- Checking the selected pattern..... 6
- Repeating combined patterns ..... 6
- Saving a pattern..... 6
- Retrieving a pattern ..... 7
- Realigning the pattern ..... 7

## A Appendix

### Chapter 1 MAINTENANCE AND TROUBLESHOOTING 2

**Care and Maintenance..... 2**

- Restrictions on oiling ..... 2
- Precautions on storing the machine ..... 2
- Cleaning the LCD screen ..... 2
- Cleaning the machine surface ..... 2
- Cleaning the race ..... 2

**Troubleshooting..... 5**

- Frequent troubleshooting topics ..... 5
- Upper thread tightened up ..... 5
- Tangled thread on wrong side of fabric ..... 6
- Incorrect thread tension ..... 7
- Fabric is caught in the machine and cannot be removed ..... 8
- If the thread becomes tangled under the bobbin winder seat ..... 11
- Error message "E06" appears in the LCD ..... 13
- List of symptoms..... 15
- Error messages..... 21
- Operation beep ..... 22

**Index ..... 23**



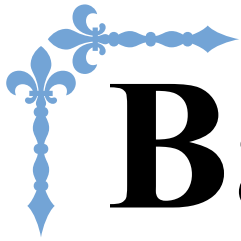

# Basic operations

This section provides details on the initial setup procedures as well as descriptions of this machine's more useful functions.

Page number starts with "B" in this section.

**Chapter1 GETTING READY .....B-2**

---

**Chapter2 STARTING TO SEW .....B-31**

---

# Chapter 1 GETTING READY

## Names of Machine Parts and Their Functions

The names of the various parts of the machine and their functions are described below. Before using the machine, carefully read these descriptions to learn the names of the machine parts and their locations.

### Machine

#### ■ Front view

The appearance of the machine differs depending on the model.

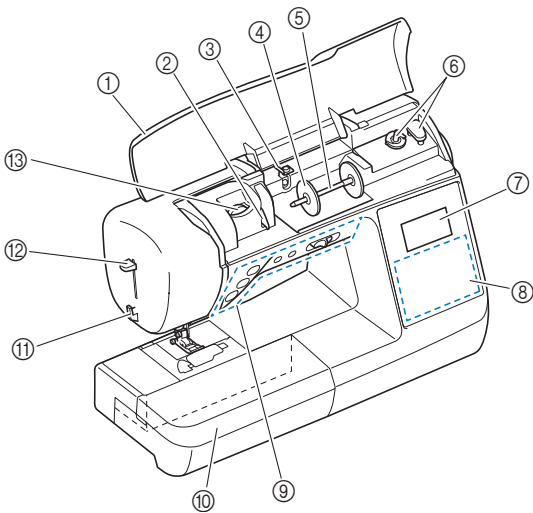
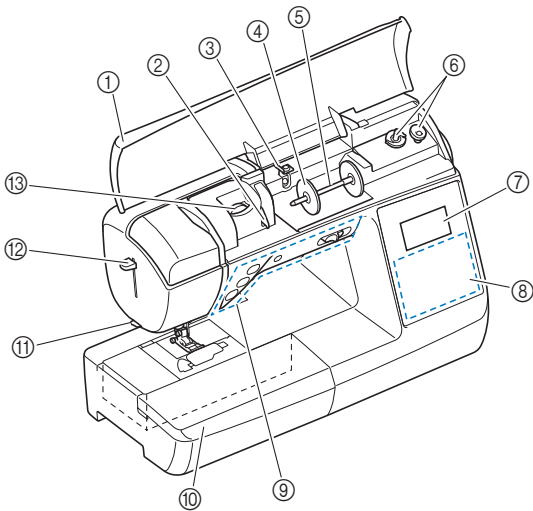

- ① **Top cover**  
Open the top cover to place the spool of thread on the spool pin.
- ② **Thread guide plate**  
Pass the thread around the thread guide plate when threading the upper thread.
- ③ **Bobbin winding thread guide and pretension disk**  
Pass the thread under this thread guide and around the pretension disk when winding the bobbin thread.
- ④ **Spool cap**  
Use the spool cap to hold the spool of thread in place.
- ⑤ **Spool pin**  
Place a spool of thread on the spool pin.
- ⑥ **Bobbin winder**  
Use the bobbin winder when winding the bobbin.
- ⑦ **LCD (liquid crystal display)**  
Settings for the selected stitch and error messages appear in the LCD. (page B-11)
- ⑧ **Operation panel**  
From the operation panel, stitch settings can be selected and edited, and operations for using the machine can be selected. (page B-5)
- ⑨ **Operation buttons and sewing speed controller**  
Use these buttons and the slide to operate the machine. (page B-4)
- ⑩ **Flat bed attachment**  
Insert the presser foot accessory tray into the accessory compartment of the flat bed attachment. Remove the flat bed attachment when sewing cylindrical pieces such as sleeve cuffs.
- ⑪ **Thread cutter**  
Pass the threads through the thread cutter to cut them.
- ⑫ **Needle threader lever**  
Use the needle threader lever to thread the needle.
- ⑬ **Thread tension dial**  
Use the dial to adjust the upper thread tension. (page B-39)

## ■ Right-side/rear view

The appearance of the machine differs depending on the model.

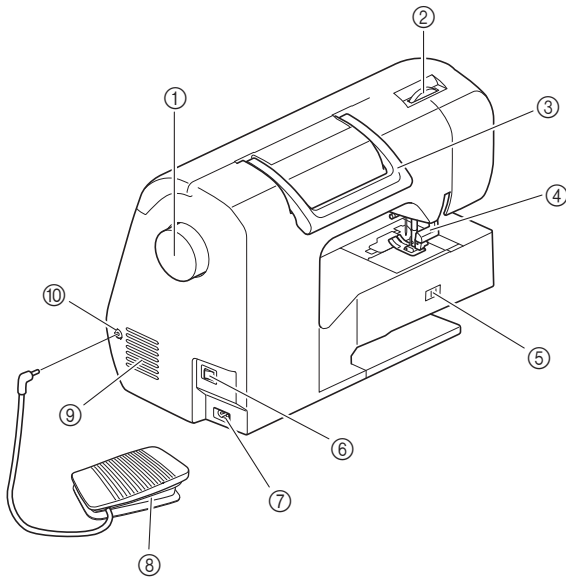
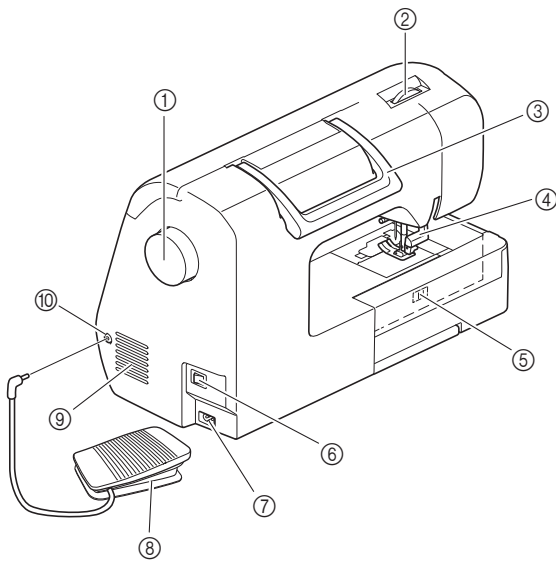

- ① **Handwheel**  
Turn the handwheel toward you (counterclockwise) to raise and lower the needle to sew one stitch.
- ② **Presser foot pressure dial**  
Adjust the amount of pressure that the presser foot applies to the fabric.
- ③ **Handle**  
Carry the machine by its handle when transporting.
- ④ **Presser foot lever**  
Raise and lower the presser foot lever to raise and lower the presser foot.
- ⑤ **Feed dog position switch**  
Use the feed dog position switch to raise and lower the feed dogs. (page S-31)
- ⑥ **Main power switch**  
Use the main power switch to turn the machine on and off.
- ⑦ **Power supply jack**  
Insert the plug on the power supply cord into the power supply jack.
- ⑧ **Foot controller**  
Depress the foot controller to control the speed of the machine. (page B-34)
- ⑨ **Air vent**  
The air vent allows the air surrounding the motor to circulate. Do not cover the air vent while the machine is being used.
- ⑩ **Foot controller jack**  
Insert the plug on the end of the foot controller cable into the foot controller jack.



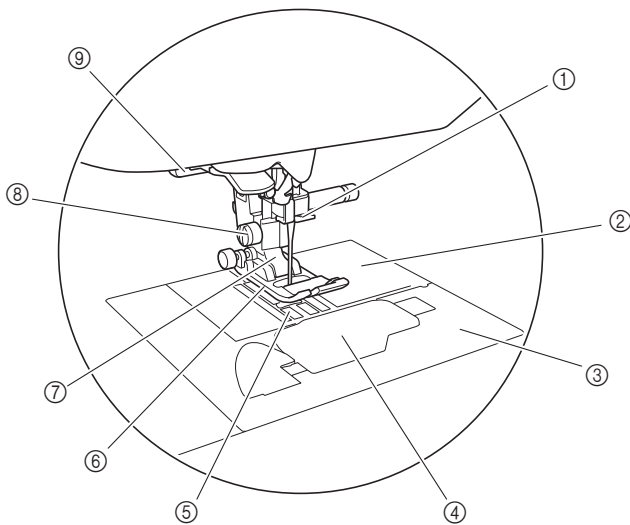

## Needle and presser foot section



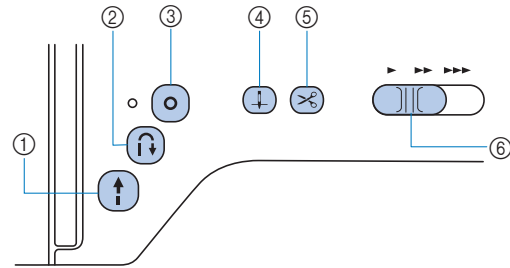

- ① **Needle bar thread guide**  
Pass the upper thread through the needle bar thread guide.
- ② **Needle plate**  
The needle plate is marked with guides for sewing straight seams.
- ③ **Needle plate cover**  
Remove the needle plate cover to clean the bobbin case and race.
- ④ **Bobbin cover/bobbin case**  
Remove the bobbin cover, and then insert the bobbin into the bobbin case.
- ⑤ **Feed dogs**  
The feed dogs feed the fabric in the sewing direction.
- ⑥ **Presser foot**  
The presser foot applies pressure consistently on the fabric as the sewing takes place. Attach the appropriate presser foot for the selected stitch.
- ⑦ **Presser foot holder**  
The presser foot is attached onto the presser foot holder.
- ⑧ **Presser foot holder screw**  
Use the presser foot holder screw to hold the presser foot in place. (page B-30)
- ⑨ **Buttonhole lever**  
Lower the buttonhole lever when sewing buttonholes and bar tacks or when darning.

## Operation buttons



- ① **“Start/Stop” button**   
Press the “Start/Stop” button to start or stop sewing. The machine stitches at a slow speed at the beginning of sewing while the button is pressed. When sewing is stopped, the needle is lowered in the fabric. For details, refer to “STARTING TO SEW” on page B-31.  
The button changes color according to the machine’s operation mode.  
  
Green: The machine is ready to sew or is sewing.  
Red: The machine can not sew.  
Orange: The machine is winding the bobbin thread, or the bobbin winder shaft is moved to the right side.
- ② **Reverse stitch button**   
For straight, zigzag, and elastic zigzag stitch patterns that use reverse stitches, the machine will sew reverse stitches at low speed only while holding down the Reverse stitch button. The stitches are sewn in the opposite position.  
For other stitches, use this button to sew reinforcement stitches at the beginning and end of sewing. Press and hold this button, and the machine sews 3 stitches in the same spot and stops automatically. (page B-35)
- ③ **Reinforcement stitch button**   
Use this button to sew a single stitch repeatedly and tie-off.  
For character/decorative stitches, press this button to end with a full stitch instead of at a mid-point. The LED light beside this button lights up while the machine is sewing a full motif, and automatically turns off when the sewing is stopped. (page B-35)
- ④ **Needle position button**   
Press the needle position button to raise or lower the needle. Pressing the button twice sews one stitch.
- ⑤ **Thread cutter button**   
**(Equipped on some models.)**  
Press the thread cutter button after sewing is stopped to cut both the upper and the bobbin threads. For details, refer to step 10 under “Sewing a stitch” on page B-34.
- ⑥ **Sewing speed controller**  
Slide the sewing speed controller to adjust the sewing speed.

## CAUTION

- (Only on models with  (Thread cutter button))  
Do not press  (Thread cutter button) after the threads have already been cut, otherwise the needle may break, the threads may become tangled or damage to the machine may occur.

## Operation panel and operation keys

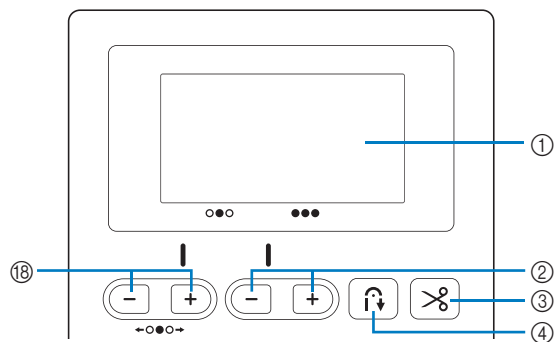
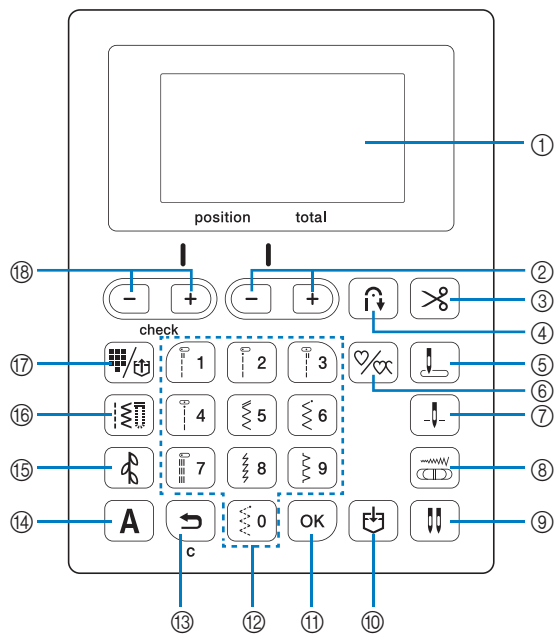

- ① **LCD (liquid crystal display)**  
Settings for the selected stitch and error messages for incorrect operations appear in the LCD.  
For details, refer to "LCD" on page B-11
- ② **Stitch length keys**   
Press to adjust the stitch length in the LCD.
- ③ **Automatic thread cutting key**   
**(Equipped on some models.)**  
Press to select the automatic thread cutting function.
- ④ **Automatic reverse/reinforcement key**   
Press to use the automatic reverse/reinforcement stitching function.
- ⑤ **Initial needle position key**   
Press to select either "1 Straight stitch (Left)" or "3 Straight stitch (Middle)" as the utility stitch that is automatically selected when the machine is turned on.
- ⑥ **Single/repeat sewing key**   
Press to choose single pattern or continuous patterns.
- ⑦ **Needle position key**   
Press to select the needle stop position (the needle position for when the machine is not being operated) to be up or down.
- ⑧ **Width control key**   
Press to allow the stitch width to be adjusted using the sewing speed controller. For details, refer to "Satin stitching using the sewing speed controller" in the "Sewing" section.
- ⑨ **Twin needle key**   
Press to use the twin needle. For details, refer to "Using the twin needle" on page B-23.

- ⑩ **Memory key**   
Press to save stitch pattern combinations to machine memory.  
For details, refer to "Saving a pattern" in the "Decorative sewing" section.
- ⑪ **OK key**   
Press to apply the selection, perform the operation or add a stitch pattern.
- ⑫ **Numeric keys**  
Use these keys to quickly select one of the ten most often used stitches. When selecting other stitches, use these keys to enter the number of the desired stitch.
- ⑬ **Back key**   
Press this key to cancel the operation and return to the previous screen.  
In addition, pressing this key removes the last pattern added when combining characters or decorative stitches.
- ⑭ **Character stitch key** **A**   
Press to select a character stitch.
- ⑮ **Decorative stitch key**   
Press to select a decorative stitch.
- ⑯ **Utility stitch key**   
Press to select a utility stitch.
- ⑰ **Preset utility stitch/saved pattern key**   
Press to select the utility stitch assigned to a numeric key or to retrieve a pattern that has been saved.
- ⑱ **Stitch width keys/Pattern check keys**   
Press to adjust the stitch width or to check stitch pattern combinations in the LCD.



### Note

- The operation keys of this machine are capacitive touch sensors. Operate the keys by directly touching them with your finger.  
The response of the keys varies according to the user.  
The pressure exerted on the keys does not affect the response of the keys.
- Since the operation keys react differently depending on the user, adjust the setting for the input sensitivity. (page B-12)
- When using an electrostatic touch pen, make sure that its point is 8 mm or more. Do not use a touch pen with a thin point or a unique shape.

## Using the flat bed attachment

Pull the top of the flat bed attachment to open the accessory compartments.

The shape of the flat bed attachment differs depending on the machine model.

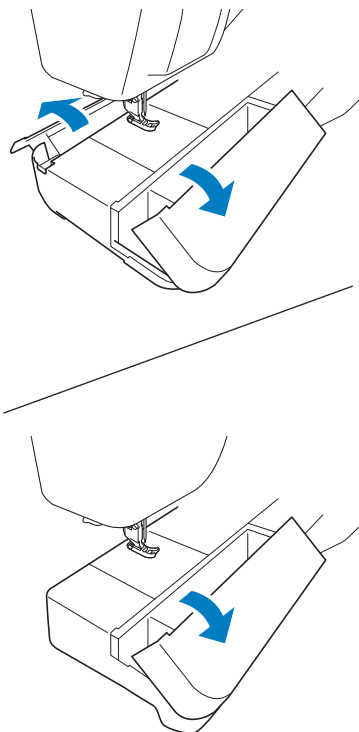



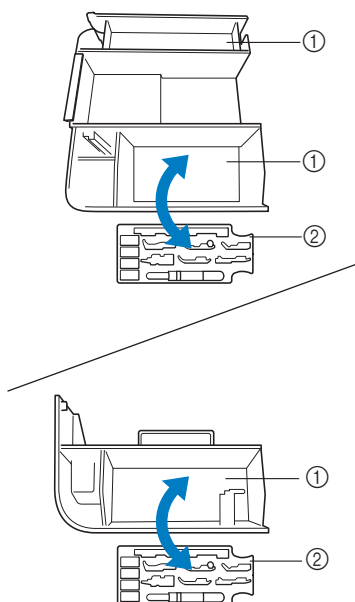







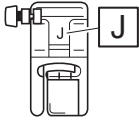
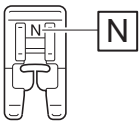
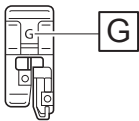
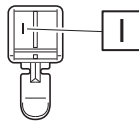
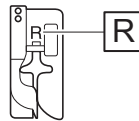
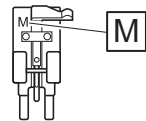
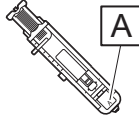

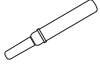

A presser foot accessory tray is stored in the accessory compartment of the flat bed attachment.

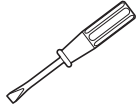
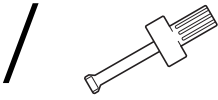

- ① Storage space of the flat bed attachment
- ② Presser foot accessory tray

## Included accessories

Included accessories may differ from the table below depending on your model. For more details on included accessories and their part codes of your machine, refer to the Quick Reference Guide.

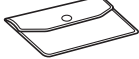
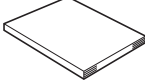
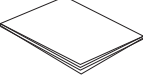
1.  Zigzag foot "J" (on machine)	2.  Monogramming foot "N"	3.  Overcasting foot "G"	4.  Zipper foot "I"	5.  Blind stitch foot "R"	6.  Button fitting foot "M"
7.  Buttonhole foot "A"	8.  Needle set *1	9.  Twin needle *2	10.  Bobbin (4) (One is on machine.)	11.  Seam ripper	12.  Cleaning brush
13.  Eyelet punch	14.  Screwdriver *3	15.  Disc-shaped screwdriver	16.  Horizontal spool pin	17.  Spool cap (large)	18.  Spool cap (medium) (2) (One is on machine.)
19.  Spool cap (small)	20.  Thread spool insert (mini king thread spool)	21.  Spool net	22.  Bobbin case (on machine)	23.  Foot controller	24.  Accessory bag
25.  Operation Manual	26.  Quick Reference Guide	<p>*1 75/11 2 needles, 90/14 2 needles, 90/14 2 needles: Ball point needle (gold colored)</p> <p>*2 2/11 needle</p> <p>*3 Either of the two is included with this machine.</p>			



### Note

- (For U.S.A. only) Foot controller: Model T  
This foot controller can be used on the machine with product code 888-F00/F10. The product code is mentioned on the machine rating plate.

## Optional accessories

The following are available as optional accessories to be purchased separately. Optional accessories differ depending on your model. For more optional accessories and their part codes, refer to the Quick Reference Guide.

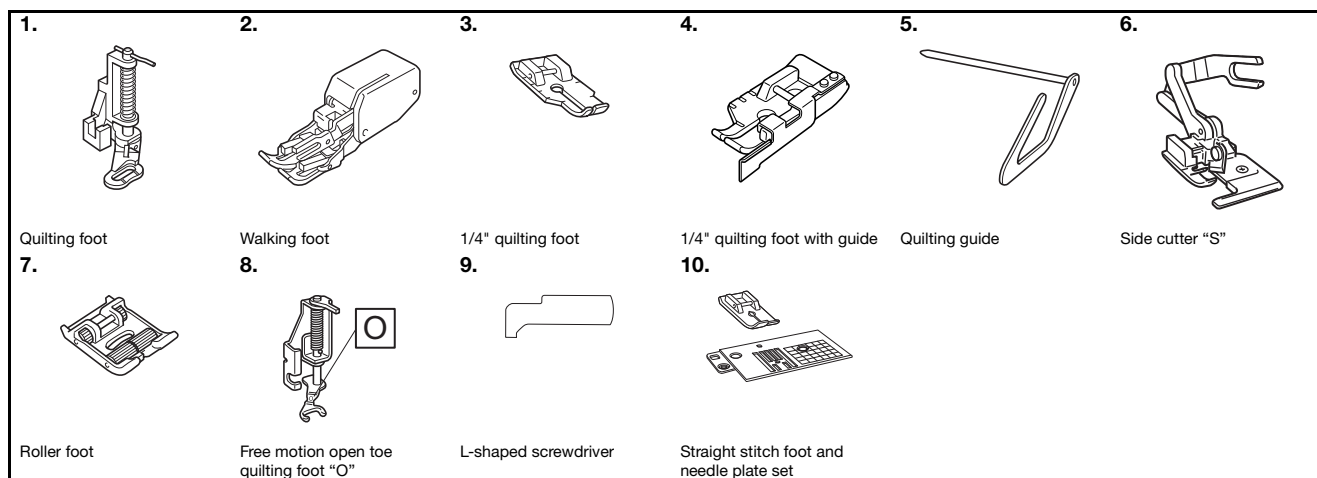

### Memo

- To obtain optional accessories or parts, contact your authorized Brother dealer.
- All specifications are correct at the time of printing. Please be aware that some specifications may change without notice.
- A variety of feet are available to enable different types of stitching and finishes. Visit your nearest authorized Brother dealer for a complete listing of optional accessories available for your machine.
- Always use accessories recommended for this machine.



## Turning the Machine On/Off

### WARNING

- Use only regular household electricity for the power source. Using other power sources may result in fire, electric shock, or damage to the machine.
- Make sure that the plugs on the power cord are firmly inserted into the electrical outlet and the power cord receptacle on the machine. Otherwise, a fire or electric shock may result.
- Do not insert the plug on the power cord into an electrical outlet that is in poor condition.
- Turn the main power to OFF and remove the plug in the following circumstances:
  - When you are away from the machine
  - After using the machine
  - When the power fails during use
  - When the machine does not operate correctly due to a bad connection or a disconnection
  - During electrical storms

### CAUTION

- Use only the power cord included with this machine.
- Do not use extension cords or multi-plug adapters with any other appliances plugged into them. Fire or electric shock may result.
- Do not touch the plug with wet hands. Electric shock may result.
- When unplugging the machine, always turn the main power to OFF first. Always grasp the plug to remove it from the electrical outlet. Pulling on the cord may damage the cord, or lead to fire or electric shock.
- Do not allow the power cord to be cut, damaged, modified, forcefully bent, pulled, twisted, or bundled. Do not place heavy objects on the cord. Do not subject the cord to heat. These things may damage the cord, or cause fire or electric shock. If the cord or plug is damaged, take the machine to your authorized Brother dealer for repairs before continuing use.
- Unplug the power cord if the machine is not to be used for a long period of time. Otherwise, a fire may result.
- When leaving the machine unattended, either the main switch of the machine should be turned to OFF or the plug must be removed from the electrical outlet.
- When servicing the machine or when removing covers, the machine must be unplugged.
- (For U.S.A. only)
  - This appliance has a polarized plug (one blade wider than the other). To reduce the risk of electrical shock, this plug is intended to fit in a polarized electrical outlet only one way.
  - If the plug does not fit fully in the electrical outlet, reverse the plug. If it still does not fit, contact a qualified electrician to install the proper electrical outlet. Do not modify the plug in any way.

## Turning on the machine

- 1 Make sure that the machine is turned off (the main power switch is set to "○"), and then plug the power cord into the power supply jack on the right side of the machine.
- 2 Insert the plug of the power cord into a household electrical outlet.

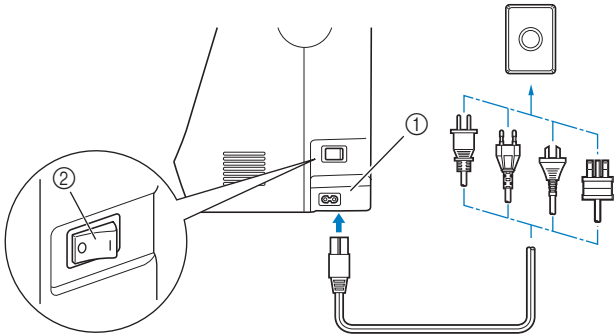

- 1 Power supply jack
- 2 Main power switch

- 3 Press the right side of the main power switch on the right side of the machine to turn the machine on (set it to "I").

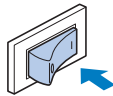

→ The light, LCD and the "Start/Stop" button light up when the machine is turned on.

### Memo

- When the machine is turned on, the needle and the feed dogs will make a sound when they move; this is not a malfunction.
- If the machine is turned off in the middle of sewing in the "Sewing" function, the operation will not resume after turning the power on again.

## Turning off the machine

When you are finished using the machine, turn it off. In addition, before transporting the machine to another location, be sure to turn it off.

- 1 Make sure that the machine is not sewing.
- 2 Press the main power switch on the right side of the machine in the direction of the "○" symbol to turn the machine off.

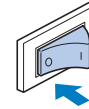

## LCD

## Viewing the LCD

When the power is turned on, the LCD comes on, and the following screen is displayed.

The screen is changed using the keys below the LCD.

### Utility stitch screen

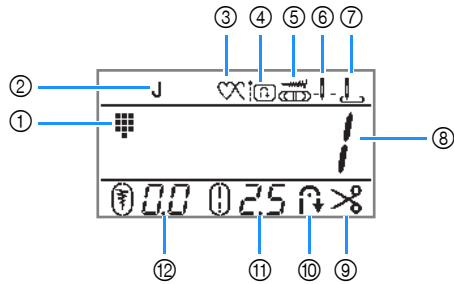

### Character/Decorative stitch screen (refer to the “Decorative sewing” section)

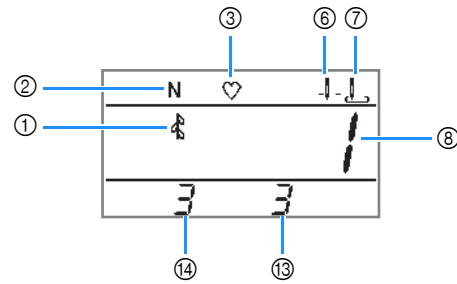



No.	Display	Item Name	Explanation	Page
①		Stitch category	Shows the category of the currently selected stitch pattern. : Preset utility stitch : Utility stitch : Decorative stitch <b>A 1</b> : Character stitch (Gothic font) <b>A 2</b> : Character stitch (Handwriting font) <b>A 3</b> : Character stitch (Outline) <b>A 4</b> : Character stitch (Japanese font)	B-31
②		Presser foot	Shows presser foot to be used.	B-29
③		Single/repeat sewing	Shows single or continuous pattern sewing mode setting. : Single sewing mode : Repeat sewing mode	D-6
④		Reinforcement priority	Shows that reinforcement priority has been set to “ON”.	B-37
⑤		Width control	Shows that the stitch width can be adjusted using the sewing speed controller.	S-32
⑥		Needle position setting	Shows single or twin needle mode setting, and the needle stop position. : Single needle/down position : Single needle/up position : Twin needle/down position : Twin needle/up position	B-5
⑦		Initial needle position	Shows either “1 Straight stitch (Left)” or “3 Straight stitch (Middle)” as the utility stitch that is automatically selected when the machine is turned on. : Straight stitch (Left) : Straight stitch (Middle)	B-5
⑧	-	Stitch number	Shows the number of the currently selected stitch pattern.	B-42
⑨		Automatic thread cutting (Equipped on some models)	Shows automatic cutting for both the upper and the bobbin threads after sewing.	B-40
⑩		Automatic reverse/reinforcement stitching	Shows automatic reverse or reinforcement stitching after a stitch pattern is sewn.	B-35
⑪		Stitch length	Shows the stitch length of the currently selected stitch pattern.	B-38
⑫		Stitch width	Shows the stitch width of the currently selected stitch pattern.	B-38
⑬	-	Total number	Shows the total number of characters that are being combined.	D-5
⑭	-	Position number	Shows the position of the selected stitch number.	D-5

## Adjusting input sensitivity for operation keys

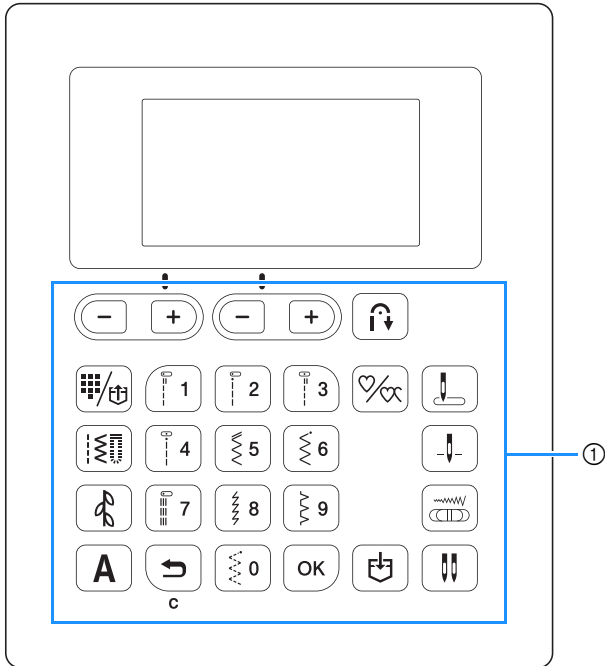
You can adjust the sensitivity of the operation keys to five levels. Display the settings screen to set desired level.



① Operation keys

- 1 Turn off the machine.
- 2 While pressing  (Reinforcement stitch button) on the operation panel, turn on the sewing machine.
- 3 Press the “-” or “+” key to select “ 3”.

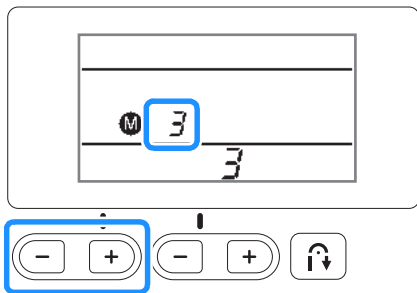

- 4 Adjust the input sensitivity by pressing the “-” or “+” key.
  - The lower the setting, the less sensitive the keys will be; the higher the setting, the more sensitive the keys will be. The default setting is “3”.

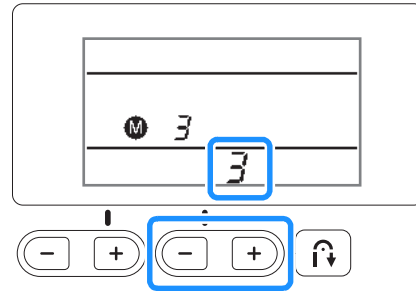

 **Note**

- We recommend selecting the highest setting if an electrostatic touch pen is being used.

- 5 Press any of the operation keys, other than the “-” or “+” key to check the setting. When the key responds, “ON” blinks.
- 6 Turn off the machine, then turn it on again.

 **Note**

- Before turning off the machine, press any of the keys, other than “-” or “+” key. Otherwise the machine may not save the setting.

### ■ If the machine does not respond when an operation key is pressed

Turn machine off, then hold down  (Needle position button) and turn on the machine to reset the settings. Turn off the machine, and then adjust the settings again.

## Winding/Installing the Bobbin

### ⚠ CAUTION

- The included bobbin was designed specifically for this machine. Use the included bobbin or bobbins of the same type (part code: SA156, SFB: XA5539-151). SA156 is Class15 type bobbin.

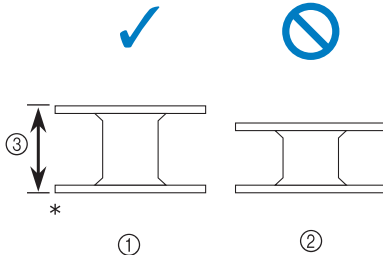

- \* Made of plastic
- ① This model
  - ② Other models
  - ③ 11.5 mm (approx. 7/16 inch)

### 📖 Memo

- When the foot controller is connected, bobbin winding can be started and stopped with the foot controller.

## Winding the bobbin

This section describes how to wind thread onto a bobbin.

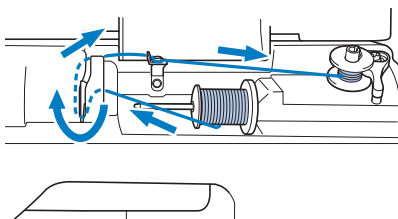

### 📖 Memo

- The shape of the bobbin winder guide post will differ depending on your model; however, this should not affect the operating procedure. This manual describes the procedure for models with a key-shaped bobbin winder guide post.

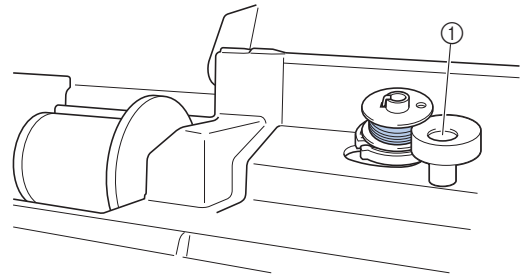

① Bobbin winder guide post (oval)

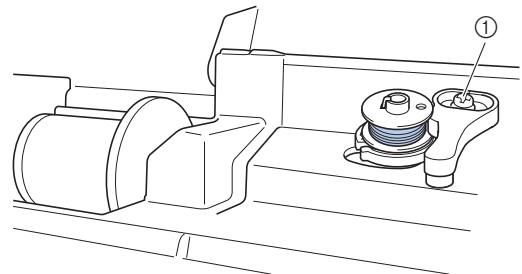

① Bobbin winder guide post (key)

- Open the top cover.
- Place the bobbin on the bobbin winder shaft so that the spring on the shaft fits into the notch in the bobbin. Press down on the bobbin until it snaps into place.

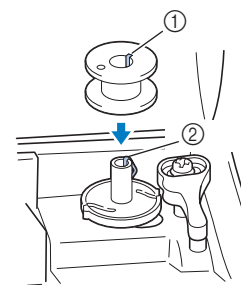

- ① Notch
- ② Bobbin winder shaft spring

- Slide the bobbin winder in the direction of the arrow until it snaps into place.

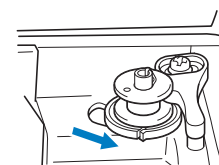

- 4** Remove the spool cap that is inserted onto the spool pin.

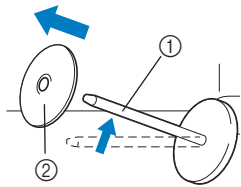

- ① Spool pin
- ② Spool cap

- 5** Place the spool of thread for the bobbin onto the spool pin.

Slide the spool onto the pin so that the spool is horizontal and the thread unwinds to the front at the bottom.

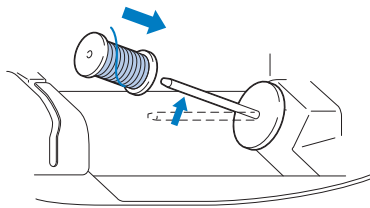

- If the spool is not positioned so that the thread unwinds correctly, the thread may become tangled around the spool pin.

- 6** Slide the spool cap onto the spool pin.

Slide the spool cap as far as possible to the right, as shown, with the rounded side on the left.

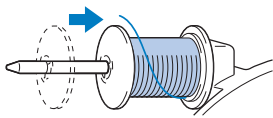

## ⚠ CAUTION

- If the spool or the spool cap is not installed correctly, the thread may become tangled around the spool pin, and the machine may be damaged.
- Three spool cap sizes are available, allowing you to choose a spool cap that best fits the size of spool being used. If the spool cap is too small for the spool being used, the thread may catch on the slit in the spool or the machine may be damaged. When using mini king thread spool, use the thread spool insert (mini king thread spool).  
For details on thread spool insert (mini king thread spool), refer to “Memo” on page B-14.

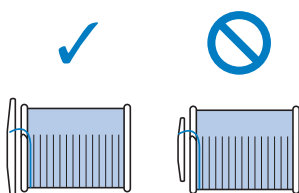

## 📖 Memo

- When using the spool as shown below, use the small spool cap, and leave a small space between the cap and the spool.

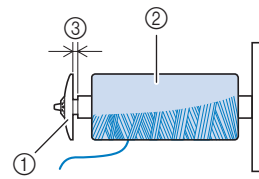

- ① Spool cap (small)
- ② Spool (cross-wound thread)
- ③ Space

- When using thread that winds off quickly, such as transparent nylon thread or metallic thread, place the spool net over the spool before placing the spool of thread onto the spool pin. If the spool net is too long, fold it to fit the size of the spool.

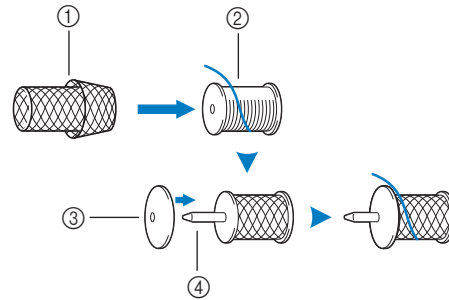

- ① Spool net
- ② Spool
- ③ Spool cap
- ④ Spool pin

- If a spool of thread whose core is 12 mm (1/2 inch) in diameter and 75 mm (3 inches) high is inserted onto the spool pin, use the thread spool insert (mini king thread spool).

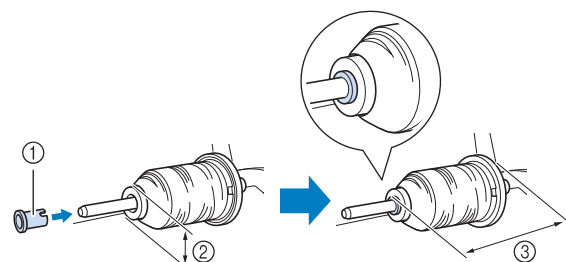

- ① Thread spool insert (mini king thread spool)
- ② 12 mm (1/2 inch)
- ③ 75 mm (3 inches)

- 7** While holding the thread near the spool with your right hand, as shown, pull the thread with your left hand, and then pass the thread behind the thread guide cover and to the front.

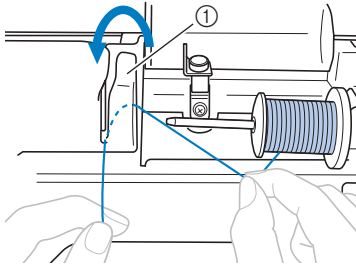

① Thread guide cover

- 8** Pass the thread under the thread guide plate, and then pull it to the right.

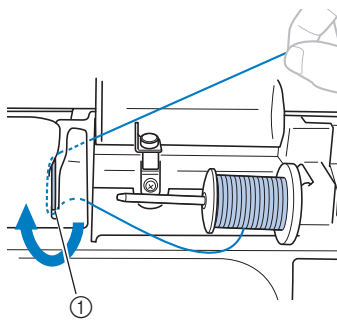

① Thread guide plate

- 9** Pass the thread under the hook on the thread guide, and then wind it counterclockwise under the pretension disk.

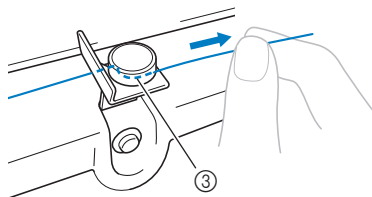
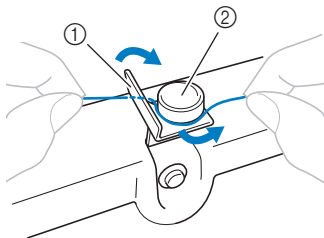

- ① Thread guide  
② Pretension disk  
③ Pull it in as far as possible

**Note**

- Make sure that the thread passes under the pretension disk.

- 10** While holding the thread with your left hand, wind the thread that was pulled out clockwise around the bobbin five or six times with your right hand.

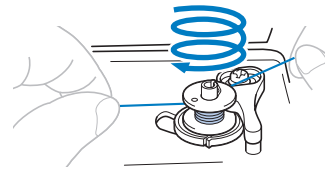
**Note**

- Make sure that the thread between the spool and the bobbin is pulled tight.
- Be sure to wind the thread clockwise around the bobbin, otherwise the thread will become wrapped around the bobbin winder shaft.

- 11** Pass the end of the thread through the guide slit in the bobbin winder seat, and then pull the thread to the right to cut it.

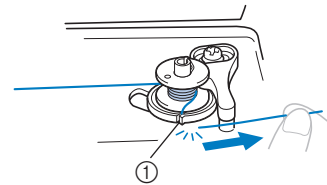

① Guide slit in bobbin winder seat (with built-in cutter)

**CAUTION**

- Be sure to cut the thread as described. If the bobbin is wound without cutting the thread using the cutter built into the slit in the bobbin winder seat, the thread may become tangled in the bobbin or the needle may bend or break when the bobbin thread starts to run out.

- 12** Slide the sewing speed controller to the right.

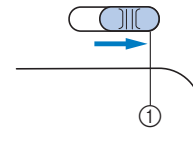

① Speed controller

**Note**

- Bobbin winding speeds may vary depending on type of thread being wound on bobbin.

- 13 Turn on the machine.
- 14 Press the “Start/Stop” button once to start winding the bobbin.  
When the foot controller is plugged in, press down on the foot controller.

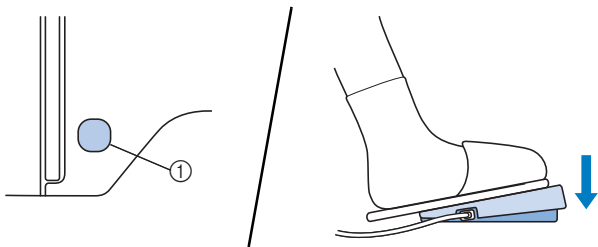

① “Start/Stop” button

**Note**

- When winding transparent nylon thread on the bobbin, stop bobbin winding when the bobbin is 1/2 to 2/3 full.  
If the bobbin is fully wound with transparent nylon thread, the pressure may create fractures to the plastic bobbin. This will lead to irregular stitches or possible breakage to bobbin.

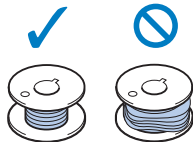

- 15 When the bobbin winding becomes slow, press the “Start/Stop” button once to stop the machine.  
When the foot controller is plugged in, remove your foot from the foot controller.

**CAUTION**

- When the bobbin winding becomes slow, stop the machine, otherwise the machine may be damaged.

- 16 Use scissors to cut the end of the thread wound around the bobbin.

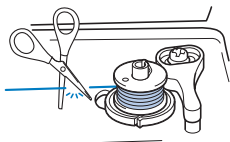

- 17 Slide the bobbin winder shaft to the left, and then remove the bobbin from the shaft.

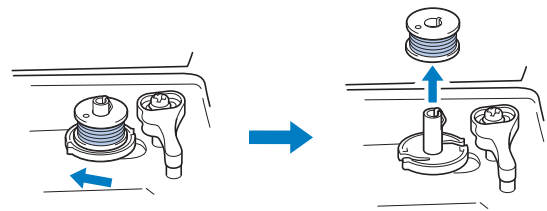

**Memo**

- If the bobbin winder shaft is set to the right side, the needle will not move. (Sewing is impossible.)

- 18 Slide the sewing speed controller back to desired sewing speed position.

- 19 Remove the spool for the bobbin thread from the spool pin.

**Memo**

- When the machine is started or the handwheel is turned after winding the bobbin, the machine will make a clicking sound; this is not a malfunction.

**Installing the bobbin**

Install the bobbin wound with thread.  
You can begin sewing immediately without pulling up the bobbin thread by simply inserting the bobbin in the bobbin case and guiding the thread through the slit in the needle plate cover.

**Memo**

- For details on sewing after pulling up the bobbin thread, for example, when making gathers or with free motion quilting, refer to “Pulling up the bobbin thread” on page B-23.

**CAUTION**

- Use a bobbin that has been correctly wound with thread, otherwise the needle may break or the thread tension will be incorrect.

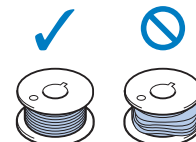

- Before inserting or changing the bobbin, be sure to turn off the machine, otherwise injuries may occur if the “Start/Stop” button or any other button is pressed and the machine starts operating.



- 1 Press  (Needle position button) once or twice to raise the needle.
- 2 Turn off the machine.
- 3 Raise the presser foot lever.
- 4 Slide the bobbin cover latch to the right.

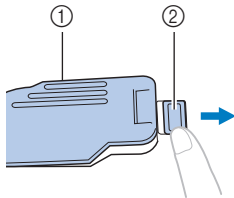

- ① Bobbin cover  
② Latch

- 5 Remove the bobbin cover.
- 6 Hold the bobbin with your right hand with the thread unwinding to the left, and hold the end of the thread with your left hand. Then, with your right hand, place the bobbin in the bobbin case.

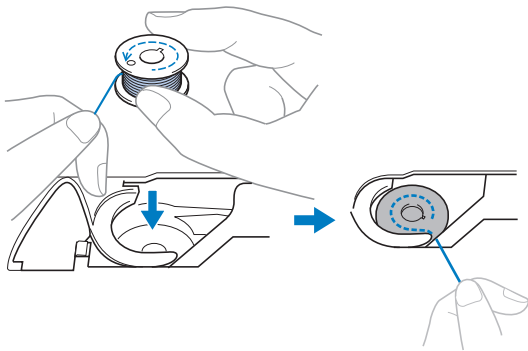

- 7 Lightly hold down the bobbin with your right hand (①), and then guide the end of the thread around the tab of the needle plate cover with your left hand (②).

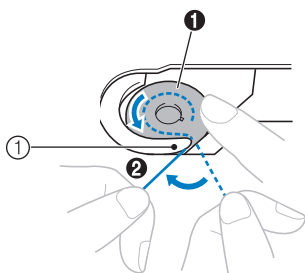

- ① Tab

## ⚠ CAUTION

- Be sure to hold down the bobbin with your finger and unwind the bobbin thread correctly, otherwise the thread may break or the thread tension will be incorrect.

### Memo

- The order that the bobbin thread should be passed through the bobbin case is indicated by marks around the bobbin case. Be sure to thread the machine as indicated.

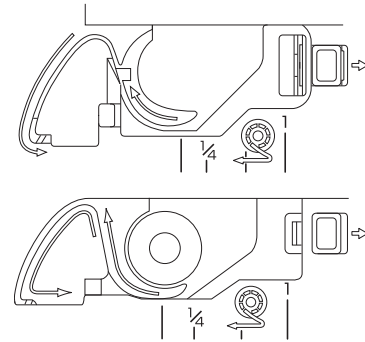

- 8 While lightly holding down the bobbin with your right hand (①), guide the thread through the slit in the needle plate cover (②) and lightly pull it with your left hand (③).

- The thread enters the tension spring of the bobbin case.

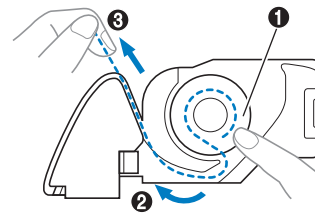

- 9 While lightly holding down the bobbin with your right hand (①), continue guiding the thread through the slit with your left hand (②). Then, cut the thread with the cutter (③).

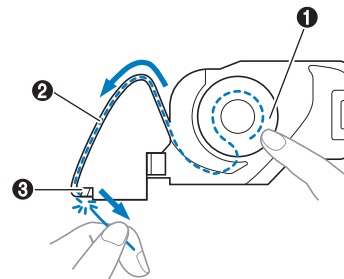

 **Note**

- If the thread is not correctly inserted through the tension-adjusting spring of the bobbin case, it may cause incorrect thread tension.

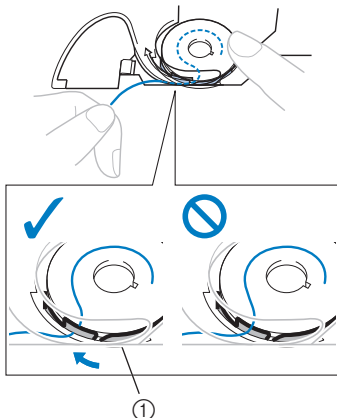

① Tension-adjusting spring

**10 Reattach the bobbin cover.**

Insert the tab of the bobbin cover into the notch of the needle plate cover, and then lightly press down on the right side.

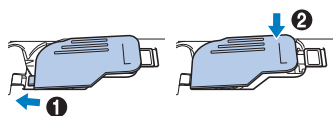

→ The bobbin threading is finished.

Next, thread the upper thread. Continue with the procedure in "Upper Threading" on page B-19.

 **Memo**

- You can begin sewing without pulling up the bobbin thread. If you wish to pull up the bobbin thread before starting to sew, pull up the thread according to the procedure in "Pulling up the bobbin thread" on page B-23.

## Upper Threading

**⚠ CAUTION**

- Three spool cap sizes are available, allowing you to choose a spool cap that best fits the size of spool being used. If the spool cap is too small for the spool being used, the thread may catch on the slit in the spool or the needle may break. When using mini king thread spool, use the thread spool insert (mini king thread spool). For more information regarding the choice of spool caps for your thread choice, see page B-14.

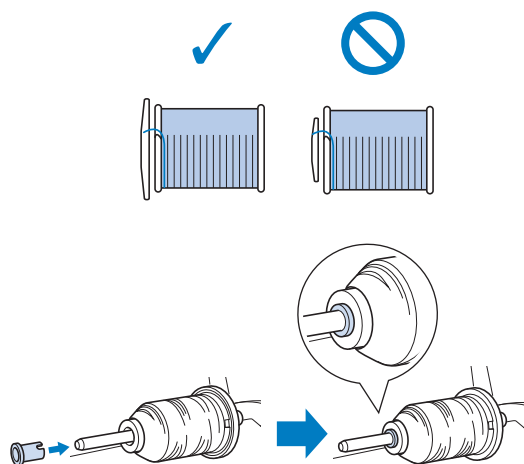

- When threading the upper thread, carefully follow the instructions. If the upper threading is not correct, the thread may become tangled or the needle may bend or break.
- Never use a thread weight of 20 or lower.
- Use the needle and the thread in the correct combination. For details on the correct combination of needles and threads, refer to "Fabric/Thread/Needle Combinations" on page B-26.

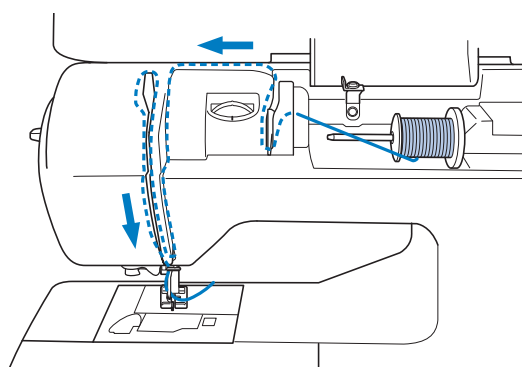
**Threading the upper thread**

When threading the upper thread, carefully follow the instructions.

- 1 Turn on the machine.
- 2 Raise the presser foot lever to raise the presser foot.

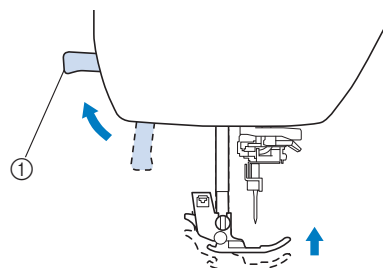

- ① Presser foot lever  
→ The upper thread shutter opens so the machine can be threaded.

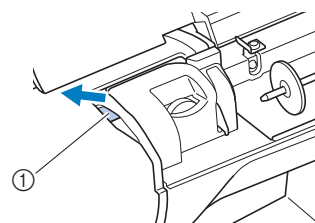



- ① Shutter

**Note**

- If the presser foot is not raised, the machine cannot be threaded.

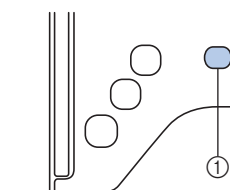
- 3 Press  (Needle position button) once or twice to raise the needle.



- ① Needle position button  
→ The needle is correctly raised when the mark on the handwheel is at the top, as shown below. Check the handwheel and, if this mark is not at this position, press  (Needle position button) until it is.

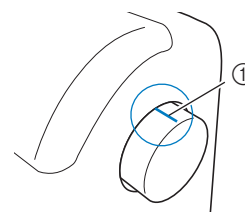

- ① Mark on handwheel

- 4 Turn off the machine.

- 5** Remove the spool cap that is inserted onto the spool pin.

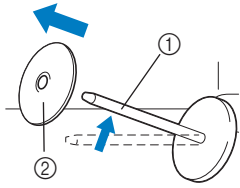

- ① Spool pin
- ② Spool cap

- 6** Place the spool of thread onto the spool pin.

Slide the spool onto the pin so that the spool is horizontal and the thread unwinds to the front at the bottom.

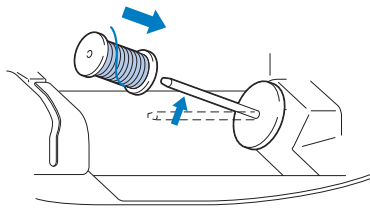

## ⚠ CAUTION

- If the spool or the spool cap is not positioned correctly, the thread may become tangled around the spool pin or the needle may break.

- 7** Slide the spool cap onto the spool pin.

Slide the spool cap as far as possible to the right, as shown, with the rounded side on the left.

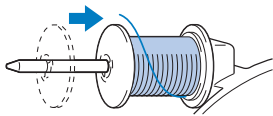

- 8** While holding the thread lightly with your right hand, pull the thread with your left hand, and then pass the thread behind the thread guide cover and to the front.

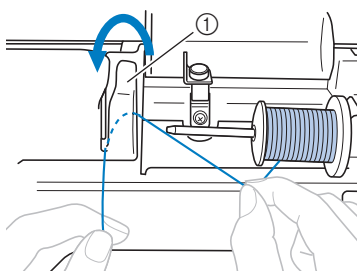

- ① Thread guide cover

- 9** While holding the thread lightly with your right hand, pass the thread under the thread guide plate, and then pull it up.

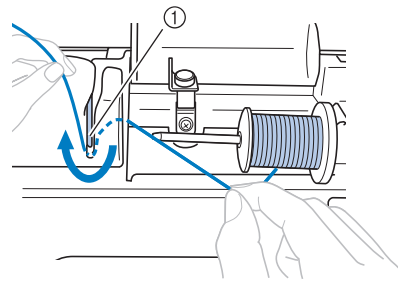

- ① Thread guide plate

- 10** Pass the thread through the thread channel in the order shown below.

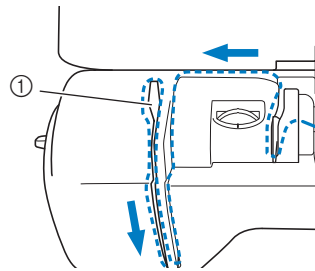

- ① Shutter



### Note

- If the presser foot has been lowered and the shutter is closed, the machine cannot be threaded. Be sure to raise the presser foot to open the shutter before threading the machine. In addition, before removing the upper thread, be sure to raise the presser foot to open the shutter.
- This machine is equipped with a window that allows you to check the position of the take-up lever. Look through this window and check that the thread is correctly fed through the take-up lever.

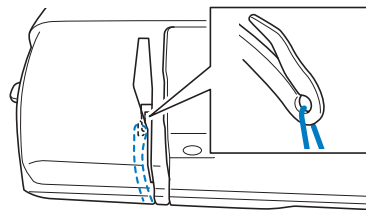

**11 Slide the thread behind the needle bar thread guide.**

The thread can easily be slid behind the needle bar thread guide by holding the thread in your left hand, then feeding the thread with your right hand, as shown. Make sure that the thread is passed through to the left of the tab of the needle bar thread guide.

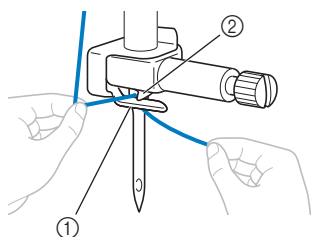

- ① Needle bar thread guide
- ② Tab

## Threading the needle

### Memo

- The needle threader can be used with machine needles 75/11 through 100/16.
- The needle threader cannot be used with the wing needle or the twin needle.
- When thread such as transparent nylon monofilament or specialty threads are used it is not recommended to use the needle threader.
- If the needle threader cannot be used, refer to “Threading the needle manually (without using the needle threader)” on page B-22.

**1 Pull the end of the thread, which has been passed through the needle bar thread guide, to the left, then pass the thread through the notch of the threader thread guide ①, and then firmly pull the thread from the front and insert it into the slit of the threader thread guide disk marked “7” all the way ②.**

- Make sure that the thread passes through the notch of the threader thread guide.

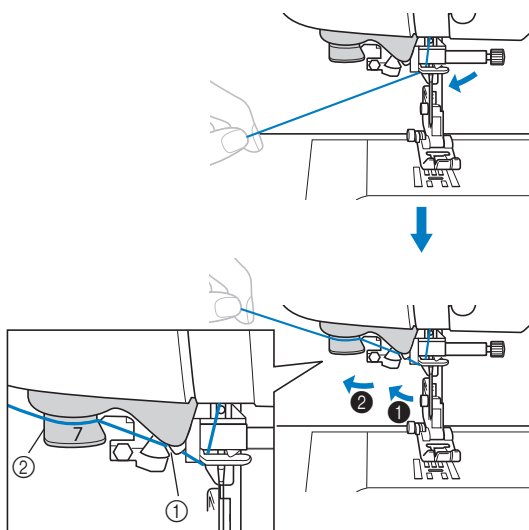

- ① Notch of the threader thread guide
- ② Threader thread guide disk

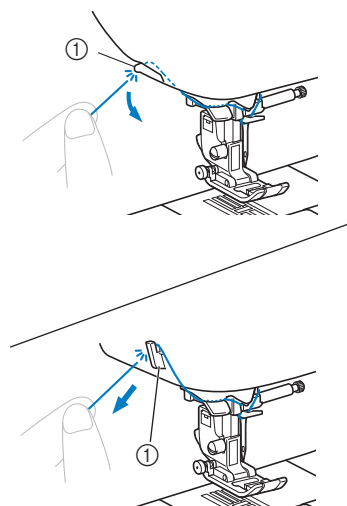
**2 Cut the thread with the thread cutter on the left side of the machine.**

- ① Cutter

### Note

- If the thread is pulled through and cannot be cut correctly, lower the presser foot lever so that the thread is held in place before cutting the thread. If this operation is performed, skip step ③.
- When using thread that quickly winds off the spool, such as metallic thread, it may be difficult to thread the needle if the thread is cut. Therefore, instead of using the thread cutter, pull out about 8 cm (approx. 3 inches) of thread after passing it through the threader thread guide disks (marked “7”).

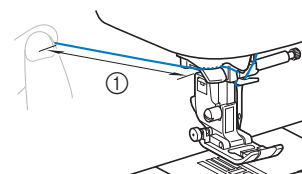

- ① 8 cm (approx. 3 inches) or more

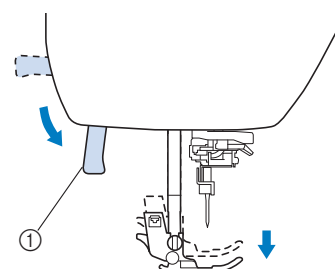
**3 Lower the presser foot lever to lower the presser foot.**

- ① Presser foot lever

- 4** Lower the needle threader lever on the left side of the machine until it clicks, and then slowly return the lever to its original position.

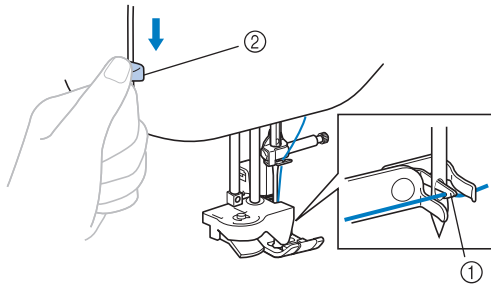

- ① Hook
- ② Needle threader lever

→ The hook is rotated and passes the thread through the eye of the needle.



**Note**

- If the needle is not raised to its highest position, the needle threader cannot thread the needle. Turn the handwheel counterclockwise until the needle is at its highest position. The needle is correctly raised when the mark on the handwheel is at the top, as shown under step 3 on page B-19.

- 5** Carefully pull the end of thread that was passed through the eye of the needle.

If the needle was not completely threaded, but a loop in the thread was formed in the eye of the needle, carefully pull the loop through the eye of the needle to pull out the end of the thread.

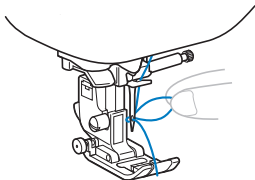

**⚠ CAUTION**

- When pulling out the thread, do not pull it with extreme force, otherwise the needle may break or bend.

- 6** Raise the presser foot lever, pass the end of the thread through and under the presser foot, and then pull out about 5 cm (approx. 2 inches) of thread toward the rear of the machine.

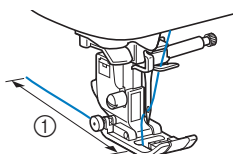

- ① 5 cm (approx. 2 inches)

**Threading the needle manually (without using the needle threader)**

When using specialty thread, such as transparent nylon thread, a wing needle or a twin needle which cannot be used with the needle threader, thread the needle as described below.

- 1** Thread the machine until you reach the eye of the needle.

- For details, refer to “Threading the upper thread” on page B-19.

- 2** Lower the presser foot lever.

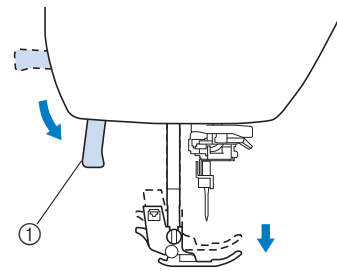

- ① Presser foot lever

- 3** Insert the thread through the eye of the needle from front to back.

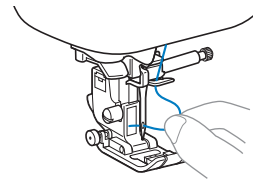

**⚠ CAUTION**

- Make sure you turn the power off while threading the needle manually. Otherwise injuries may occur if the “Start/Stop” button or any other button is pressed and the machine starts operating.

- 4** Raise the presser foot lever, pass the end of the thread through and under the presser foot, and then pull out about 5 cm (approx. 2 inches) of thread toward the rear of the machine.

## Pulling up the bobbin thread

When making gathers or before free motion quilting, first pull up the bobbin thread as described below.

- 1 Refer to “Threading the upper thread” (page B-19) to thread the machine with the upper thread and thread the needle.
- 2 Follow steps 4 to 6 “Installing the bobbin” (page B-16) for installing the bobbin to insert the bobbin into the bobbin case.
- 3 Pass the bobbin thread through the slot.  
Do not cut the thread with the cutter.

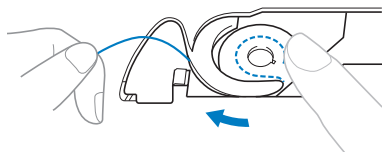

- 4 While lightly holding the upper thread with your left hand, press  (Needle position button) twice to lower and then raise the needle.

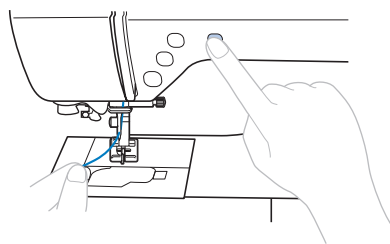

→ The bobbin thread is looped around the upper thread and can be pulled up.

- 5 Carefully pull the upper thread upward to pull out the end of the bobbin thread.

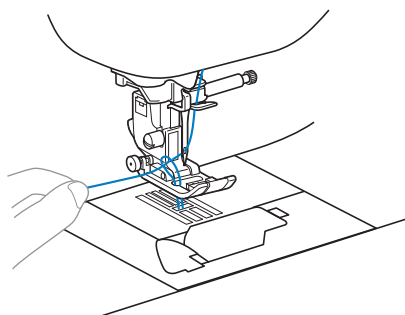

- 6 Pull up the bobbin thread, pass it under the presser foot and pull it about 10 cm (4 inches) toward the back of the machine, making it even with the upper thread.

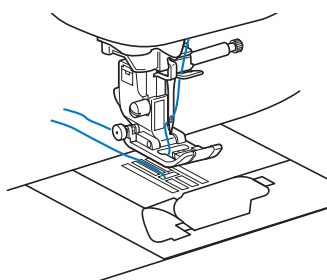

- 7 Reattach the bobbin cover.

Insert the tab of the bobbin cover into the notch of the needle plate cover, and then lightly press down on the right side.

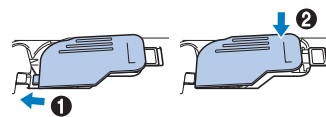

## Using the twin needle

With the twin needle, you can sew two parallel lines of the same stitch with two different threads. Both upper threads should have the same thickness and quality. Be sure to use the twin needle, the horizontal spool pin and the appropriate spool cap.

For details on the stitches that can be sewn with the twin needle, refer to “Stitch Setting Chart” beginning on page B-42.

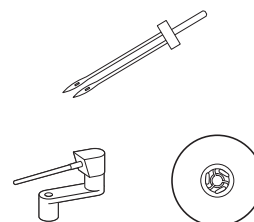

### Memo

- Traditionally a twin needle is also used for creating pin tucks. Contact your nearest authorized Brother dealer to obtain the optional pin tuck foot for your machine (SA194, F069: XF5832-001).

## CAUTION

- Only use the twin needle (2/11 needle). Use of any other needle may bend the needle or damage the machine.
- Never use bent needles. Bent needles can easily break, possibly resulting in injuries.
- The needle threader cannot be used with the twin needle. If the needle threader is used with the twin needle, the machine may be damaged.

- 1 Install the twin needle.

- For details on installing a needle, refer to “Replacing the needle” on page B-27.

- 2 Thread the upper thread for the left needle eye.

- For details, refer to steps 1 through 11 of “Threading the upper thread” on page B-19.



- 3** **Manually thread the left needle with the upper thread.**  
 Pass the thread through the eye of the needle from the front.

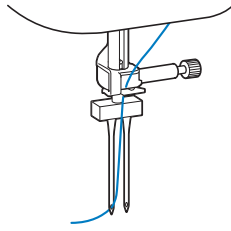

- 4** **Insert the horizontal spool pin onto the bobbin winder shaft.**  
 Insert the horizontal spool pin so that it is perpendicular to the bobbin winder shaft.

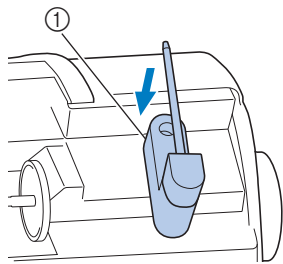

① Bobbin winder shaft

- 5** **Swing the spool pin toward the left so that it is horizontal.**

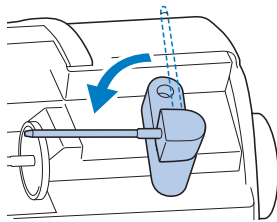

- 6** **Place the upper thread spool for the needle on the right side onto the horizontal spool pin, and then secure it with the spool cap.**  
 The thread should unwind from the front at the bottom of the spool.

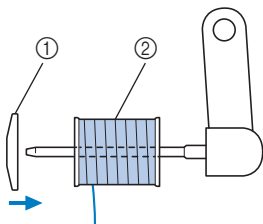

① Spool cap  
 ② Spool

- 7** **Thread the upper thread in the same way that the upper thread for the left side was threaded.**

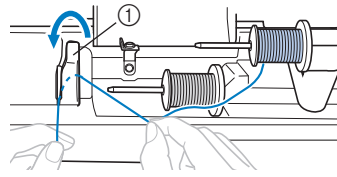

- ① Thread guide cover  
 • For details, refer to steps **8** through **10** of “Threading the upper thread” on page B-19.

- 8** **Without passing the thread through the needle bar thread guide, manually thread the right needle.**

Insert the thread through the eye of the needle from the front to the back.

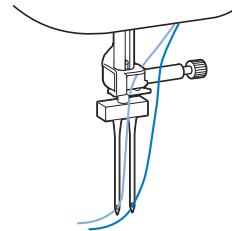

- The needle threader cannot be used with the twin needle. If the needle threader is used with the twin needle, the machine may be damaged.

- 9** **Attach zigzag foot “J”.**

- For details on changing the presser foot, refer to “Replacing the presser foot” on page B-29.

## ⚠ CAUTION

- When using the twin needle, be sure to attach zigzag foot “J”. If bunched stitches occur, use monogramming foot “N” or attach stabilizer material.

- 10** **Turn on the machine and select a stitch.**

- For stitch selection see “Selecting a stitch pattern” on page B-32.
- See “Stitch Setting Chart” on page B-42 for stitches that use a twin needle.

## ⚠ CAUTION

- When using the twin needle, be sure to select an appropriate stitch, otherwise the needle may break or the machine may be damaged.



- 11 Press  to turn on the twin needle mode.

Make sure that  appears on the LCD.

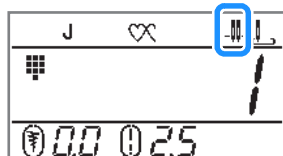

## CAUTION

- When using the twin needle, be sure to select the twin needle setting, otherwise the needle may break or the machine may be damaged.

- 12 Start sewing.

- For details on starting to sew, refer to “STARTING TO SEW” on page B-31.

→ Two lines of stitching are sewn parallel to each other.

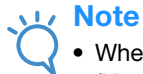
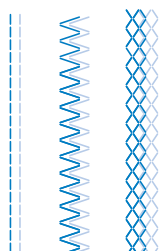

### Note

- When changing the sewing direction, press  (Needle position button) to raise the needle from the fabric, and then raise the presser foot lever and turn the fabric.

## CAUTION

- Do not try turning the fabric while the twin needle is down in the fabric, otherwise the needle may break or the machine may be damaged.

## Fabric/Thread/Needle Combinations

- **Needles that can be used with this machine: Home sewing machine needles (size 65/9 - 100/16)**  
\* The larger the number, the larger the needle. As the numbers decrease, the needles get finer.
- **Thread that can be used with this machine: 30 - 90 weight**  
\* Never use thread of 20 weight or lower. It may cause machine to malfunction.  
\* The smaller the number, the heavier the thread. As the numbers increase, the thread gets finer.
- **The machine needle and thread that should be used depends on the type and thickness of the fabric. Refer to the following table when choosing the thread and needle appropriate for the fabric that you wish to sew.**
  - The combinations shown in the table provide a general guideline. Be sure to sew trial stitches on the actual number of layers and type of fabric to be used in your project.
  - The machine needles are consumables. For safety and best results, we recommend replacing the needle regularly. For details on when to replace the needle, refer to "Checking the needle" on page B-27.
- **In principle, use a fine needle and thread with lightweight fabrics, and a larger needle and heavier thread with heavyweight fabrics.**
- **Select a stitch appropriate for the fabric, and then adjust the stitch length. When sewing lightweight fabrics, make the stitch length finer (shorter). When sewing heavyweight fabrics, make the stitch length coarser (longer). (page B-38)**  
When sewing stretch fabrics, refer to "Sewing stretch fabrics" in the "Sewing" section.

Fabric Type/Application		Thread		Size of needle	Stitch length [mm (inch)]
		Type	Weight		
Lightweight fabrics	Lawn, georgette, challis, organdy, crepe, chiffon, voile, gauze, tulle, lining, etc.	Polyester thread	60 - 90	65/9 - 75/11	Fine stitches 1.8-2.5 (1/16-3/32)
		Cotton thread, Silk thread	50 - 80		
Medium weight fabrics	Broadcloth, taffeta, gabardine, flannel, seersucker, double gauze, linen, terry cloth, waffle weave, sheeting, poplin, cotton twill, satin, quilting cotton, etc.	Polyester thread	60 - 90	75/11 - 90/14	Regular stitches 2.0-3.0 (1/16-1/8)
		Cotton thread, Silk thread	50 - 60		
Heavyweight fabrics	Denim (12 ounces or more), canvas, etc.	Polyester thread, Cotton thread	30	100/16	Coarse stitches 2.5-4.0 (3/32-3/16)
	Denim (12 ounces or more), canvas, tweed, corduroy, velour, melton wool, vinyl-coated fabric, etc.	Polyester thread	60	90/14 - 100/16	
		Cotton thread, Silk thread	30 - 50		
Stretch fabrics (knit fabrics, etc.)	Jersey, tricot, T-shirt fabric, fleece, interlock, etc.	Cotton thread, Polyester thread, Silk thread	50	Ball point needle 75/11 - 90/14	Setting appropriate for the fabric thickness
For top-stitching		Polyester thread, Cotton thread	30	90/14 - 100/16	Setting appropriate for the fabric thickness
			50 - 60	75/11 - 90/14	

### ■ Transparent nylon thread

Use a home sewing machine topstitching needle, regardless of the fabric.

## ⚠ CAUTION

- The appropriate fabric, thread and needle combinations are shown in the preceding table. If the combination of the fabric, thread and needle is not correct, particularly when sewing heavy fabrics (such as denim) with thin needles (such as 65/9 to 75/11), the needle may bend or break. In addition, the stitching may be uneven or puckered or there may be skipped stitches.

## Replacing the Needle

Be sure to observe the following precautions concerning the handling of the needle. Failure to observe these precautions is extremely dangerous, for example, if the needle breaks and fragments are dispersed. Be sure to read and carefully follow the instructions below.

### ⚠ CAUTION

- Only use recommended home sewing machine needles. Use of any other needle may bend the needle or damage the machine.
- Never use bent needles. Bent needles can easily break, possibly resulting in injuries.

### Checking the needle

Sewing with a bent needle is extremely dangerous since the needle may break while the machine is being operated.

Before using the needle, place the flat side of the needle on a flat surface and check that the distance between the needle and the flat surface is even.

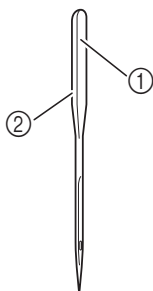

- ① Flat side
- ② Needle type marking

### ⚠ CAUTION

- If the distance between the needle and the flat surface is not even, the needle is bent. Do not use a bent needle.

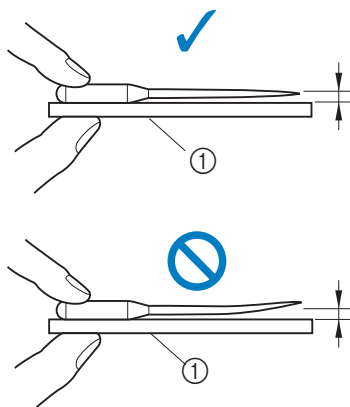

- ① Flat surface



#### Note

- Replace the needle in cases such as the four described below:
  - ① If an unusual sound is produced when the needle enters the fabric while sewing trial stitches at low speed. (The tip of the needle may be broken.)
  - ② If stitches are skipped. (The needle may be bent.)
  - ③ After completing one project, such as a piece of clothing.
  - ④ After using three full bobbins of thread.

### Replacing the needle

Use the screwdriver and a needle that has been determined to be straight according to the instructions in "Checking the needle".

- 1 Press  (Needle position button) once or twice to raise the needle.
- 2 Turn off the machine.

### ⚠ CAUTION

- Before replacing the needle, be sure to turn off the machine, otherwise injuries may occur if the "Start/Stop" button or any other button is pressed and the machine starts operating.

- 3 Place fabric or paper under the presser foot to cover the hole in the needle plate.



#### Note

- Before replacing the needle, cover the hole in the needle plate with fabric or paper to prevent the needle from falling into the machine.

- 4 Lower the presser foot.

**5** Hold the needle with your left hand, and then use a screwdriver to turn the needle clamp screw toward you (counterclockwise) to remove the needle.

- The needle clamp screw can also be loosened or tightened with the disc-shaped (or L-shaped) screwdriver.

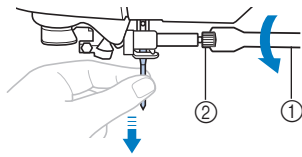

- ① Screwdriver
- ② Needle clamp screw

- Do not apply a strong force when loosening or tightening the needle clamp screw, otherwise certain parts of the machine may be damaged.

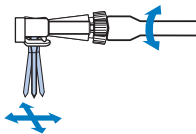

**6** With the flat side of the needle toward the rear of the machine, insert the needle until it touches the needle stopper.

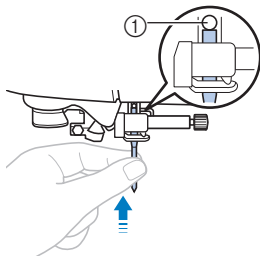

- ① Needle stopper

**7** While holding the needle with your left hand, use the screwdriver to tighten the needle clamp screw.

Turn the screw toward the back of the machine (clockwise).

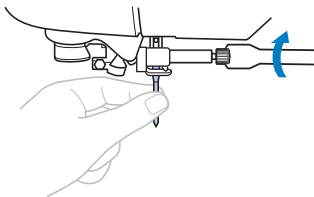

## **⚠ CAUTION**

- Be sure to insert the needle until it touches the needle stopper and securely tighten the needle clamp screw with the screwdriver, otherwise the needle may break or damage may result.

# Replacing the Presser Foot

## ⚠ CAUTION

- Use the presser foot appropriate for the type of stitch that you wish to sew, otherwise the needle may hit the presser foot, causing the needle to bend or break.
- Use presser feet designed specifically for this machine.

### Replacing the presser foot

- 1 Press  (Needle position button) once or twice to raise the needle.
- 2 Turn off the machine.

## ⚠ CAUTION

- Before replacing the presser foot, be sure to turn off the machine, otherwise injuries may occur if the “Start/Stop” button or any other button is pressed and the machine starts operating.

- 3 Raise the presser foot lever, if necessary.
- 4 Press the black button at the back of the presser foot holder.

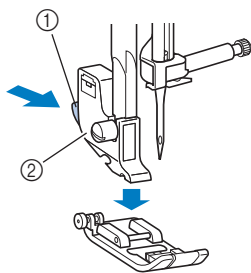

- ① Black button
- ② Presser foot holder

- 5 Place a different presser foot below the holder so that the presser foot pin is aligned with the notch in the holder.

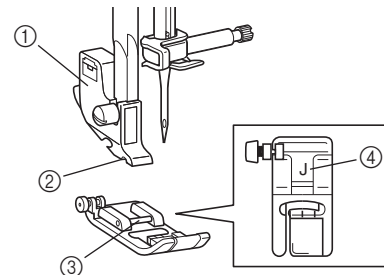

- ① Presser foot holder
- ② Notch
- ③ Pin
- ④ Presser foot type

- 6 Slowly lower the presser foot lever so that the presser foot pin snaps into the notch in the presser foot holder.

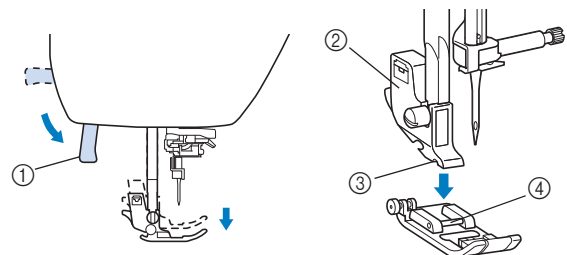

- ① Presser foot lever
  - ② Presser foot holder
  - ③ Notch
  - ④ Pin
- The presser foot is attached.

- 7 Raise the presser foot lever to check that the presser foot is securely attached.

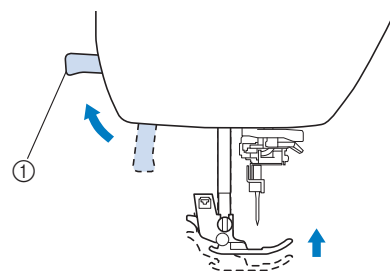

- ① Presser foot lever



**Note**

- When a stitch is selected, the icon for the presser foot that should be used appears in the screen. Check that the correct presser foot is attached before starting to sew. If the wrong presser foot is installed, turn off the machine, attach the correct presser foot, turn machine back on and then select the desired stitch again.

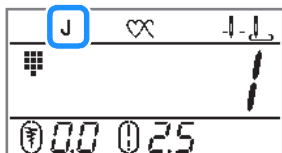

<b>J</b>	Zigzag foot "J"
<b>N</b>	Monogramming foot "N"
<b>G</b>	Overcasting foot "G"
<b>A</b>	Buttonhole foot "A"
<b>R</b>	Blind stitch foot "R"
<b>M</b>	Button fitting foot "M"
<b>S</b>	Side cutter "S"

- For details on the presser foot that should be used with the selected stitch, refer to "Stitch Setting Chart" on page B-42.

### Removing and attaching the presser foot holder

Remove the presser foot holder when cleaning the machine or when installing a presser foot that does not use the presser foot holder, such as the walking foot and quilting foot. Use the screwdriver to remove the presser foot holder.

- 1 Turn off the machine.**
- 2 Remove the presser foot.**
  - For details, refer to "Replacing the presser foot" on page B-29.
- 3 Use the screwdriver to loosen the presser foot holder screw.**

Turn the screw toward the back of the machine (counterclockwise).

- The presser foot holder screw can also be loosened or tightened with the disc-shaped (or L-shaped) screwdriver.

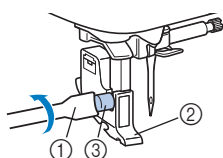

- ① Screwdriver
- ② Presser foot holder
- ③ Presser foot holder screw

### Attaching the presser foot holder

- 1 Turn off the machine.**
- 2 Raise the presser foot lever.**
- 3 Align the presser foot holder with the lower-left side of the presser bar.**

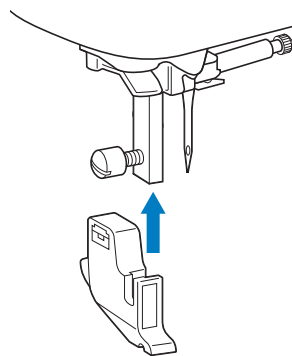

- 4 Hold the presser foot holder in place with your right hand, and then tighten the screw using the screwdriver in your left hand.**

Turn the screw toward you (clockwise).

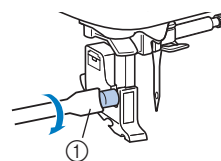

- ① Screwdriver

## CAUTION

- Be sure to securely tighten the presser foot holder screw, otherwise the presser foot holder may fall off and the needle may strike it, causing the needle to bend or break.



**Note**

- If the presser foot holder is not correctly installed, the thread tension will be incorrect.

# Chapter 2 STARTING TO SEW

B

STARTING TO SEW

## Sewing

### ⚠ CAUTION

- While the machine is in operation, pay special attention to the needle location. In addition, keep your hands away from all moving parts such as the needle and handwheel, otherwise injuries may occur.
- Do not pull or push the fabric too hard while sewing, otherwise injuries may occur or the needle may break.
- Never use bent needles. Bent needles can easily break, possibly resulting in injuries.
- Make sure that the needle does not strike basting pins, otherwise the needle may break or bend.

### Stitch selection methods

A stitch can be selected from the following methods available.

Stitch patterns can be selected through either direct select (by pressing the designated key for a specific stitch) or number selection (by entering the number for the stitch pattern).

For details on the types of stitches available, refer to the Quick Reference Guide.



#### ■ Direct selection

With direct selection, there are two stitch modes listed below. Each press of  switches the modes.

##### Preset utility stitch

-  The most frequently used utility stitches have been assigned to the numeric keys. These stitches can be selected simply by pressing the designated key. For details, refer to “Preset utility stitches” on page B-46.

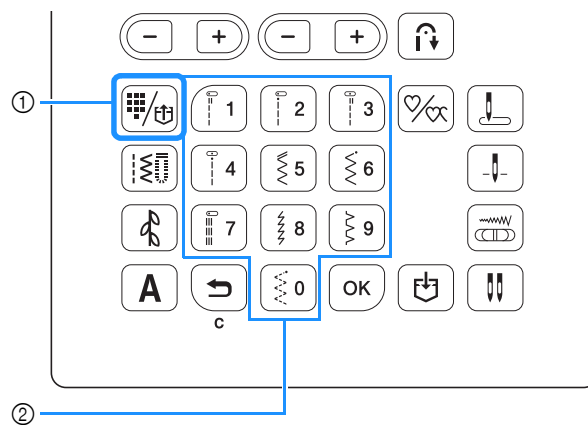

##### Saved patterns

-  Frequently used patterns and combined patterns can be saved in the machine’s memory and easily retrieved using  (Preset utility stitch/saved pattern key). For details, refer to “Saving a pattern” and “Retrieving a pattern” in the “Decorative sewing” section.



- ① Preset utility stitch/saved pattern key
- ② Numeric keys

#### ■ Number selection

After pressing  (Utility stitch key),  (Decorative stitch key) or  (Character stitch key) to select the stitch mode, use the numeric keys to type in the number for the desired stitch.

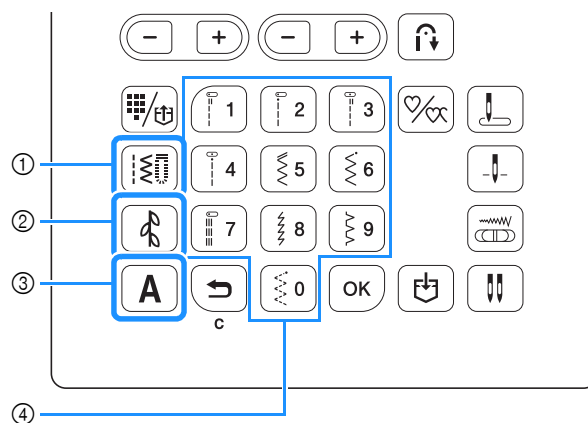

- ① Utility stitch key
- ② Decorative stitch key
- ③ Character stitch key
- ④ Numeric keys

##### Utility stitches

 There are various utility stitches, including straight stitches, overcasting stitches and buttonhole stitches.

##### Decorative stitches

 There is one decorative stitch mode. For details, refer to “Selecting stitch patterns” in the “Decorative sewing” section.

□ **A** Character stitches

There are four character stitch modes:

**A 1**, Gothic font mode

**A 2**, Handwriting font mode

**A 3**, Outline font mode

**A 4**, Japanese font mode

For details, refer to “Selecting stitch patterns” in the “Decorative sewing” section.

## Selecting a stitch pattern

### ■ When selecting a utility stitch

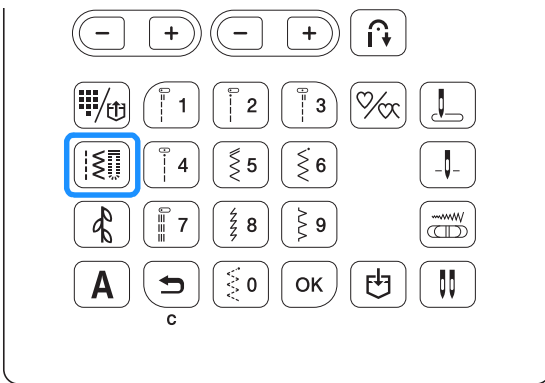

1 Press .

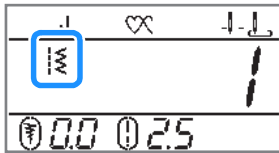

→  is displayed on the LCD screen.



2 Enter the number of the desired stitch using numeric keys, and then press .

- For number of each stitch, refer to “Stitch Setting Chart” on page B-42 or the Quick Reference Guide.
  - Depending on the stitch number, the stitch may be selected without pressing .
  - When using one-digit numbers and it is entered incorrectly, press  to erase the entered number.
- The selected stitch number is displayed on the LCD screen.

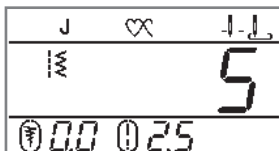

### ■ When selecting from the preset utility stitches

Since various stitches have been assigned to the numeric keys, these stitches can be selected simply by pressing the designated numeric key.

1 Check that  appears on the screen.

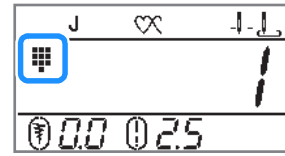

If a different icon is displayed, press .

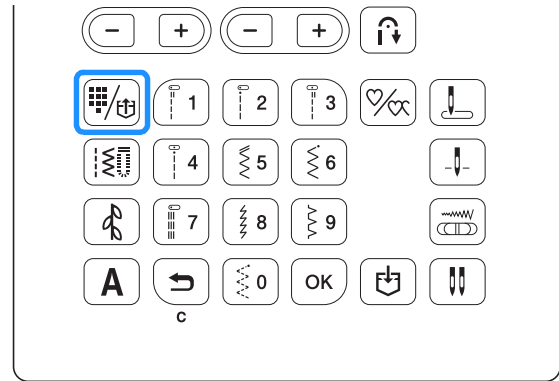

2 Press the numeric key on which the desired stitch is printed.

### ■ When selecting a character/decorative stitch

After pressing  or **A** on the operation panel the necessary number of times, enter a number.

For more details, refer to “Selecting stitch patterns” in the “Decorative sewing” section.



## Sewing a stitch

- 1 Turn the main power to ON and press  (Needle position button) to raise the needle.
- 2 Select the desired stitch following the procedure described in “Selecting a stitch pattern” on page B-32.
- 3 If necessary, specify the setting for automatic reverse/reinforcement stitching and adjust the stitch length, etc.
  - For details on adjusting the stitch width and length, refer to “Setting the stitch width” on page B-38 and “Setting the stitch length” on page B-38.
- 4 Install the presser foot.
  - For details on changing the presser foot, refer to “Replacing the Presser Foot” on page B-29.



### Note

- When a stitch is selected, the icon for the presser foot that should be used appears on the screen. Check that the correct presser foot is attached before starting to sew. If the wrong presser foot is installed, turn off the machine, attach the correct presser foot, turn machine back on and then select the desired stitch again.

## ⚠ CAUTION

- Always use the correct presser foot. If the wrong presser foot is used, the needle may strike the presser foot and bend or break, possibly resulting in injury. Refer to page B-42 for presser foot recommendations.

- 5 Set the fabric under the presser foot. Hold the fabric and thread with your left hand, and rotate the handwheel counterclockwise or press  (Needle position button) to set the needle in the sewing start position.

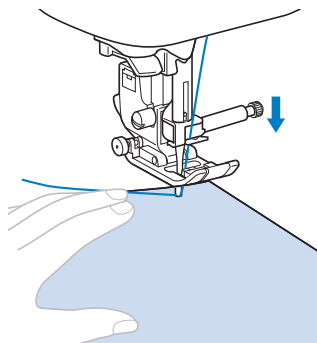

### Memo

- The black button on the left side of zigzag foot “J” should be pressed only if the fabric does not feed or when sewing over thick seams. For details, refer to “Sewing thick fabrics” in the “Sewing” section. Normally, you can sew without pressing the black button.

- 6 Lower the presser foot.
  - You do not have to pull up the bobbin thread.
- 7 Adjust the sewing speed with the sewing speed controller.
  - You can use this controller to adjust sewing speed during sewing.

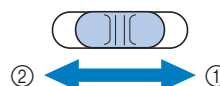

- ① Fast
- ② Slow

- 8 Press the “Start/Stop” button to start sewing.
  - Guide the fabric lightly by hand.

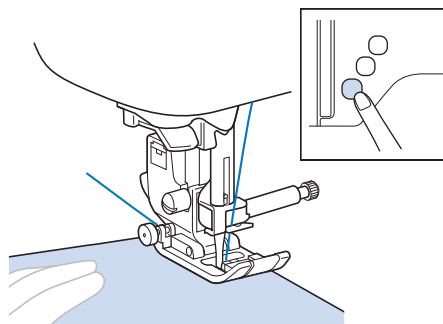

### Memo

- When the foot controller is being used, you cannot start sewing by pressing the “Start/Stop” button.

- 9 Press the “Start/Stop” button again to stop sewing.

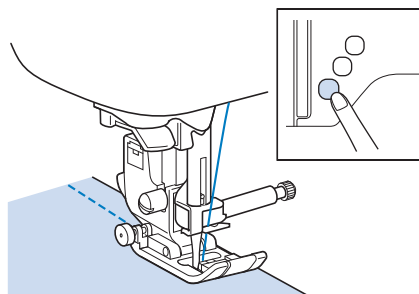

**10 Trim the upper and lower threads.**

**■ When using the thread cutter**

When using the thread cutter on the left side of the machine or scissors to cut the threads, press  (Needle position button) to raise the needle, raise the presser foot, and then pull out the fabric before cutting the threads.

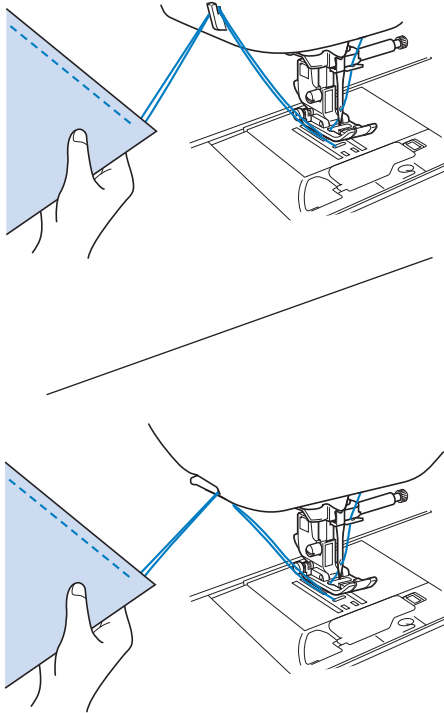

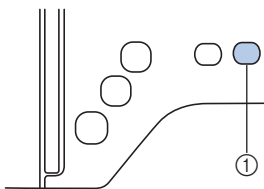

**■ When the thread cutter button is used (only on models with a thread cutter button)**

Press .



- ① Thread cutter button
- The needle will return to the up position automatically.

**⚠ CAUTION**

- Do not press  (Thread cutter button) after the threads have been cut. Doing so could tangle the thread or break the needle and damage the machine.
- Do not press  (Thread cutter button) when there is no fabric set in the machine or during machine operation. The thread may tangle, possibly resulting in damage.

**Note**

- When cutting thread such as nylon monofilament thread, or other decorative threads, use the thread cutter on the side of the machine.

**11 When the needle has stopped moving, raise the presser foot and remove the fabric.**

**■ Using the foot controller**

You can also use the foot controller to start and stop sewing.

**⚠ CAUTION**

- Do not allow fabric pieces and dust to collect in the foot controller. Doing so could cause a fire or an electric shock.

**Memo**

- When the foot controller is being used, you cannot start sewing by pressing the “Start/Stop” button.
- Bobbin winding can be started and stopped with the foot controller.

**1 Turn off the machine.**

**2 Insert the foot controller plug into its jack on the machine.**

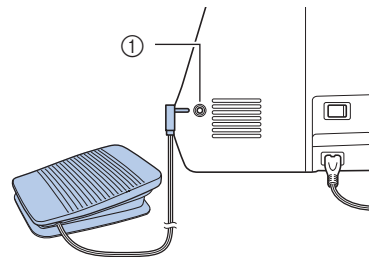

① Foot controller jack

**3 Turn on the machine.**

**4 Slowly depress the foot controller to start sewing.**

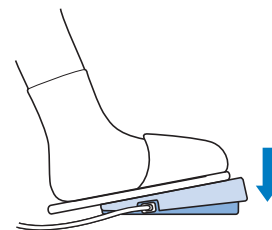



**Memo**

- The speed that is set using the sewing speed controller will be the foot controller’s maximum sewing speed.

**5 Release the foot controller to stop the machine.**



## Sewing reinforcement stitches

Reverse/reinforcement stitches are generally necessary at the beginning and end of sewing. You can use  (Reverse stitch button) to sew reverse/reinforcement stitches (Refer to “Stitch Setting Chart” under the column for “Reverse button” on page B-42.).

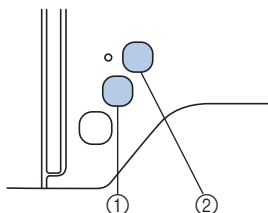
While pressing , the machine will sew 3 to 5 reinforcement stitches at that point and then stop.



- ① Reverse stitch button
- ② Reinforcement stitch button

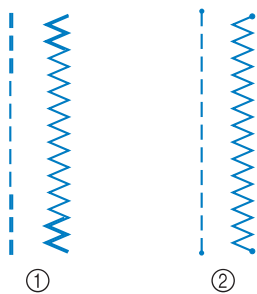

If the automatic reinforcement stitch is selected, reverse stitches (or reinforcement stitches) will be sewn automatically at the beginning of sewing when the “Start/Stop” button is pressed. Press  (Reverse stitch button) or  (Reinforcement stitch button) to sew reverse stitches or reinforcement stitches automatically at the end of sewing.



- ① Reverse stitch
- ② Reinforcement stitch

The operation performed when the button is pressed differs depending on the selected pattern. Refer to the table in “Automatic reinforcement stitching” on page B-35.

### Memo

- While pressing  (Reinforcement stitch button) when sewing character/decorative stitch pattern, you can end sewing with a completed motif instead of at the midpoint of a stitch motif.
- The green light on the left of  (Reinforcement stitch button) lights up while the machine is sewing a full motif, and it automatically turns off when the sewing is stopped.

## Automatic reinforcement stitching

After selecting a stitch motif, turn on the automatic reinforcement stitching function before sewing, and the machine will automatically sew reinforcement stitches (or reverse stitches, depending on the stitch motif) at the beginning and end of sewing. Refer to the table on page B-36.

- 1 Select a stitch pattern.
- 2 Press  to set the automatic reinforcement stitching function.

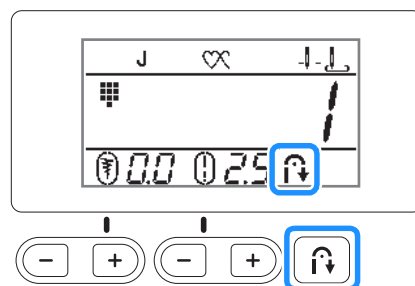

→  appears on the LCD.

- 3 Set the fabric in the start position and begin sewing.

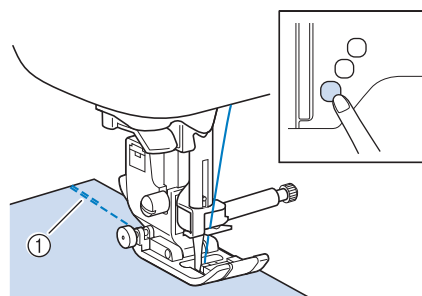

- ① Reverse stitches (or reinforcement stitches)
- The machine will automatically sew reverse stitches (or reinforcement stitches) and then continue sewing.

### Memo

- When selecting the stitches below, the machine will automatically sew reverse stitches at the beginning of the stitch.



- If you press the “Start/Stop” button to pause sewing, press it again to continue. The machine will not sew reverse/reinforcement stitches again.

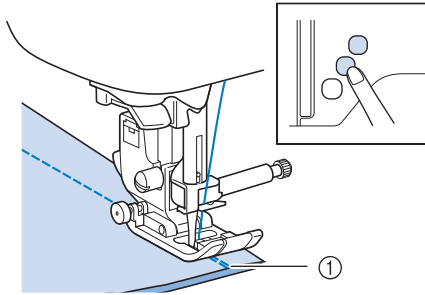

**4** Press  (Reverse stitch button) or  (Reinforcement stitch button).







- ① Reverse stitches (or reinforcement stitches)
- The machine will sew reverse stitches (or reinforcement stitches) and stop.





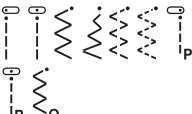

**Memo**

- To turn off the automatic reinforcement stitching function, press  so that  in the LCD screen is no longer displayed.

The operation performed when the button is pressed differs depending on the selected pattern. Refer to the following table for details on the operation that is performed when the button is pressed.

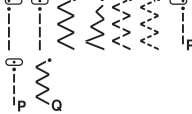

	Reverse stitch button 	Reinforcement stitch button 
When the automatic reinforcement stitching function is not active while selecting stitches such as examples shown below: 	Machine starts sewing the stitches and only sews reverse stitches while holding the Reverse stitch button.	Machine sews 3 - 5 reinforcement stitches while holding the Reinforcement stitch button.
When the automatic reinforcement stitching function is active while selecting stitches such as examples shown below: 	Machine sews reverse stitches at the beginning and end of sewing.	Machine sews reverse stitches at the beginning and reinforcement stitches at the end of sewing.
When the automatic reinforcement stitching function is not active while selecting stitches such as examples shown below: 	Machine starts sewing the stitches and only sews reverse stitches while holding the Reverse stitch button.*	Machine starts sewing the stitches and sews 3 - 5 reinforcement stitches while holding the Reinforcement stitch button.

	Reverse stitch button 	Reinforcement stitch button 
When the automatic reinforcement stitching function is active while selecting stitches such as examples shown below: 	Machine sews reinforcement stitches at the beginning and reverse stitches at the end of sewing.*	Machine sews reinforcement stitches at the beginning and end of sewing.
When the automatic reinforcement stitching function is not active while selecting utility stitches other than the straight or zigzag stitches.	Machine sews 3 - 5 reinforcement stitches while holding the Reverse stitch button.	Machine sews 3 - 5 reinforcement stitches while holding the Reinforcement stitch button.
When the automatic reinforcement stitching function is active while selecting utility stitches other than the straight or zigzag stitches.	Machine sews reinforcement stitches at the beginning and end of sewing.	Machine sews reinforcement stitches at the beginning and end of sewing.
When the automatic reinforcement stitching function is not active while selecting character/ decorative stitches.	Machine starts sewing and then sews reinforcement stitches while holding the Reverse stitch button.	Machine starts sewing at the beginning, then completes the pattern when the Reinforcement stitch button is pressed and sews reinforcement stitches at the end of sewing.
When the automatic reinforcement stitching function is active while selecting character/ decorative stitches.	Machine sews reinforcement stitches at the beginning and sews reinforcement stitches when the Reverse stitch button is pressed.	Machine sews reinforcement stitches at the beginning, then completes the pattern when the Reinforcement stitch button is pressed and sews reinforcement stitches at the end of sewing.

\* If  (Reinforcement priority) in the settings screen is turned on, reinforcement stitches are sewn instead of reverse stitches. Refer to "Reinforcement priority" on page B-37.

## Reinforcement priority

When set to "ON" within the settings screen, reinforcement stitches are sewn at the beginning and/or end of sewing reinforcement stitch patterns, even if  (Reverse stitch button) has been pressed. For details, refer to "Automatic reinforcement stitching" on page B-35.

- 1 Turn off the machine.
- 2 While pressing  (Reinforcement stitch button) on the operation panel, turn on the sewing machine.
- 3 Press the "-" or "+" key to select " !".

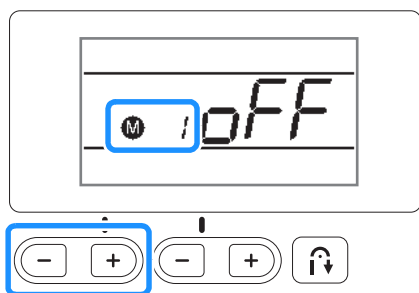

- 4 Press the "-" or "+" key to set to "ON".

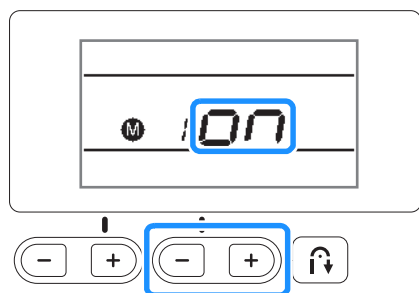

- 5 Turn off the machine, then turn it on again.

## Setting the Stitch

This machine is preset with the default settings for the stitch width and stitch length for each stitch. However, you can change their settings or adjust them by following the procedure described in this section.

### Setting the stitch width

The stitch width (zigzag width) can be adjusted to make the stitch wider or narrower.

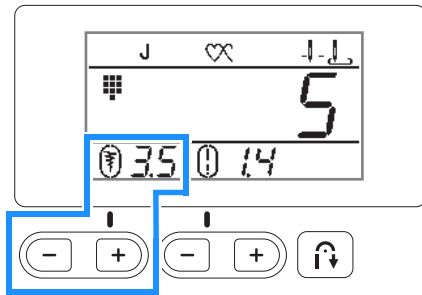



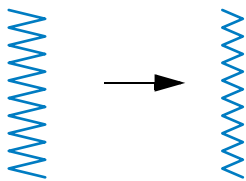

Each press of “-” makes the zigzag stitch narrower.

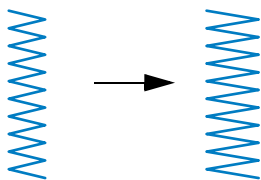

Each press of “+” makes the zigzag stitch wider.



#### Memo

- If the straight stitch or triple stretch stitch was selected, changing the stitch width changes the needle position. Increasing the width moves the needle to the right; reducing the width moves the needle to the left.
- When the stitch width is changed from the standard setting,  around  disappears. When the stitch width is reset back to the standard setting,  reappears around .
-  means the setting cannot be adjusted.

## CAUTION

- After adjusting the stitch width, slowly turn the handwheel toward you (counterclockwise) and check that the needle does not touch the presser foot. If the needle hits the presser foot, the needle may bend or break.

### Setting the stitch length

The stitch length can be adjusted to make the stitch coarser (longer) or finer (shorter).

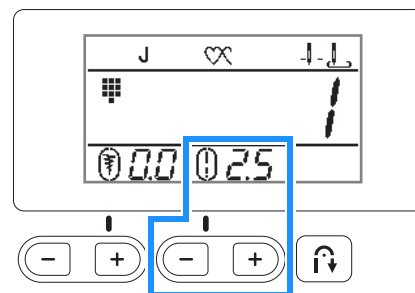



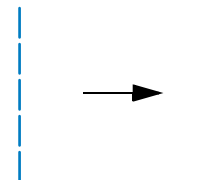

Each press of “-” makes the stitch length finer (shorter).

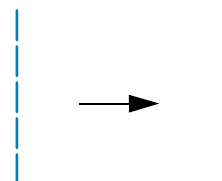

Each press of “+” makes the stitch length coarser (longer).



#### Memo

- When the stitch length is changed from the standard setting,  around  disappears. When the stitch length is reset back to the standard setting,  reappears around .
-  means the setting cannot be adjusted.

## Setting the thread tension

You may need to change the thread tension, depending on the fabric and thread being used.

### ■ Correct thread tension

The upper thread and the bobbin thread should cross near the center of the fabric. Only the upper thread should be visible from the right side of the fabric, and only the bobbin thread should be visible from the wrong side of the fabric.

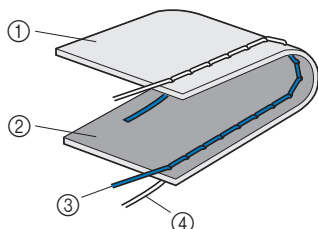

- ① Wrong side of fabric
- ② Right side of fabric
- ③ Upper thread
- ④ Bobbin thread

### ■ Upper thread is too tight

If the bobbin thread is visible from the right side of the fabric, the upper thread is too tight. Loosen the thread tension.



#### Note

- If the bobbin thread was incorrectly threaded, the upper thread may be too tight. In this case, refer to “Installing the bobbin” on page B-16 and rethread the bobbin thread.

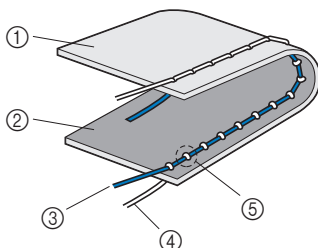

- ① Wrong side of fabric
- ② Right side of fabric
- ③ Upper thread
- ④ Bobbin thread
- ⑤ The bobbin thread is visible from the right side of the fabric.

Pushing the thread tension dial toward the left makes the thread tension looser.

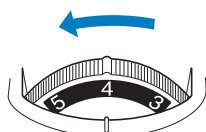

### ■ Upper thread is too loose

If the upper thread is visible from the wrong side of the fabric, the upper thread is too loose.

Tighten the thread tension.



#### Note

- If the upper thread was incorrectly threaded, the upper thread may be too loose. In this case, refer to “Upper Threading” on page B-19 and rethread the upper thread.

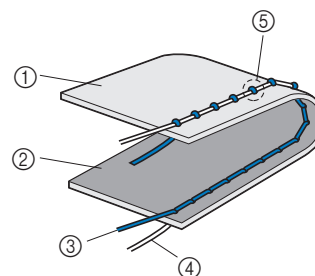

- ① Wrong side of fabric
- ② Right side of fabric
- ③ Upper thread
- ④ Bobbin thread
- ⑤ The upper thread is visible from the wrong side of the fabric.

Pushing the thread tension dial toward the right makes the thread tension tighter.

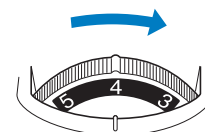

#### Note

- If the upper thread is not threaded correctly or the bobbin is not installed correctly, it may not be possible to set the correct thread tension. If the correct thread tension cannot be achieved, rethread the upper thread and insert the bobbin correctly.

## Useful Functions

### Automatically cutting the thread (Only on models with automatic thread cutting key)

The machine can be set to automatically cut the threads at the end of the stitching. This is called “programmed thread cutting”. If programmed thread cutting is set, automatic reverse/reinforcement stitching is also set.



#### 1 Turn on the machine.

#### 2 Select a stitch.

- For details on selecting a stitch, refer to “Selecting a stitch pattern” on page B-32.

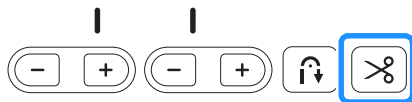
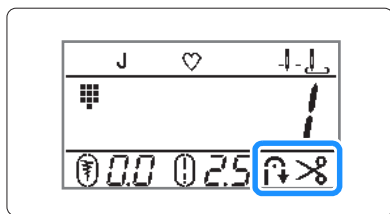
#### 3 Press .



→  and  appear in the LCD, and the machine is set for programmed thread cutting and automatic reverse/reinforcement stitching.

- To turn programmed thread cutting off, press .

#### 4 Set the fabric in place, and press the “Start/Stop” button once.



→ Stitching will begin after reverse stitches or reinforcement stitches are sewn.

#### 5 Once you have reached the end of the stitching, press (Reverse stitch button) or (Reinforcement stitch button) once.



If stitching, such as buttonholes and bar tacking, that includes reinforcement stitching has been selected, this operation is unnecessary.

→ After the reverse stitching or reinforcement stitching has been done, the machine stops, and the thread is cut.



- ① The point where the “Start/Stop” button was pressed.
- ② The point where  (Reverse stitch button) or  (Reinforcement stitch button) was pressed.
- ③ The thread is cut here.

#### Memo

- Programmed thread cutting will not be performed if the “Start/Stop” button is pressed while sewing. Press  (Reverse stitch button) or  (Reinforcement stitch button) at the end of the stitching.
- If the power is turned off, programmed thread cutting will be turned off.



## Adjusting the presser foot pressure

You can adjust the presser foot pressure (the amount of pressure applied to the fabric by the presser foot) with the presser foot pressure dial.

- 1 Lower the presser foot lever to lower the presser foot.

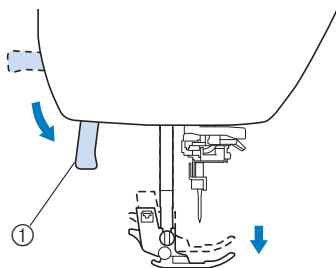

① Presser foot lever

- 2 Turn the presser foot pressure dial at the back of the machine to adjust the pressure of the presser foot.

The presser foot pressure can be set to one of four levels (between 1 and 4). The higher the number, the greater the pressure will be.

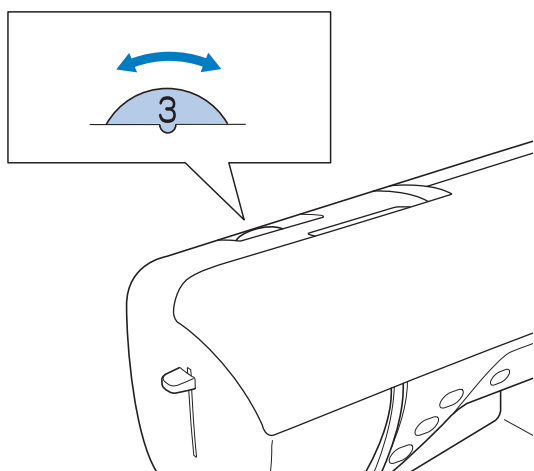

- 3 When you are finished sewing, reset the dial to 3 (standard).

## Stitch Setting Chart

Applications, stitch lengths and widths and whether the twin needle can be used are listed for utility stitches in the following table.

\*1 Patterns printed on the numeric keys on the machine can be selected directly. For details, refer to “Preset utility stitches” on page B-46.

\*2 For free motion quilting, use free motion open toe quilting foot “O” (sold separately with some models).

\*3 When automatic reverse/reinforcement stitching has been set, the stitch will begin with reinforcement stitch.







If reinforcement priority has been set to “ON”, the machine will sew reinforcement stitches at the end of stitching and then stop.



### Note

- The walking foot can only be used with straight or zigzag stitch patterns. Do not sew reverse stitches with the walking foot.

Stitch	Stitch number	Stitch name	Presser foot	Applications	Stitch width [mm (inch)]		Stitch length [mm (inch)]		Twin needle	Reverse button
					Auto.	Manual	Auto.	Manual		
	01* <sup>1</sup>	<b>Straight stitch (Left)</b>	J* <sup>2</sup>	General sewing, gather, pintuck, etc.	<b>0.0 (0)</b> 0.0 - 7.0 (0 - 1/4)	<b>2.5 (3/32)</b> 0.2 - 5.0 (1/64 - 3/16)	OK (J)	Reverse		
	02* <sup>1</sup>	<b>Straight stitch (Left)</b>	J* <sup>2</sup>	General sewing, gather, pintuck, etc.	<b>0.0 (0)</b> 0.0 - 7.0 (0 - 1/4)	<b>2.5 (3/32)</b> 0.2 - 5.0 (1/64 - 3/16)	OK (J)	Reverse* <sup>3</sup>		
	03* <sup>1</sup>	<b>Straight stitch (Middle)</b>	J* <sup>2</sup>	General sewing, gather, pintuck, etc.	<b>3.5 (1/8)</b> 0.0 - 7.0 (0 - 1/4)	<b>2.5 (3/32)</b> 0.2 - 5.0 (1/64 - 3/16)	OK (J)	Reverse		
	04* <sup>1</sup>	<b>Straight stitch (Middle)</b>	J* <sup>2</sup>	General sewing, gather, pintuck, etc.	<b>3.5 (1/8)</b> 0.0 - 7.0 (0 - 1/4)	<b>2.5 (3/32)</b> 0.2 - 5.0 (1/64 - 3/16)	OK (J)	Reverse* <sup>3</sup>		
	05* <sup>1</sup>	<b>Triple stretch stitch</b>	J* <sup>2</sup>	General sewing for reinforcement and decorative topstitching	<b>0.0 (0)</b> 0.0 - 7.0 (0 - 1/4)	<b>2.5 (3/32)</b> 0.4 - 5.0 (1/64 - 3/16)	OK (J)	Reinforcement		
	06* <sup>1</sup>	<b>Stem stitch</b>	J* <sup>2</sup>	Reinforced stitching, sewing and decorative applications	<b>1.0 (1/16)</b> 0.0 - 7.0 (0 - 1/4)	<b>2.5 (3/32)</b> 0.4 - 5.0 (1/64 - 3/16)	OK (J)	Reinforcement		
	07	<b>Basting stitch</b>	J* <sup>2</sup>	Basting	<b>0.0 (0)</b> 0.0 - 7.0 (0 - 1/4)	-	NO	Reinforcement		
	08* <sup>1</sup>	<b>Zigzag stitch</b>	J* <sup>2</sup>	For overcasting, mending.	<b>3.5 (1/8)</b> 0.0 - 7.0 (0 - 1/4)	<b>1.4 (1/16)</b> 0.0 - 5.0 (0 - 3/16)	OK (J)	Reverse		
	09* <sup>1</sup>	<b>Zigzag stitch</b>	J* <sup>2</sup>	For overcasting, mending.	<b>3.5 (1/8)</b> 0.0 - 7.0 (0 - 1/4)	<b>1.4 (1/16)</b> 0.0 - 5.0 (0 - 3/16)	OK (J)	Reverse* <sup>3</sup>		
	10	<b>Zigzag stitch (Right)</b>	J* <sup>2</sup>	Start from right needle position, zigzag sews to left.	<b>3.5 (1/8)</b> 2.5 - 5.0 (3/32 - 3/16)	<b>1.4 (1/16)</b> 0.3 - 5.0 (1/64 - 3/16)	OK (J)	Reverse* <sup>3</sup>		
	11	<b>2 steps elastic zigzag stitch</b>	J* <sup>2</sup>	Overcasting (medium weight and stretch fabrics), tape and elastic	<b>5.0 (3/16)</b> 0.0 - 7.0 (0 - 1/4)	<b>1.0 (1/16)</b> 0.2 - 5.0 (1/64 - 3/16)	OK (J)	Reverse* <sup>3</sup>		
	12* <sup>1</sup>	<b>3 steps elastic zigzag stitch</b>	J* <sup>2</sup>	Overcasting (medium, heavyweight and stretch fabrics), tape and elastic	<b>5.0 (3/16)</b> 0.0 - 7.0 (0 - 1/4)	<b>1.0 (1/16)</b> 0.2 - 5.0 (1/64 - 3/16)	OK (J)	Reverse* <sup>3</sup>		
	13* <sup>1</sup>	<b>Overcasting stitch</b>	G	Reinforcing of light and medium weight fabrics	<b>3.5 (1/8)</b> 2.5 - 5.0 (3/32 - 3/16)	<b>2.0 (1/16)</b> 0.4 - 5.0 (1/64 - 3/16)	NO	Reinforcement		
	14	<b>Overcasting stitch</b>	G	Reinforcing of heavyweight fabric	<b>5.0 (3/16)</b> 2.5 - 5.0 (3/32 - 3/16)	<b>2.5 (3/32)</b> 0.4 - 5.0 (1/64 - 3/16)	NO	Reinforcement		

Stitch		Stitch name	Presser foot	Applications	Stitch width [mm (inch)]	Stitch length [mm (inch)]	Twin needle	Reverse button
	Stitch number				Auto. Manual	Auto. Manual		
	15	<b>Overcasting stitch</b>	G	Reinforcing of medium, heavyweight and easily friable fabrics or decorative stitching.	<b>5.0 (3/16)</b> 3.5 - 5.0 (1/8 - 3/16)	<b>2.5 (3/32)</b> 0.4 - 5.0 (1/64 - 3/16)	NO	Reinforcement
	16	<b>Overcasting stitch</b>	J*2	Reinforced seaming of stretch fabric	<b>5.0 (3/16)</b> 0.0 - 7.0 (0 - 1/4)	<b>2.5 (3/32)</b> 0.4 - 5.0 (1/64 - 3/16)	OK (J)	Reinforcement
	17	<b>Overcasting stitch</b>	J*2	Reinforcing of medium stretch fabric and heavyweight fabric, decorative stitching	<b>5.0 (3/16)</b> 0.0 - 7.0 (0 - 1/4)	<b>2.5 (3/32)</b> 0.4 - 5.0 (1/64 - 3/16)	OK (J)	Reinforcement
	18	<b>Overcasting stitch</b>	J*2	Reinforcement of stretch fabric or decorative stitching	<b>4.0 (3/16)</b> 0.0 - 7.0 (0 - 1/4)	<b>4.0 (3/16)</b> 0.4 - 5.0 (1/64 - 3/16)	OK (J)	Reinforcement
	19	<b>Overcasting stitch</b>	J*2	Stretch knit seam	<b>5.0 (3/16)</b> 0.0 - 7.0 (0 - 1/4)	<b>4.0 (3/16)</b> 0.4 - 5.0 (1/64 - 3/16)	NO	Reinforcement
	20	<b>With side cutter</b>	S	Straight stitch while cutting fabrics	<b>0.0 (0)</b> 0.0 - 2.5 (0 - 3/32)	<b>2.5 (3/32)</b> 0.2 - 5.0 (1/64 - 3/16)	NO	Reinforcement
	21	<b>With side cutter</b>	S	Zigzag stitch while cutting fabrics	<b>3.5 (1/8)</b> 3.5 - 5.0 (1/8 - 3/16)	<b>1.4 (1/16)</b> 0.0 - 5.0 (0 - 3/16)	NO	Reinforcement
	22	<b>With side cutter</b>	S	Overcasting stitch while cutting fabrics	<b>3.5 (1/8)</b> 3.5 - 5.0 (1/8 - 3/16)	<b>2.0 (1/16)</b> 0.4 - 5.0 (1/64 - 3/16)	NO	Reinforcement
	23	<b>With side cutter</b>	S	Overcasting stitch while cutting fabrics	<b>5.0 (3/16)</b> 3.5 - 5.0 (1/8 - 3/16)	<b>2.5 (3/32)</b> 0.4 - 5.0 (1/64 - 3/16)	NO	Reinforcement
	24	<b>With side cutter</b>	S	Overcasting stitch while cutting fabrics	<b>5.0 (3/16)</b> 3.5 - 5.0 (1/8 - 3/16)	<b>2.5 (3/32)</b> 0.4 - 5.0 (1/64 - 3/16)	NO	Reinforcement
	25	<b>Piecing stitch (Right)</b>	J*2	Piecework/patchwork 6.5 mm (approx. 1/4 inch) right seam allowance	<b>5.5 (7/32)</b> 0.0 - 7.0 (0 - 1/4)	<b>2.0 (1/16)</b> 0.2 - 5.0 (1/64 - 3/16)	NO	Reverse* <sup>3</sup>
	26	<b>Piecing stitch (Middle)</b>	J*2	Piecework/patchwork	—	<b>2.0 (1/16)</b> 0.2 - 5.0 (1/64 - 3/16)	NO	Reverse* <sup>3</sup>
	27	<b>Hand-look quilting stitch</b>	J*2	Quilting stitch made to look like hand quilting when using transparent nylon thread for the upper thread and a thread color matching the quilt for the bobbin thread. Sew with a tight thread tension so that the bobbin thread is visible from the right side of the fabric. Use a needle between 90/14 and 100/16.	<b>0.0 (0)</b> 0.0 - 7.0 (0 - 1/4)	<b>2.5 (3/32)</b> 0.4 - 5.0 (1/64 - 3/16)	NO	Reinforcement
	28	<b>Quilting appliqué zigzag stitch</b>	J*2	Zigzag stitch for quilting and sewing on appliqué quilt pieces	<b>3.5 (1/8)</b> 0.0 - 7.0 (0 - 1/4)	<b>1.4 (1/16)</b> 0.0 - 5.0 (0 - 3/16)	NO	Reverse* <sup>3</sup>
	29	<b>Quilting appliqué stitch</b>	J*2	Quilting stitch for invisible appliqué or attaching binding	<b>1.5 (1/16)</b> 0.0 - 3.5 (0 - 1/8)	<b>1.8 (1/16)</b> 0.4 - 5.0 (1/64 - 3/16)	NO	Reinforcement
	30	<b>Quilting stippling stitch</b>	J*2	Background quilting	<b>7.0 (1/4)</b> 0.0 - 7.0 (0 - 1/4)	<b>1.6 (1/16)</b> 0.4 - 5.0 (1/64 - 3/16)	NO	Reinforcement
	31	<b>Blind hem stitch</b>	R	Hemming woven fabrics	<b>00</b> -3← - →3	<b>2.0 (1/16)</b> 0.4 - 5.0 (1/64 - 3/16)	NO	Reinforcement
	32	<b>Blind hem stretch stitch</b>	R	Hemming stretch fabric	<b>00</b> -3← - →3	<b>2.0 (1/16)</b> 0.4 - 5.0 (1/64 - 3/16)	NO	Reinforcement
	33	<b>Blanket stitch</b>	J	Appliqués, decorative blanket stitch	<b>3.5 (1/8)</b> 0.0 - 7.0 (0 - 1/4)	<b>2.5 (3/32)</b> 0.4 - 5.0 (1/64 - 3/16)	OK (J)	Reinforcement













Stitch		Stitch name	Presser foot	Applications	Stitch width [mm (inch)]	Stitch length [mm (inch)]	Twin needle	Reverse button
	Stitch number				Auto. Manual	Auto. Manual		
	34	Shell tuck edge stitch	J*2	Shell tuck edge finish on fabrics	4.0 (3/16) 0.0 - 7.0 (0 - 1/4)	2.5 (3/32) 0.2 - 5.0 (1/64 - 3/16)	OK (J)	Reinforcement
	35	Satin scallop stitch	N*2	Decorating collar of blouse, edge of handkerchief	5.0 (3/16) 0.0 - 7.0 (0 - 1/4)	0.5 (1/32) 0.1 - 5.0 (1/64 - 3/16)	OK (J)	Reinforcement
	36	Patchwork join stitch	J*2	Patchwork stitches, decorative stitching	4.0 (3/16) 0.0 - 7.0 (0 - 1/4)	1.2 (1/16) 0.2 - 5.0 (1/64 - 3/16)	OK (J)	Reinforcement
	37	Patchwork double overlock stitch	J*2	Patchwork stitches, decorative stitching	5.0 (3/16) 0.0 - 7.0 (0 - 1/4)	2.5 (3/32) 0.4 - 5.0 (1/64 - 3/16)	OK (J)	Reinforcement
	38	Couching stitch	J*2	Decorative stitching, attaching cord and couching	5.0 (3/16) 0.0 - 7.0 (0 - 1/4)	1.2 (1/16) 0.2 - 5.0 (1/64 - 3/16)	OK (J)	Reinforcement
	39	Smocking stitch	J*2	Smocking, decorative stitching	5.0 (3/16) 0.0 - 7.0 (0 - 1/4)	1.6 (1/16) 0.4 - 5.0 (1/64 - 3/16)	OK (J)	Reinforcement
	40	Feather stitch	J*2	Fagoting, decorative stitching	5.0 (3/16) 0.0 - 7.0 (0 - 1/4)	2.5 (3/32) 0.4 - 5.0 (1/64 - 3/16)	OK (J)	Reinforcement
	41	Fagoting cross stitch	J*2	Fagoting, bridging and decorative stitching	5.0 (3/16) 0.0 - 7.0 (0 - 1/4)	2.5 (3/32) 0.4 - 5.0 (1/64 - 3/16)	OK (J)	Reinforcement
	42	Tape attaching stitch	J*2	Attaching tape to seam in stretch fabric	4.0 (3/16) 0.0 - 7.0 (0 - 1/4)	1.0 (1/16) 0.2 - 5.0 (1/64 - 3/16)	OK (J)	Reinforcement
	43	Ladder stitch	J*2	Decorative stitching	4.0 (3/16) 0.0 - 7.0 (0 - 1/4)	3.0 (1/8) 0.4 - 5.0 (1/64 - 3/16)	NO	Reinforcement
	44	Rick-rack stitch	J*2	Decorative top stitching	4.0 (3/16) 0.0 - 7.0 (0 - 1/4)	2.5 (3/32) 0.4 - 5.0 (1/64 - 3/16)	OK (J)	Reinforcement
	45	Decorative stitch	J*2	Decorative stitching	5.5 (7/32) 0.0 - 7.0 (0 - 1/4)	1.6 (1/16) 0.4 - 5.0 (1/64 - 3/16)	OK (J)	Reinforcement
	46	Serpentine stitch	N*2	Decorative stitching and attaching elastic	5.0 (3/16) 0.0 - 7.0 (0 - 1/4)	1.0 (1/16) 0.2 - 5.0 (1/64 - 3/16)	OK (J)	Reinforcement
	47	Hemstitching zigzag	N*2	Decorative hems, top stitching	6.0 (15/64) 0.0 - 7.0 (0 - 1/4)	3.0 (1/8) 0.4 - 5.0 (1/64 - 3/16)	OK (J)	Reinforcement
	48	Hemstitching	N*2	Decorative hems, lace attaching pin stitch	3.5 (1/8) 0.0 - 7.0 (0 - 1/4)	2.5 (3/32) 0.4 - 5.0 (1/64 - 3/16)	NO	Reinforcement
	49	Hemstitching	N*2	Decorative hems	3.0 (1/8) 0.0 - 7.0 (0 - 1/4)	3.5 (1/8) 0.4 - 5.0 (1/64 - 3/16)	NO	Reinforcement
	50	Hemstitching	N*2	Decorative hems daisy stitch	6.0 (15/64) 0.0 - 7.0 (0 - 1/4)	3.0 (1/8) 0.4 - 5.0 (1/64 - 3/16)	NO	Reinforcement
	51	Hemstitching	N*2	Heirloom, decorative hems	5.0 (3/16) 0.0 - 7.0 (0 - 1/4)	3.5 (1/8) 0.4 - 5.0 (1/64 - 3/16)	NO	Reinforcement
	52	Hemstitching	N*2	Heirloom, decorative hems	5.0 (3/16) 0.0 - 7.0 (0 - 1/4)	4.0 (3/16) 0.4 - 5.0 (1/64 - 3/16)	OK (J)	Reinforcement
	53	Hemstitching	N*2	Heirloom, decorative hems	6.0 (15/64) 0.0 - 7.0 (0 - 1/4)	1.6 (1/16) 0.4 - 5.0 (1/64 - 3/16)	OK (J)	Reinforcement
	54	Hemstitching	N*2	Heirloom, decorative hems	6.0 (15/64) 0.0 - 7.0 (0 - 1/4)	3.0 (1/8) 0.4 - 5.0 (1/64 - 3/16)	NO	Reinforcement

Stitch		Stitch name	Presser foot	Applications	Stitch width [mm (inch)]	Stitch length [mm (inch)]	Twin needle	Reverse button
	Stitch number				Auto. Manual	Auto. Manual		
	55	<b>Hemstitching</b>	N*2	Heirloom, decorative hems	<b>4.0 (3/16)</b> 0.0 - 7.0 (0 - 1/4)	<b>2.5 (3/32)</b> 0.4 - 5.0 (1/64 - 3/16)	NO	Reinforcement
	56	<b>Hemstitching</b>	N*2	Heirloom, decorative hems	<b>5.0 (3/16)</b> 0.0 - 7.0 (0 - 1/4)	<b>2.0 (1/16)</b> 0.4 - 5.0 (1/64 - 3/16)	OK (J)	Reinforcement
	57	<b>Hemstitching</b>	N*2	Decorative hems and bridging stitch	<b>6.0 (15/64)</b> 0.0 - 7.0 (0 - 1/4)	<b>2.0 (1/16)</b> 0.4 - 5.0 (1/64 - 3/16)	OK (J)	Reinforcement
	58	<b>Narrow rounded buttonhole stitch</b>	A	Buttonhole on light to medium weight fabrics	<b>5.0 (3/16)</b> 3.0 - 5.0 (1/8 - 3/16)	<b>0.4 (1/64)</b> 0.2 - 1.0 (1/64 - 1/16)	NO	Automatic reinforcement
	59	<b>Narrow squared buttonhole stitch</b>	A	Buttonholes for light to medium weight fabrics	<b>5.0 (3/16)</b> 3.0 - 5.0 (1/8 - 3/16)	<b>0.4 (1/64)</b> 0.2 - 1.0 (1/64 - 1/16)	NO	Automatic reinforcement
	60	<b>Stretch buttonhole stitch</b>	A	Buttonholes for stretch or woven fabrics	<b>6.0 (15/64)</b> 3.0 - 6.0 (1/8 - 15/64)	<b>1.0 (1/16)</b> 0.5 - 2.0 (1/32 - 1/16)	NO	Automatic reinforcement
	61	<b>Heirloom buttonhole stitch</b>	A	Buttonholes for heirloom and stretch fabrics	<b>6.0 (15/64)</b> 3.0 - 6.0 (1/8 - 15/64)	<b>1.5 (1/16)</b> 1.0 - 3.0 (1/16 - 1/8)	NO	Automatic reinforcement
	62	<b>Bound buttonhole stitch</b>	A	The first step in making bound buttonholes	<b>5.0 (3/16)</b> 0.0 - 6.0 (0 - 15/64)	<b>2.0 (1/16)</b> 0.2 - 4.0 (1/64 - 3/16)	NO	Automatic reinforcement
	63	<b>Keyhole buttonhole stitch</b>	A	Buttonholes in heavyweight or thick fabrics for larger flat buttons	<b>7.0 (1/4)</b> 3.0 - 7.0 (1/8 - 1/4)	<b>0.5 (1/32)</b> 0.3 - 1.0 (1/64 - 1/16)	NO	Automatic reinforcement
	64	<b>Keyhole buttonhole stitch</b>	A	Buttonholes with vertical bar tack for reinforcement in heavyweight or thick fabrics	<b>7.0 (1/4)</b> 3.0 - 7.0 (1/8 - 1/4)	<b>0.5 (1/32)</b> 0.3 - 1.0 (1/64 - 1/16)	NO	Automatic reinforcement
	65	<b>Darning stitch</b>	A	Darning of medium weight fabric	<b>7.0 (1/4)</b> 2.5 - 7.0 (3/32 - 1/4)	<b>2.0 (1/16)</b> 0.4 - 2.5 (1/64 - 3/32)	NO	Automatic reinforcement
	66	<b>Darning stitch</b>	A	Darning of heavyweight fabric	<b>7.0 (1/4)</b> 2.5 - 7.0 (3/32 - 1/4)	<b>2.0 (1/16)</b> 0.4 - 2.5 (1/64 - 3/32)	NO	Automatic reinforcement
	67	<b>Bar tack stitch</b>	A	Reinforcement at opening of pocket, etc.	<b>2.0 (1/16)</b> 1.0 - 3.0 (1/16 - 1/8)	<b>0.4 (1/64)</b> 0.3 - 1.0 (1/64 - 1/16)	NO	Automatic reinforcement
	68	<b>Button sewing stitch</b>	M	Attaching buttons	<b>3.5 (1/8)</b> 2.5 - 4.5 (3/32 - 3/16)	—	NO	Reinforcement
	69	<b>Eyelet stitch</b>	N	For making eyelets, holes on belts, etc.	<b>7.0 (1/4)</b> 7.0 6.0 5.0 (1/4 15/64 3/16)	<b>7.0 (1/4)</b> 7.0 6.0 5.0 (1/4 15/64 3/16)	NO	Automatic reinforcement

■ **Preset utility stitches**

The most frequently used utility stitches have been assigned to the numeric keys.

These stitches can be selected simply by pressing the designated key while in the preset utility stitch mode.

 <b>Preset utility stitches</b>	<b>Stitch name</b>	 <b>Stitch number</b>
 1	<b>Straight stitch (Left)</b>	01
 2	<b>Straight stitch (Left)</b>	02
 3	<b>Straight stitch (Middle)</b>	03
 4	<b>Straight stitch (Middle)</b>	04
 5	<b>Zigzag stitch</b>	08
 6	<b>Zigzag stitch</b>	09
 7	<b>Triple stretch stitch</b>	05
 8	<b>Stem stitch</b>	06
 9	<b>Overcasting stitch</b>	13
 0	<b>3 steps elastic zigzag stitch</b>	12



# Sewing

This section describes procedures for using the various utility stitches as well as other functions. It provides details on basic sewing in addition to the more expressive features of the machine, such as sewing tubular pieces and buttonholes.  
Page number starts with "S" in this section.

**Chapter1 SEWING ATTRACTIVE FINISHES..... S-2**

---

**Chapter2 UTILITY STITCHES..... S-6**

---

## CAUTION

- Before replacing the presser foot, be sure to turn off the machine, otherwise injuries may occur if the "Start/Stop" button or any other button is pressed and the machine starts operating. For details on changing the presser foot, refer to "Replacing the Presser Foot" in the "Basic operations" section.

# Chapter 1 SEWING ATTRACTIVE FINISHES

## Sewing Tips

### Trial sewing

After you have set up the machine with the thread and needle appropriate for the type of fabric being sewn, the machine automatically sets the stitch length and width for the stitch that is selected. However, a trial piece of fabric should be sewn since, depending on the type of fabric and stitching being sewn, the desired results may not be achieved.

For the trial sewing, use a piece of fabric and thread that are the same as those used for your project, and check the thread tension and stitch length and width. Since the results differ depending on the type of stitching and the number of layers of fabric sewn, perform the trial sewing under the same conditions that will be used with your project.

### Changing the sewing direction

- 1 **When the stitching reaches a corner, stop the machine.**  
Leave the needle lowered (in the fabric). If the needle remains up when the machine stops sewing, press  (Needle position button) to lower the needle.
- 2 **Raise the presser foot lever, and then turn the fabric.**  
Turn the fabric using the needle as a pivot.

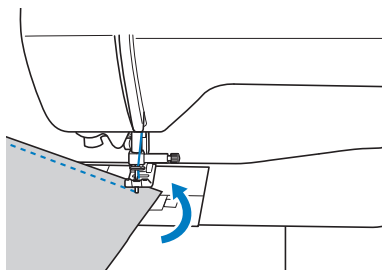

- 3 **Lower the presser foot lever and continue sewing.**

### Sewing curves

Sew slowly while slightly changing the sewing direction to sew around the curve. For details on sewing with an even seam allowance, refer to “Sewing an even seam allowance” on page S-3.

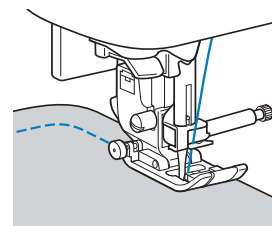

When sewing along a curve while using a zigzag stitch, select a shorter stitch length in order to obtain a finer stitch.

### Sewing cylindrical pieces

Removing the flat bed attachment allows for free-arm sewing, making it easier to sew cylindrical pieces such as sleeve cuffs and pant legs.

- 1 **Pull the flat bed attachment off to the left.**

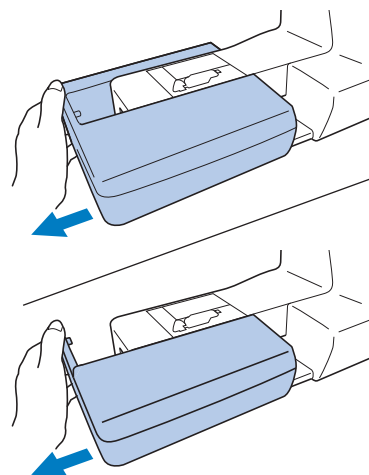

- 2 **Slide the part that you wish to sew onto the free arm, and then sew from the top.**

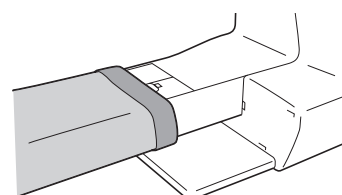



- 3 When you are finished with free arm sewing, install the flat bed attachment back in its original position.

## Sewing an even seam allowance

To sew an even seam, start sewing so that the seam allowance is to the right of the presser foot, and the edge of the fabric is aligned with either the right edge of the presser foot or a marking on the needle plate.

### Aligning the fabric with the presser foot

Sew while keeping the right edge of the presser foot a fixed distance from the edge of the fabric.

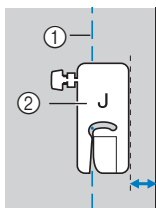

- ① Seam
- ② Presser foot

### Aligning the fabric with the stitch guide foot (sold separately with some models)

Sew while keeping the right edge of the fabric aligned with a desired position of markings on the stitch guide foot.

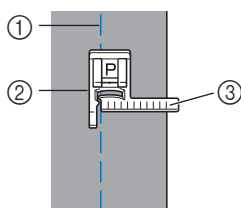

- ① Seam
- ② Stitch guide foot
- ③ Markings

### Aligning the fabric with a needle plate marking

The markings on the needle plate show the distance from the needle position of a seam sewn with the straight stitch (left needle position). Sew while keeping the edge of the fabric aligned with a marking on the needle plate. The distance between the markings in the upper scale is 1/8 inch (3 mm) and the distance between the markings in the grid is 5 mm (3/16 inch).

For stitches with a left needle position  
(Stitch width: 0.0 mm)

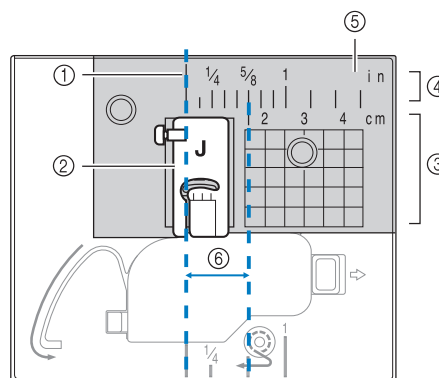

- ① Seam
- ② Presser foot
- ③ Centimeters
- ④ Inches
- ⑤ Needle plate
- ⑥ 1.6 cm (5/8 inch)

## Sewing Various Fabrics

### Sewing thick fabrics

#### ■ If the fabric does not fit under the presser foot

The presser foot lever can be raised to two different positions. If the fabric does not fit under the presser foot, for example, when sewing together thick fabrics, raise the presser foot lever to its highest position so that the fabric can be placed under the presser foot.

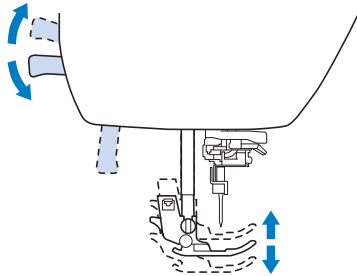

#### ■ If the fabric does not feed

When sewing thick fabric such as denim or quilting, the fabric may not feed at the start of sewing if the presser foot is not level, as shown below. In this case, use the presser foot locking pin (black button on the left side) of zigzag foot “J” so that the presser foot remains level while sewing, allowing the fabric to be fed smoothly.

If the presser foot misalignment is too large, place thick paper or fabric (with the same thickness as the fabric being sewn) under the heel of the presser foot to be able to start sewing smoothly.

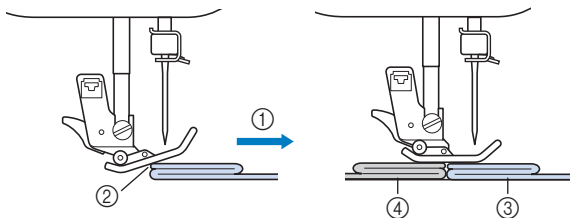

- ① Sewing direction
- ② Misalignment
- ③ Fabric being sewn
- ④ Fabric or thick paper

**1** Raise the presser foot lever.

**2** Align the beginning of stitching, and then position the fabric.

**3** While holding zigzag foot “J” level, push in and hold the presser foot locking pin (black button on the left side), and lower the presser foot lever.

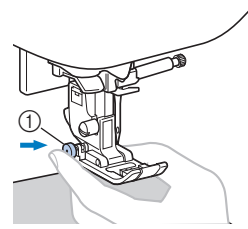

① Presser foot locking pin (black button)

**4** Release the presser foot locking pin (black button).

→ The presser foot remains level, allowing the fabric to be fed.

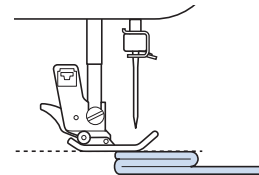

→ After the seam is sewn, the presser foot will return to its original angle.

#### Memo

- You may find adjusting the presser foot pressure dial helpful when sewing thick fabrics.

### CAUTION

- If fabric more than 6 mm (15/64 inch) thick is sewn or if the fabric is pushed with too much force, the needle may bend or break.

### Sewing thin fabrics

When sewing thin fabrics such as chiffon, the stitching may become misaligned or the fabric may not feed correctly. Move the needle (be sure to use a fine needle) to the furthest left or right hand position so that the fabric does not get pulled down into the feed dog area. If this occurs or there is shrinkage of the stitching, place non-woven water-soluble stabilizer under the fabric and sew them together. Using the straight stitch needle plate\* and straight stitch foot\* is also effective when sewing thin fabrics.

\* Sold separately with some models.

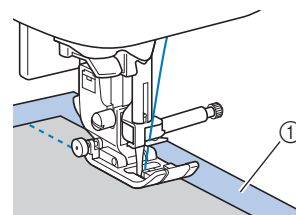

① Water-soluble stabilizer (non-woven)





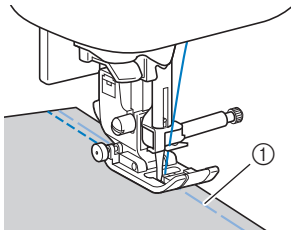

## Sewing stretch fabrics

First, baste the pieces of fabric together, and then sew without stretching the fabric. If the stitching is misaligned, place non-woven water-soluble stabilizer under the fabric and sew them together.



### ① Basting

For best results when sewing on knit fabrics use the stretch stitches. Also be sure to use a needle for knits (Ball point needle (gold colored)). The recommended stitches and their stitch numbers are indicated below.

Stitch					
	05*	06*	11	12*	42

\* Stitch patterns can be selected directly by pressing the numeric keys on the machine during preset utility stitch mode. Refer to "Basic operations" section.

## Sewing leathers or vinyl fabrics

When sewing fabrics that may stick to the presser foot, such as leather or vinyl fabrics, replace the presser foot with the walking foot\*, non stick foot\* or roller foot\*.

\* Sold separately with some models.

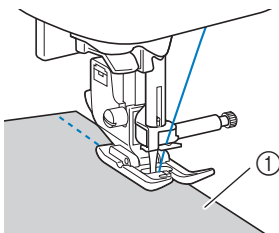

### ① Leather

If the leather or vinyl fabric sticks to the flat bed attachment, sew with copy paper or tracing paper placed on top of the flat bed attachment so the fabric moves smoothly.

If the paper is positioned so that it does not cover the needle plate, the paper will not be sewn together with the fabric.

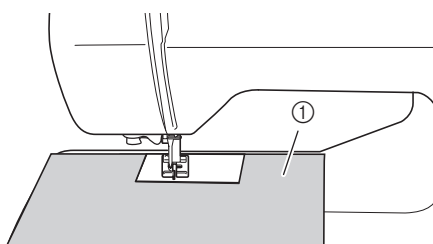

### ① Copy paper or tracing paper



### Note

- The walking foot can only be used with straight or zigzag stitch patterns. Do not sew reverse stitches with the walking foot. When sewing with the walking foot, sew at a speed between slow and medium.
- When using the walking foot, test sew on a scrap piece of leather or vinyl that is to be used in project to make sure foot does not leave any marks.

## Sewing hook-and-loop fastener tape

### ⚠ CAUTION

- Use only the adhesive-free hook-and-loop fastener tape which is designed for sewing. When the glue adheres to the needle or the bobbin hook race, it may cause malfunction.
- If the hook-and-loop fastener tape is sewn with the thin needle (65/9-75/11), the needle may bend or break.



### Note

- Before sewing, baste together the fabric and the hook-and-loop fastener tape.

Make sure that the needle passes through the hook-and-loop fastener tape by turning the handwheel and lower the needle into the hook-and-loop fastener tape before sewing. And then, sew the edge of the hook-and-loop fastener tape at a slow speed.

If the needle does not pass through the hook-and-loop fastener tape, replace the needle with the needle size for thicker fabrics. For details, refer to "Fabric/Thread/Needle Combinations" in the "Basic operations" section.

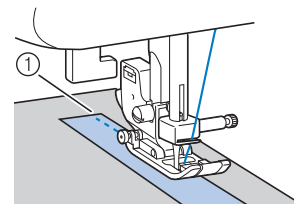







### ① Edge of the hook-and-loop fastener tape

# Chapter 2 UTILITY STITCHES

## Basic Stitching

Straight stitches are used for sewing plain seams.

Stitch name	Stitch	Stitch number	Presser foot
			
Basting stitch		07	J
Straight stitch (Left)		01*	
		02*	
Straight stitch (Middle)		03*	
Straight stitch (Middle)		04*	
Triple stretch stitch		05*	

\* Stitch patterns can be selected directly by pressing the numeric keys on the machine during preset utility stitch mode. Refer to “Basic operations” section.

## Basting

Sew basting with the preset stitch length of 5 mm (3/16 inch).

- 1 Attach zigzag foot “J”.

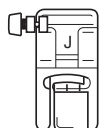

- 2 Select stitch .
- 3 Start sewing.



### Memo

- If the basting threads fall out of the fabric, pull up the bobbin thread before sewing, and then pull the upper thread and bobbin thread under the presser foot toward the back of the machine (refer to “Pulling up the bobbin thread” in the “Basic operations” section). Hold the upper thread and bobbin thread when beginning to sew, and when finished sewing, cut the threads leaving an excess amount of thread. Finally, hold the upper thread and bobbin thread at the beginning of the stitching while arranging the fabric.

## Basic stitching

- 1 Baste or pin together the fabric pieces.

- 2 Attach zigzag foot “J”.

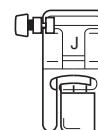

- 3 Select a stitch.
- 4 Lower the needle into the fabric at the beginning of the stitching.
- 5 Lower the presser foot lever, and then start sewing.
- 6 When sewing is finished, cut the thread.



## ■ Changing the needle position

The needle position used as the baseline is different for the straight stitch (left needle position) and the straight stitch (center needle position).

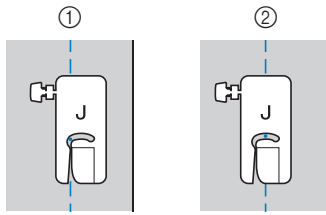

- ① Straight stitch (left needle position)
- ② Straight stitch (center needle position)

When the stitch width of the straight stitch (left needle position) is set to its standard setting (0.0 mm), the distance from the needle position to the right side of the presser foot is 12 mm (1/2 inch). If the stitch width is changed (between 0 and 7.0 mm (1/4 inch)), the needle position will also change. By changing the stitch width and sewing with the right side of the presser foot aligned with the edge of the fabric, a seam allowance can be sewn with a fixed width.

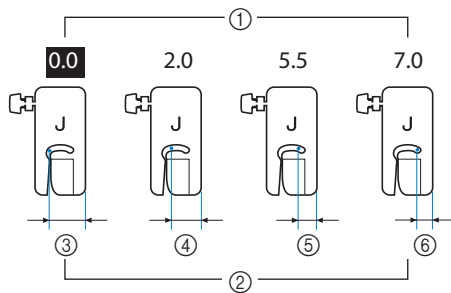

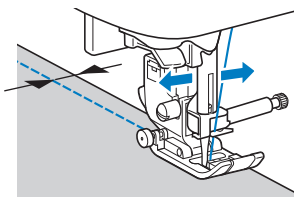

- ① Stitch width setting
- ② Distance from the needle position to the right side of the presser foot
- ③ 12.0 mm (1/2 inch)
- ④ 10.0 mm (3/8 inch)
- ⑤ 6.5 mm (1/4 inch)
- ⑥ 5.0 mm (3/16 inch)



- For details, refer to “Setting the stitch width” in the “Basic operations” section.

# Blind Hem Stitching

Secure the bottoms of skirts and pants with a blind hem.

Stitch name	Stitch	Stitch number	Presser foot
Blind hem stitch		31	R
Blind hem stretch stitch		32	

### Memo

- When the size of cylindrical pieces is too small to slide onto the arm or the length is too short, the fabric will not feed and desired results may not be achieved.

### 1 Turn the skirt or pants wrong side out.

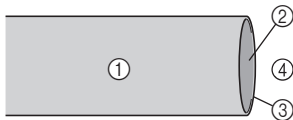

- ① Wrong side of fabric
- ② Right side of fabric
- ③ Edge of fabric
- ④ Bottom side

### 2 Fold the fabric along the desired edge of the hem, and press.

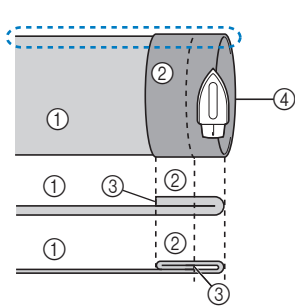

- ① Wrong side of fabric
- ② Right side of fabric
- ③ Edge of fabric
- ④ Desired edge of hem

<Thick fabric>

<Normal fabric>

<Seen from the side>

### 3 Use a chalk to mark on the fabric about 5 mm (3/16 inch) from the edge of the fabric, and then baste it.

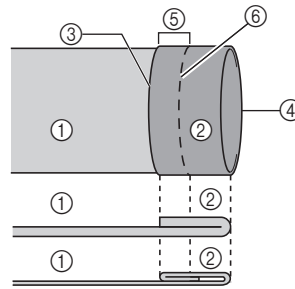

- ① Wrong side of fabric
- ② Right side of fabric
- ③ Edge of fabric
- ④ Desired edge of hem
- ⑤ 5 mm (3/16 inch)
- ⑥ Basting

<Thick fabric>

<Normal fabric>

<Seen from the side>

### 4 Fold back the fabric inside along the basting.

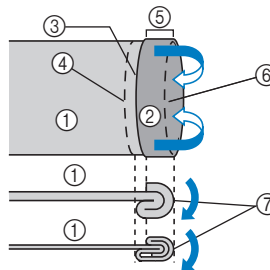

- ① Wrong side of fabric
- ② Right side of fabric
- ③ Edge of fabric
- ④ Desired edge of hem
- ⑤ 5 mm (3/16 inch)
- ⑥ Basting
- ⑦ Basting point

<Thick fabric>

<Normal fabric>

<Seen from the side>

### 5 Unfold the edge of fabric, and position the fabric with the wrong side facing up.

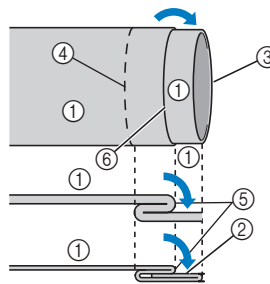

- ① Wrong side of fabric
- ② Right side of fabric
- ③ Edge of fabric
- ④ Desired edge of hem
- ⑤ Basting point
- ⑥ Basting

<Thick fabric>

<Normal fabric>

<Seen from the side>

### 6 Attach blind stitch foot "R".

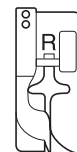

### 7 Select or .

### 8 Remove the flat bed attachment to use the free arm.

- 9 Slide the item that you wish to sew onto the free arm, make sure that the fabric feeds correctly, and then start sewing.

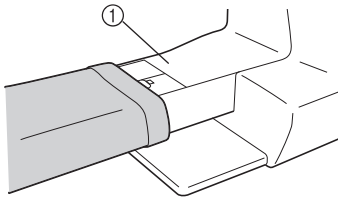

① Free arm

- 10 Position the fabric with the edge of the folded hem against the guide of the presser foot, and then lower the presser foot lever.

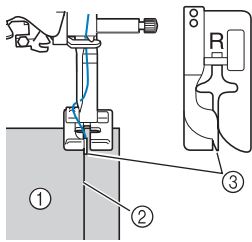

① Wrong side of fabric  
② Fold of hem  
③ Guide

- 11 Adjust the stitch width until the needle slightly catches the fold of the hem.

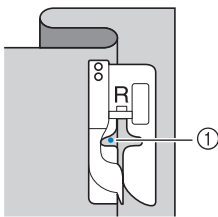

① Needle drop point  
When you change the needle drop point, raise the needle, and then change the stitch width.

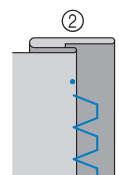
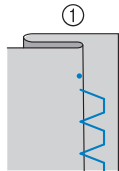
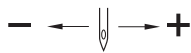

① Thick fabric  
② Normal fabric

### Memo

- Blind hem stitches cannot be sewn if the left needle drop point does not catch the fold. If the needle catches too much of the fold, the fabric cannot be unfolded and the seam appearing on the right side of the fabric will be very large, leaving an unattractive finish. If you experience either of these cases, perform the following instructions to solve the problem.

#### ■ If the needle catches too much of the hem fold

The needle is too far to the left.

Decrease the stitch width so that the needle slightly catches the fold of the hem.

#### □ Example: Thick fabric

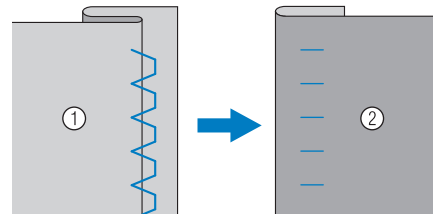

#### □ Example: Normal fabric

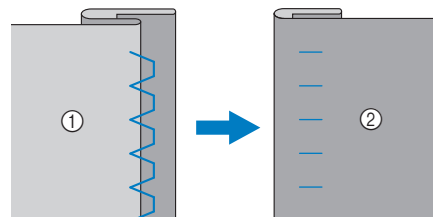

① Wrong side of fabric  
② Right side of fabric

■ **If the needle does not catch the hem fold**

The needle is too far to the right.  
Increase the stitch width so that the needle slightly catches the fold of the hem.

□ **Example:** Thick fabric

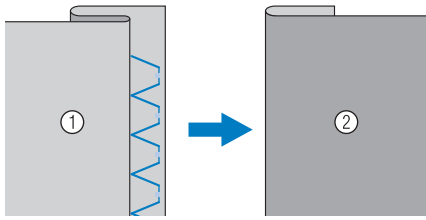

□ **Example:** Normal fabric

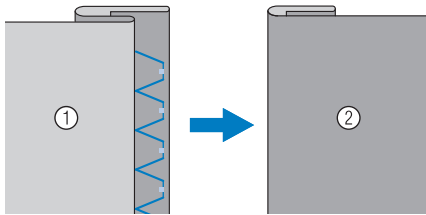

- ① Wrong side of fabric
- ② Right side of fabric

**12** Sew with the fold of the hem against the presser foot guide.

**13** Press the “Start/Stop” button to stop sewing when you are finished, and raise the presser foot and needle to remove the fabric by pulling it back.



**Note**

- Be sure to pull the fabric backward after finished sewing. If you pull the fabric toward side or forward, the presser foot may be damaged.

**14** Remove the basting stitching and reverse the fabric.

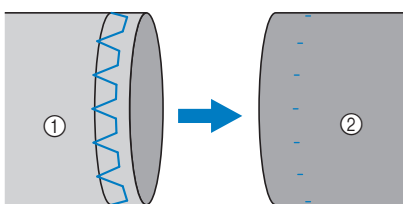





- ① Wrong side of fabric
- ② Right side of fabric



## Overcasting Stitches

Sew overcasting stitches along the edges of cut fabric to prevent them from fraying.

### Sewing overcasting stitches using overcasting foot "G"

Stitch name	Stitch	Stitch number	Presser foot
			
Overcasting stitch		13*	G
		14	
		15	

\* Stitch patterns can be selected directly by pressing the numeric keys on the machine during preset utility stitch mode. Refer to "Basic operations" section.

#### 1 Attach overcasting foot "G".



#### 2 Select a stitch.

#### 3 Position the fabric with the edge of the fabric against the guide of the presser foot, and then lower the presser foot lever.

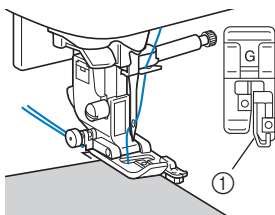

① Guide

#### 4 Sew with the edge of the fabric against the presser foot guide.

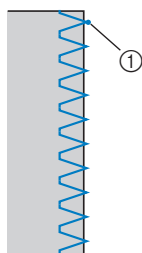

① Needle drop point

## ⚠ CAUTION



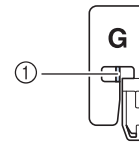





- After the stitch width is adjusted, rotate the handwheel toward you (counterclockwise). Check that the needle does not touch the presser foot. If the needle hits the presser foot, the needle may break and cause injury.



- ① The needle should not touch the center bar
- If the presser foot is raised to its highest level, the needle may strike the presser foot.

- #### 5
- Press the "Start/Stop" button to stop sewing when you are finished, and raise the presser foot and needle to remove the fabric by pulling it back.

## Sewing overcasting stitches using zigzag foot "J"

Stitch name	Stitch	Stitch number	Presser foot
Zigzag stitch		08*	J
Zigzag stitch (Right)		10	
2 steps elastic zigzag stitch		11	
3 steps elastic zigzag stitch		12*	
Overcasting stitch		16	
		17	
		18	
		19	

\* Stitch patterns can be selected directly by pressing the numeric keys on the machine during preset utility stitch mode. Refer to "Basic operations" section.

**1** Attach zigzag foot "J".

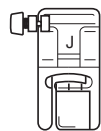

**2** Select a stitch.

**3** Sew along the edge of the fabric with the needle dropping off the edge at the right.

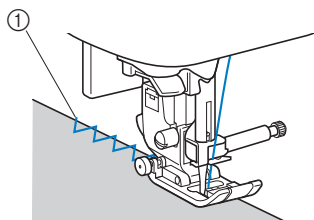

① Needle drop point

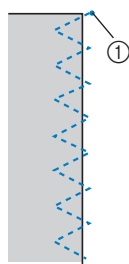

① Needle drop point





## Sewing overcasting stitches using the side cutter (sold separately with some models)

Using the side cutter, seam allowances can be finished while the edge of the fabric is cut off. Five utility stitches can be used to sew overcasting stitches with the side cutter.



**Note**

- Thread the needle manually when using the side cutter, or only attach the side cutter after threading the needle using the needle threader.

Stitch name	Stitch	Stitch number	Presser foot
With side cutter		20	S
		21	
		22	
		23	
		24	

Side cutter

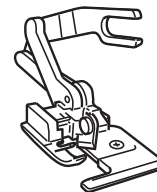

**1** Remove the presser foot.

**2** Hook the connecting fork of the side cutter onto the needle clamp screw.

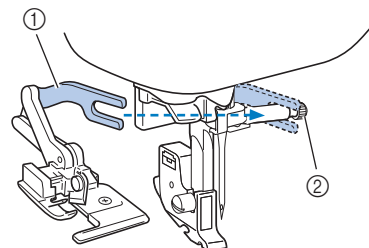

- ① Connecting fork
- ② Needle clamp screw

- 3** Position the side cutter so that side cutter pin is aligned with the notch in the presser foot holder, and then slowly lower the presser foot lever.

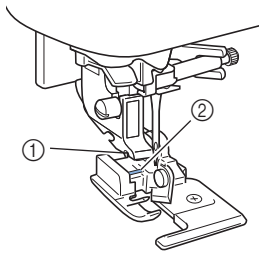

- ① Notch in presser foot holder  
② Pin

**Note**

- When it is hard to set under the presser foot holder, fit the pin on the side cutter into the notch of the presser foot holder raising up the presser foot lever higher.

- 4** Raise the presser foot lever to check that the side cutter is securely attached.

- 5** Pass the upper thread under the side cutter, and then pull it out toward the rear of the machine.

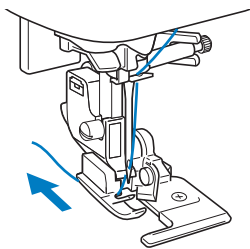

- 6** Select a stitch.

- 7** Make a cut of about 2 cm (3/4 inch) long in the fabric at the beginning of the stitching.

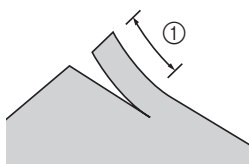

- ① 2 cm (3/4 inch)

- 8** Position the fabric so that the right side of the cut is on top of the guide plate and the left side of the cut is underneath the presser foot.

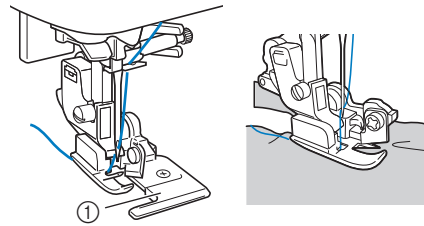

- ① Guide plate

- If the fabric is not positioned correctly, the fabric will not be cut.
- If the fabric is not feeding properly, gently guide fabric under foot the same as with regular sewing feet.

- 9** Lower the presser foot lever, and then start sewing.

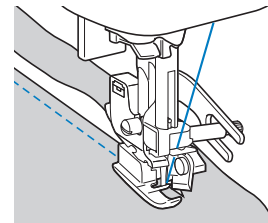

→ A seam allowance is cut while the stitching is sewn.

- If the stitching is sewn in a straight line the seam allowance will be about 5 mm (3/16 inch).

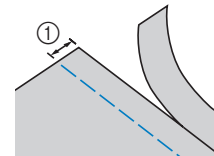









- ① 5 mm (3/16 inch)

**Memo**

- The side cutter can cut as much as one layer of 13-oz. denim.
- After using the side cutter, clean it by removing any lint or dust.
- If the side cutter can no longer cut fabric, use a piece of cloth to apply a small amount of oil to the cutting edge of the cutter.

## Buttonhole Stitching/Button Sewing

Stitch name	Stitch		Presser foot
		Stitch number	
Narrow rounded buttonhole stitch		58	A
Narrow squared buttonhole stitch		59	
Stretch buttonhole stitch		60	
Heirloom buttonhole stitch		61	
Bound buttonhole stitch		62	
Keyhole buttonhole stitch		63	
Keyhole buttonhole stitch		64	M
Button sewing stitch		68	

### Buttonhole sewing

The maximum buttonhole length is about 28 mm (1-1/8 inches) (diameter + thickness of the button).

Buttonholes are sewn from the front of the presser foot to the back, as shown below.

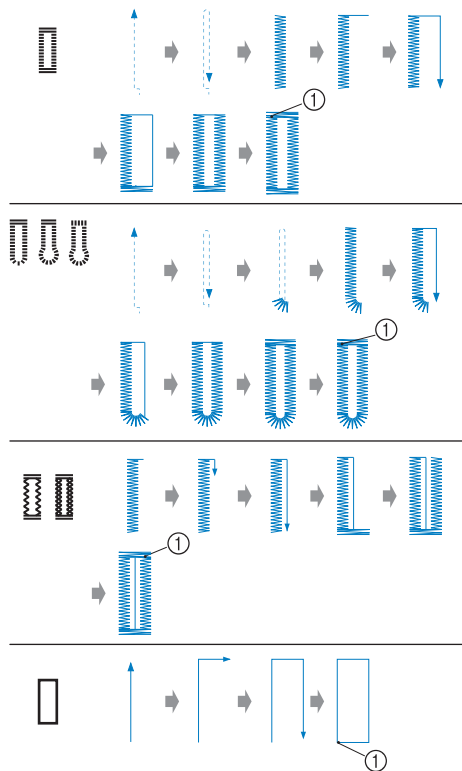

① Reinforcement stitching

The names of parts of buttonhole foot “A”, which is used to create buttonholes, are indicated below.

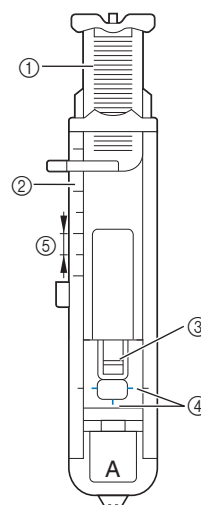

- ① Button guide plate
- ② Presser foot scale
- ③ Pin
- ④ Marks on buttonhole foot
- ⑤ 5 mm (3/16 inch)

- 1 Use chalk to mark on the fabric the position and length of the buttonhole.

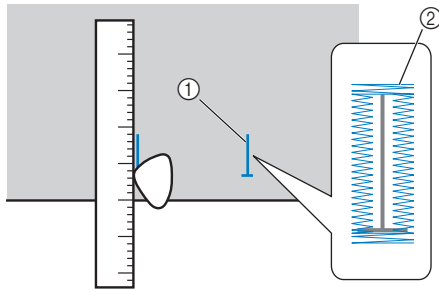

- ① Marks on fabric
- ② Buttonhole sewing

- 2 Pull out the button guide plate of buttonhole foot "A", and then insert the button that will be put through the buttonhole.

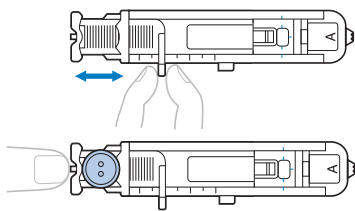

■ If the button does not fit in the button guide plate

Add together the diameter and thickness of the button, and then set the button guide plate to the calculated length. (The distance between the markings on the presser foot scale is 5 mm (3/16 inch).)

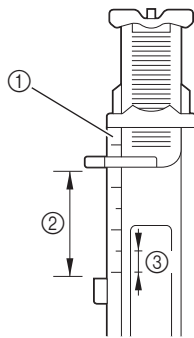

- ① Presser foot scale
- ② Length of buttonhole (diameter + thickness of button)
- ③ 5 mm (3/16 inch)

Example: For a button with a diameter of 15 mm (9/16 inch) and a thickness of 10 mm (3/8 inch), the button guide plate should be set to 25 mm (1 inch) on the scale.

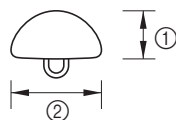

- ① 10 mm (3/8 inch)
- ② 15 mm (9/16 inch)

→ The size of the buttonhole is set.

- 3 Attach buttonhole foot "A".

Position the upper thread under the presser foot by guiding thread through the hole in the presser foot before attaching the buttonhole foot "A".

- 4 Select a stitch.

- 5 Position the fabric with the front end of the buttonhole mark aligned with the red marks on the sides of the buttonhole foot, and then lower the presser foot lever.

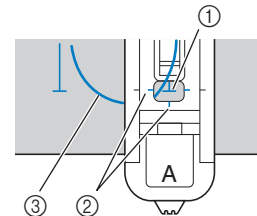

- ① Mark on fabric (front)
- ② Red marks on buttonhole foot
- ③ Upper thread

- When lowering the presser foot, do not push in the front of the presser foot.

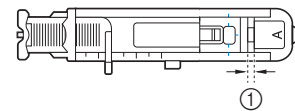
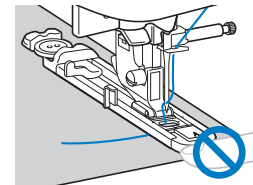

- ① Do not reduce the gap.

**6 Pull down the buttonhole lever as far as possible.**

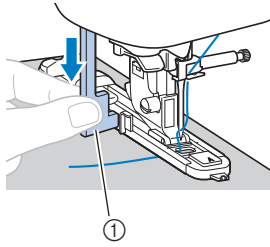

① Buttonhole lever  
The buttonhole lever is positioned behind the bracket on the buttonhole foot.

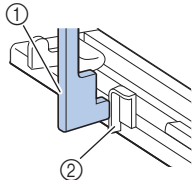

① Buttonhole lever  
② Bracket

**7 Gently hold the end of the upper thread in your left hand, and then start sewing.**

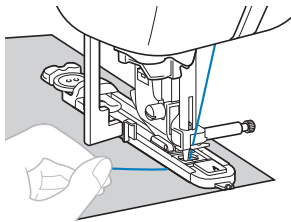

→ Once sewing is completed, the machine automatically sews reinforcement stitches, then stops.

**8 Cut the thread.**

**■ When using the cutter on the left side of the machine**

**Memo**

- When using the thread cutter on the left side of the machine or scissors to cut the threads, press  (Needle position button) to raise the needle, raise the presser foot, and then pull out the fabric before cutting the threads.

Cut the threads with the thread cutter by pulling fabric and threads toward the back of the machine; then up and over to the left side of the machine, placing threads on the top of the thread cutter and gently pulling down. The threads will then cut.

**■ When the thread cutter button is used (only on models with a thread cutter button)**

Press  once.  
Raise the presser foot, and then remove the fabric.

**Memo**

- If the automatic thread cutting setting was selected before sewing, the machine will automatically cut the threads at the end of the stitching. For details, refer to “Automatically cutting the thread (Only on models with automatic thread cutting key)” in the “Basic operations” section.

**9 Raise the buttonhole lever to its original position.**

**10 Insert a pin along the inside of one bar tack at the end of the buttonhole stitching to prevent the stitching from being cut.**

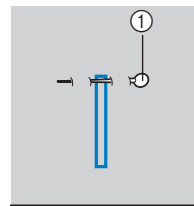

① Pin

**11 Use the seam ripper to cut towards the pin and open the buttonhole.**

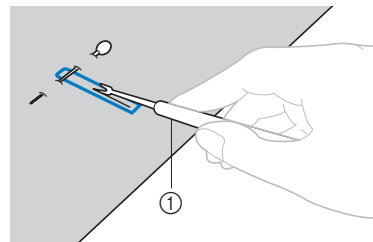

① Seam ripper

For keyhole buttonholes, use the eyelet punch to make a hole in the rounded end of the buttonhole, and then use the seam ripper to cut open the buttonhole.

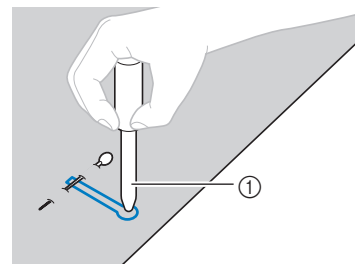

① Eyelet punch

- When using the eyelet punch, place thick paper or some other protective sheet under the fabric before punching the hole in the fabric.

**⚠ CAUTION**

- When opening the buttonhole with the seam ripper, do not place your hands in the cutting direction, otherwise injuries may result if the seam ripper slips.
- Do not use the seam ripper in any other way than how it is intended.

### ■ Changing the density of the stitching

Adjust the stitch length.

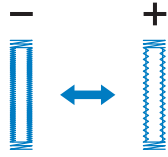

- For details, refer to “Setting the stitch length” in the “Basic operations” section.
- If the fabric does not feed (for example, if it is too thick), decrease the density of the stitching.

### ■ Changing the stitch width

Adjust the stitch width.

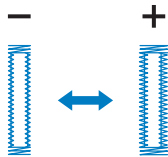

- For details, refer to “Setting the stitch width” in the “Basic operations” section.



#### Memo

- Before sewing buttonholes, check the stitch length and width by sewing a trial buttonhole on a scrap piece of fabric.

### ■ Sewing buttonholes on stretch fabrics

When sewing buttonholes on stretch fabrics, use a gimp thread.

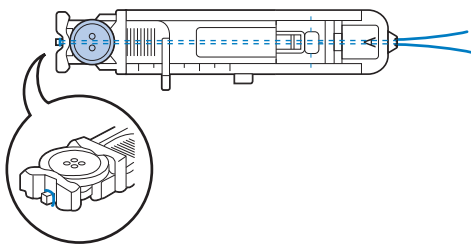

- 1 Hook the gimp thread onto the part of buttonhole foot “A” shown in the illustration.

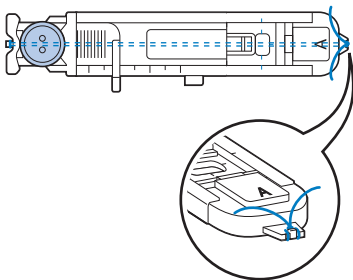

- 2 It fits into the grooves, and then loosely tie it.



- 3 Attach buttonhole foot “A”.

- 4 Select stitch  or .

- 5 Adjust the stitch width to the thickness of the gimp thread.

- 6 Lower the presser foot lever and the buttonhole lever, and then start sewing.

- 7 When sewing is finished, gently pull the gimp thread to remove any slack.

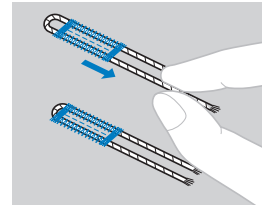

- 8 Use a handsewing needle to pull the gimp thread to the wrong side of the fabric, and then tie it.

### Button sewing

Buttons can be sewn on with the machine. Buttons with two or with four holes can be attached.

- 1 Measure the distance between the holes in the button to be attached.



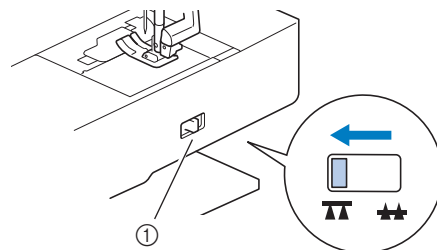

- 2 Raise the presser foot lever, and then slide the feed dog position switch, located at the rear of the machine on the base, to  (to the left as seen from the rear of the machine).

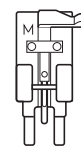

- ① Feed dog position switch (as seen from the rear of the machine)

- 3 Attach button fitting foot “M”.



**4** Select stitch .

- (Only on models with  (Automatic thread cutting key))  
Since the end of the thread will be tied off later, do not set the machine for programmed thread cutting.

**5** Adjust the stitch width so that it is the same as the distance between the holes in the button.

**6** Place the button in the position where it will be sewn, and lower the presser foot lever.

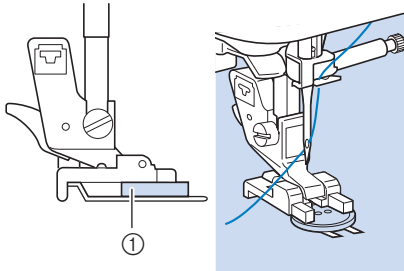

① Button

- When attaching four-hole buttons, first sew the two holes closest to you. Then, slide the button so that the needle goes into the two holes toward the rear of the machine, and then sew them in the same way.

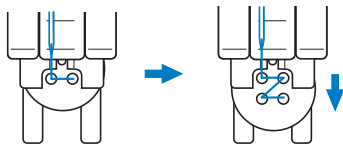

**7** Turn the handwheel toward you (counterclockwise) to check that the needle correctly goes into the two holes of the button.

If it seems as if the needle will hit the button, remeasure the distance between the holes in the button. Adjust the stitch width to the distance between the buttonholes.

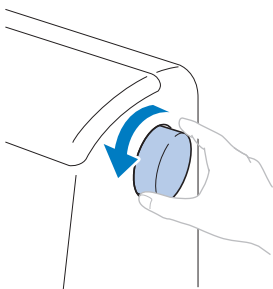

**⚠ CAUTION**

- When sewing, be sure that the needle does not touch the button, otherwise the needle may bend or break.

**8** Start sewing.

Set the sewing speed controller to the left (so that the speed will be slow).

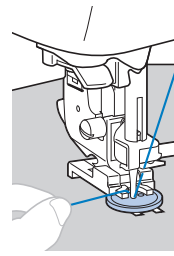



→ The machine automatically stops after sewing reinforcement stitches.

- (Only on models with  (Thread cutter button))  
Do not press .

**9** Use scissors to cut the upper thread and the bobbin thread at the beginning of the stitching.

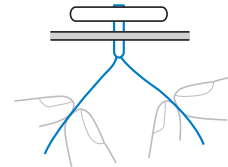
Pull the upper thread at the end of the stitching to the wrong side of the fabric, and then tie it with the bobbin thread.



**10** When you are finished attaching the button, slide the feed dog position switch, to  (to the right as seen from the rear of the machine) and turn the handwheel to raise the feed dogs.

 **Memo**

- The feed dogs come up when you start sewing again.



## ■ Attaching a shank to a button

To sew the button with a shank, attach the button with space between it and the fabric, and then wind the thread by hand. This attaches the button securely.

- 1 Place the button into button fitting foot "M", and then pull the shank lever toward you.

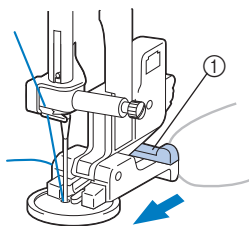

① Shank lever

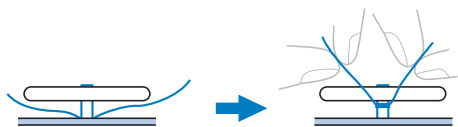

- 2 After sewing is finished, cut the upper thread with plenty of excess, wind it around the thread between the button and the fabric, and then tie it to the upper thread at the beginning of the stitching.

Tie together the ends of the bobbin thread at the end and at the beginning of the stitching at the wrong side of the fabric.



- 3 Cut off any excess thread.

## Zipper Insertion

Stitch name	Stitch		Presser foot
		Stitch number	
Straight stitch (Middle)		03*	J, I

\* Stitch patterns can be selected directly by pressing the numeric keys on the machine during preset utility stitch mode. Refer to "Basic operations" section.

### Inserting a centered zipper

Stitching is sewn on both pieces of fabric butted against each other.

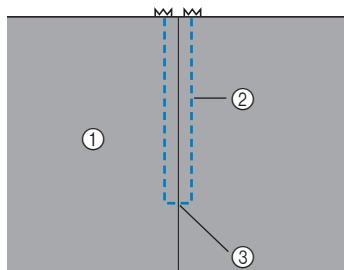

- ① Right side of fabric
- ② Stitching
- ③ End of zipper opening

**1** Attach zigzag foot "J".

**2** Sew straight stitches up to the zipper opening.

With the right sides of the fabric facing each other, sew reverse stitches after reaching the zipper opening.

**3** Using a basting stitch, continue sewing to the edge of the fabric.

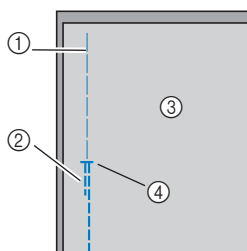

- ① Basting stitching
- ② Reverse stitches
- ③ Wrong side of fabric
- ④ End of zipper opening

**4** Press open the seam allowance from the wrong side of the fabric.

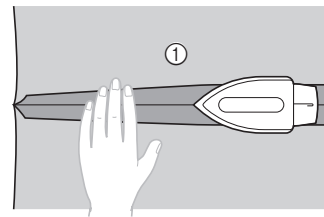

- ① Wrong side of fabric

**5** Align the seam with the center of the zipper, and then baste the zipper in place.

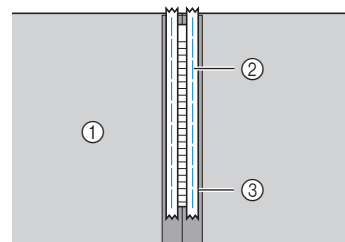

- ① Wrong side of fabric
- ② Basting stitching
- ③ Zipper

**6** Remove about 5 cm (2 inches) from the end of the basting on the outside.

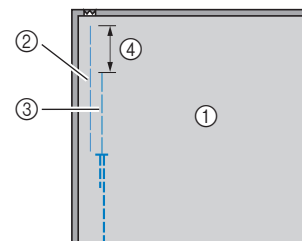

- ① Wrong side of fabric
- ② Zipper basting
- ③ Outside basting
- ④ 5 cm (2 inches)

**7** Attach the presser foot holder to the right pin of zipper foot "I".

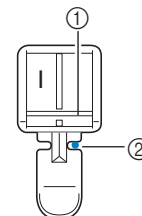

- ① Pin on the right side
- ② Needle drop point

8 Select stitch **CAUTION**

- When using zipper foot "I", be sure to select the straight stitch (center needle position), and slowly turn the handwheel toward you (counterclockwise) to check that the needle does not touch the presser foot. If a different stitch is selected or the needle hits the presser foot, the needle may bend or break.

## 9 Topstitch around the zipper.

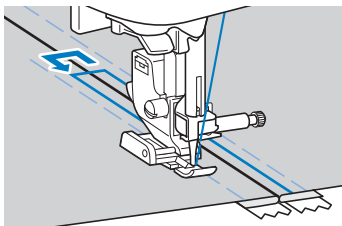
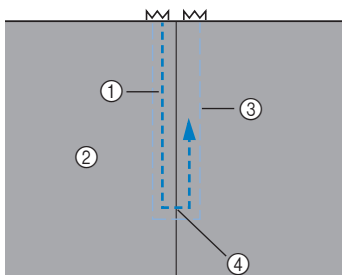

- Stitching
- Right side of fabric
- Basting stitching
- End of zipper opening

**CAUTION**

- When sewing, be sure that the needle does not touch the zipper, otherwise the needle may bend or break.

## 10 Remove the basting stitching.

**Inserting a side zipper**

Stitching is visible on only one piece of fabric. Use this type of zipper application for side openings and back openings.

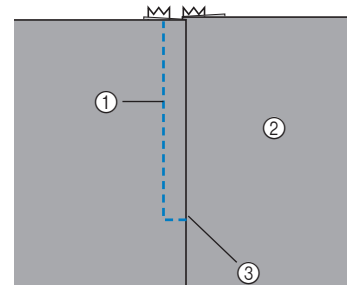

- Stitching
- Right side of fabric
- End of zipper opening

The following procedure will describe how to stitch on the left side, as shown in the illustration.

## 1 Attach zigzag foot "J".

## 2 Sew straight stitches up to the zipper opening.

With the right sides of the fabric facing each other, sew reverse stitches after reaching the zipper opening.

## 3 Using a basting stitch, continue sewing to the edge of the fabric.

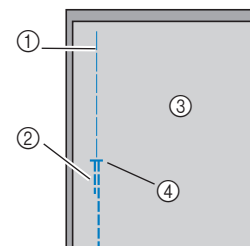

- Basting stitching
- Reverse stitches
- Wrong side of fabric
- End of zipper opening

## 4 Press open the seam allowance from the wrong side of the fabric.

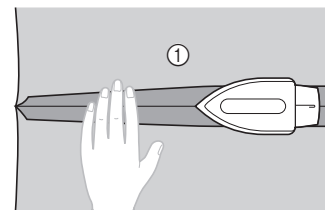

- Wrong side of fabric

- 5** Press the seam allowance so that the right side (the side that will not be stitched) has an extra 3 mm (1/8 inch).

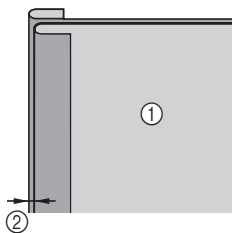

- ① Wrong side of fabric  
② 3 mm (1/8 inch)

- 6** Align the zipper teeth with the pressed edge of the fabric having the extra 3 mm (1/8 inch), and then baste or pin the zipper in place.

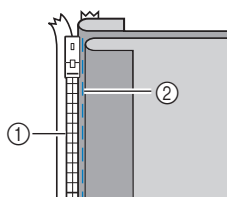

- ① Zipper teeth  
② Basting stitching

- 7** Attach the presser foot holder to the right pin of zipper foot "1".

If the stitching will be sewn on the right side, attach the presser foot holder to the left pin of the zipper foot.

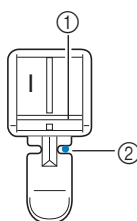

- ① Pin on the right side  
② Needle drop point

- 8** Select stitch .

## CAUTION

- When using zipper foot "1", be sure to select the straight stitch (center needle position), and slowly turn the handwheel toward you (counterclockwise) to check that the needle does not touch the presser foot. If a different stitch is selected or the needle hits the presser foot, the needle may bend or break.

- 9** Sew the zipper to the piece of fabric with the extra 3 mm (1/8 inch), starting from the base of the zipper.

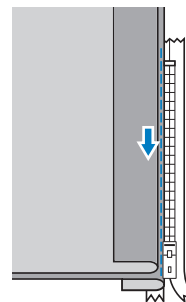

## CAUTION

- When sewing, be sure that the needle does not touch the zipper, otherwise the needle may bend or break.

- 10** When you are about 5 cm (2 inches) from the end of the zipper, stop the machine with the needle lowered (in the fabric), raise the presser foot lever.

- 11** Open the zipper and continue sewing.

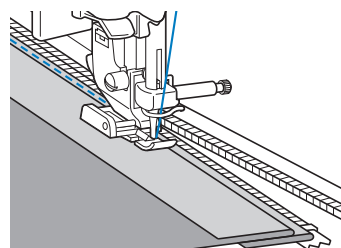

- 12** Close the zipper, turn over the fabric, and then baste the other side of the zipper to the fabric.

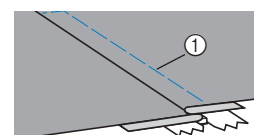
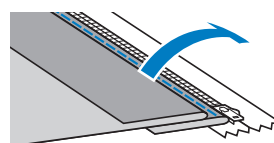

- ① Basting stitching

- 13** Attach the presser foot holder to the other pin of zipper foot "1".

If the presser foot holder was attached to the right pin in step **7**, change it to the left pin.

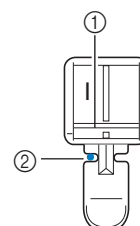

- ① Pin on the left side  
② Needle drop point

**14 Topstitch around the zipper.**

Sew reverse stitches at the end of the zipper opening and align the zipper teeth with the side of the presser foot.

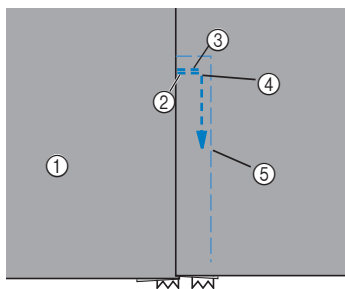

- ① Right side of fabric
- ② End of zipper opening
- ③ Reverse stitches
- ④ Beginning of stitching
- ⑤ Basting stitching

## ⚠ CAUTION

- When sewing, be sure that the needle does not touch the zipper, otherwise the needle may bend or break.

**15** When you are about 5 cm (2 inches) from the end of the zipper, stop the machine with the needle lowered (in the fabric), and then raise the presser foot lever.

**16** Remove the basting stitching, open the zipper, and then continue sewing.

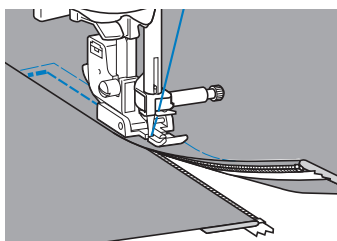

## Zipper/piping Insertion

A zipper and piping can be sewn in place.

Stitch name	Stitch	Stitch number	Presser foot
		Stitch number	
Straight stitch (Left)		01*	**

\* Stitch patterns can be selected directly by pressing the numeric keys on the machine during preset utility stitch mode. Refer to “Basic operations” section.

\*\* Adjustable zipper/piping foot (sold separately with some models)

### Inserting a centered zipper

1 Refer to step 1–6 of “Inserting a centered zipper” on page S-20.

2 Remove the presser foot and presser foot holder to attach the screw-on adjustable zipper/piping foot (sold separately with some models).

- For details on removing the presser foot holder, refer to “Removing and attaching the presser foot holder” in the “Basic operations” section.

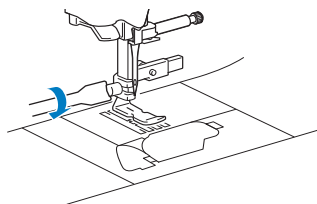

#### Note

- Make sure that the thread between the spool and the bobbin is pulled tight.

3 Select stitch .

4 Loosen the positioning screw on the back of the presser foot.

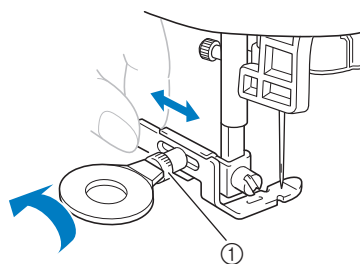

① Positioning screw

5 Slide the presser foot over to either the left or right feed dog.

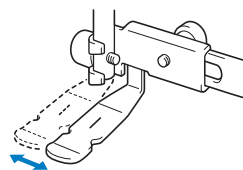

Left sewing position

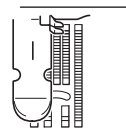

Right sewing position

6 Change the needle position so that the needle does not touch the presser foot.

For details, refer to “Setting the stitch width” in the “Basic operations” section.



① Needle drop point

### CAUTION

- After adjusting the needle position, slowly turn the handwheel toward you (counterclockwise) and check the needle does not touch the presser foot. If the needle hits the presser foot, the needle may bend or break.

7 Securely tighten the positioning screw using a screwdriver.

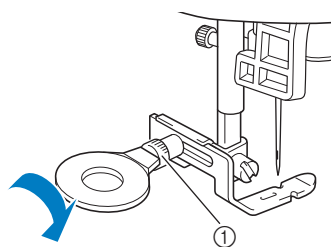

① Positioning screw

### 8 Topstitch around the zipper.

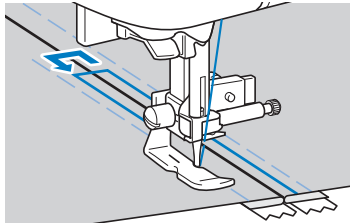
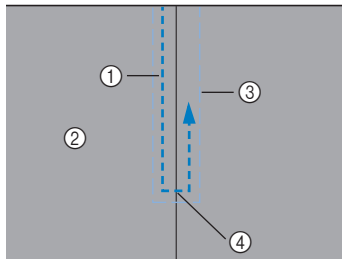

- ① Stitching
- ② Right side of fabric
- ③ Basting stitching
- ④ End of zipper opening

## ⚠ CAUTION

- When sewing, be sure that the needle does not touch the zipper, otherwise the needle may bend or break.

### 9 Remove the basting stitching.

## Inserting a piping

### 1 Place the piping between two layers of fabric, right sides together, as shown below.

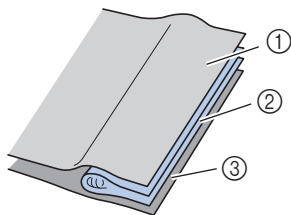

- ① Fabric
- ② Piping
- ③ Fabric

### 2 Refer to the steps of attaching the adjustable zipper/piping foot on page S-24.



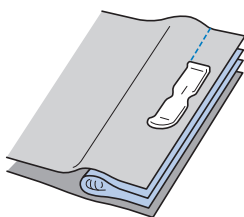

### 3 Sew along the piping.

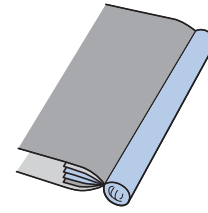

### 4 After sewing, turn them over.



## Sewing Stretch Fabrics and Elastic Tape

Stitch name	Stitch		Presser foot
		Stitch number	
Stem stitch		06*	J
2 steps elastic zigzag stitch		11	
3 steps elastic zigzag stitch		12*	
Tape attaching stitch		42	

\* Stitch patterns can be selected directly by pressing the numeric keys on the machine during preset utility stitch mode. Refer to "Basic operations" section.

### Stretch stitching

- 1 Attach zigzag foot "J".

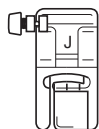

- 2 Select stitch .

- 3 Sew the fabric without stretching it.

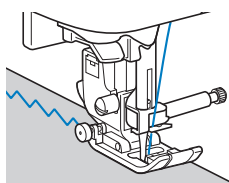

### Elastic attaching

When elastic tape is attached to the cuff or waist of a piece of clothing, the finished dimensions will be that of the stretched elastic tape. Therefore, it is necessary that a suitable length of the elastic tape be used.

- 1 Pin the elastic tape to the wrong side of the fabric.  
Pin the elastic tape to the fabric at a few points to make sure that the tape is uniformly positioned on the fabric.

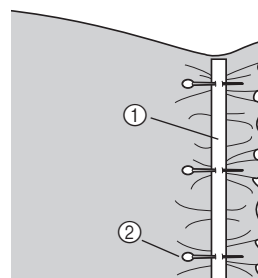

- ① Elastic tape
- ② Pin

- 2 Attach zigzag foot "J".

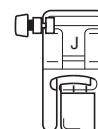

- 3 Select a stitch.

- 4 Sew the elastic tape to the fabric while stretching the tape so that it is the same length as the fabric.

While pulling the fabric behind the presser foot with your left hand, pull the fabric at the pin nearest the front of the presser foot with your right hand.

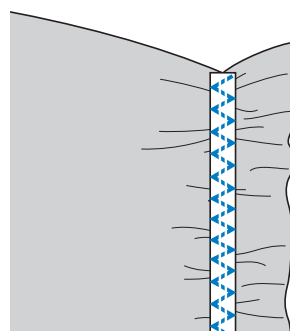
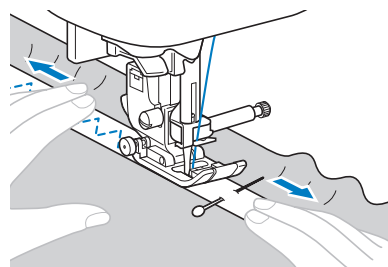











## ⚠ CAUTION

- When sewing, be sure that the needle does not touch any pins, otherwise the needle may bend or break.



# Appliqué, Patchwork and Quilt Stitching

Stitch name	Stitch	Stitch number	Presser foot
		Stitch number	
Zigzag stitch		08*	J
Quilting appliqué zigzag stitch		28	
Blanket stitch		33	
Quilting appliqué stitch		29	
Piecing stitch (Right)		25	
Piecing stitch (Middle)		26	
Patchwork join stitch		36	
Patchwork double overlock stitch		37	
Couching stitch		38	
Hand-look quilting stitch		27	
Quilting stippling stitch		30	

\* Stitch patterns can be selected directly by pressing the numeric keys on the machine during preset utility stitch mode. Refer to "Basic operations" section.

### Memo

- Patterns showing a "Q" in the table above are for quilting and those showing a "P" are for piecing.

## Appliqué stitching

- 1 Cut out the appliqué, leaving a seam allowance between 3 and 5 mm (1/8 and 3/16 inch).

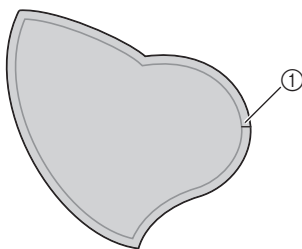

① Seam allowance

- 2 Place a pattern made of thick paper or stabilizer on the back of the appliqué, and then fold over the seam allowance using an iron.

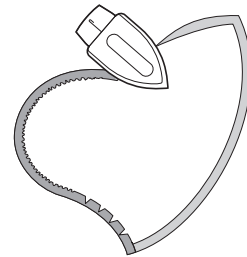

- 3 Turn the fabric over, and then baste or fuse it onto the fabric that it will be attached to.

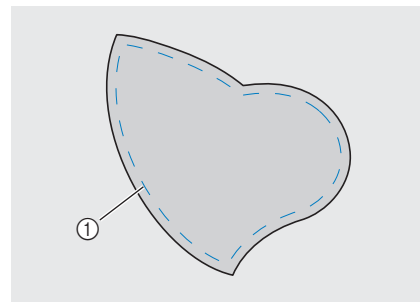

① Basting stitching

### Note

- If glue is used to hold the appliqué in place on the fabric, do not apply glue to areas that will be sewn with the machine. If glue adheres to the needle or bobbin case, the machine may be damaged.

- 4 Attach the zigzag foot "J" or the open toe foot (sold separately with some models) shown below.

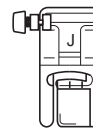

Zigzag foot "J"

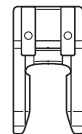

Open toe foot

- 5 Select a stitch.

- Turn the handwheel toward you (counterclockwise), and then begin sewing around the edge of the appliqué, making sure that the needle drops just outside of the appliqué.

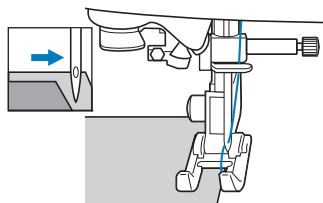

When sewing around corners, stop the machine with the needle in the fabric just outside of the appliqué, raise the presser foot lever, and then turn the fabric as needed to change the sewing direction.

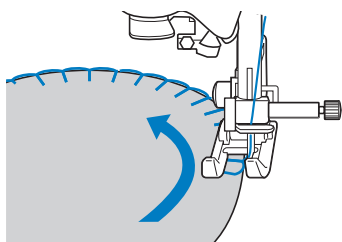

## Patchwork (crazy quilt) stitching

- Fold the edge of the top piece of fabric and place it over the lower piece.
- Sew the two pieces of fabric together so the pattern spans over both pieces.

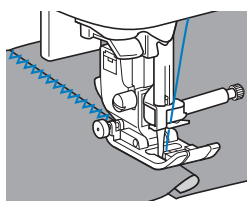



## Piecing

Sewing together two pieces of fabric is called “piecing”. The fabric pieces should be cut with a 6.5 mm (1/4 inch) seam allowance.

Sew a piecing straight stitch 6.5 mm (1/4 inch) from either the right side or the left side of the presser foot.

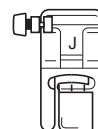
- Baste or pin along the seam allowance of the fabric that you wish to piece together.
- Attach zigzag foot “J”.



- Select stitch .

- Sew with the side of the presser foot aligned with the edge of the fabric.

### ■ For a seam allowance on the right side

Align the right side of the presser foot with the edge of the fabric, and sew using stitch .

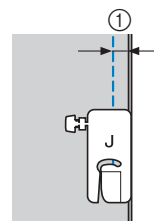

① 6.5 mm (1/4 inch)

### ■ For a seam allowance on the left side

Align the left side of the presser foot with the edge of the fabric, set the stitch width to 1.5 mm and sew using stitch .

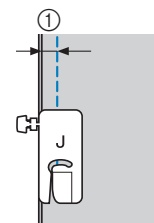

① 6.5 mm (1/4 inch)

### Memo

- To change the width of the seam allowance (needle position), adjust the stitch width. For details, refer to “Setting the stitch width” in the “Basic operations” section.

**■ Piecing using the 1/4" quilting foot with guide (sold separately with some models)**

This quilting foot can sew an accurate 1/4 inch or 1/8 inch seam allowance. It can be used for piecing together a quilt or for topstitching.

- 1 Press , and then attach the 1/4" quilting foot with guide.
- 2 Use the guide and marks on the presser foot to sew accurate seam allowances.

**Piecing a 1/4 inch seam allowance**

Sew keeping the edge of the fabrics against the guide.

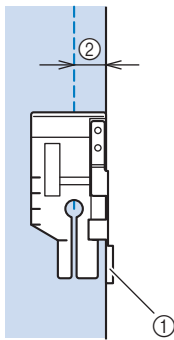

- 1 Guide
- 2 1/4 inch

**Creating an accurate seam allowance**

Use the mark on the foot to begin, end, or pivot 1/4 inch from edge of fabric.

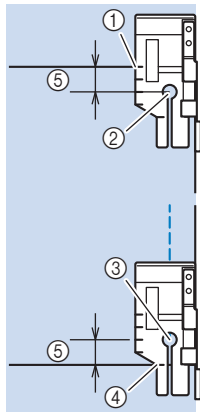

- 1 Align this mark with edge of fabric to begin.
- 2 Beginning of stitching
- 3 End of stitching
- 4 Opposite edge of fabric to end or pivot
- 5 1/4 inch

**Topstitching quilting, 1/8 inch**

Sew with the edge of the fabric aligned with the left side of the presser foot end.

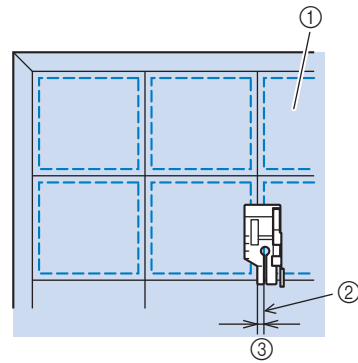



- 1 Surface of fabric
- 2 Seam
- 3 1/8 inch

**■ Using the 1/4" quilting foot (sold separately with some models)**

If the 1/4" quilting foot is used, seams can be sewn with a seam allowance of 6.4 mm (1/4 inch).

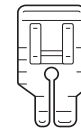
- 1 Baste or pin along the seam allowance of the fabric that you wish to piece together.
- 2 Attach the 1/4" quilting foot.



- 3 Select stitch .
- 4 Align the mark at the upper edge of the 1/4" quilting foot with the upper edge of the fabric.

Align the right edge of the fabric with the right edge of the narrow part of the 1/4" quilting foot.

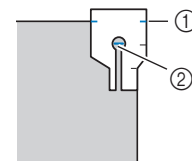

- 1 Mark on 1/4" quilting foot
- 2 Beginning of stitching

When sewing with a seam allowance, align the left edge of the narrow part of the 1/4" quilting foot with the fabric edge.

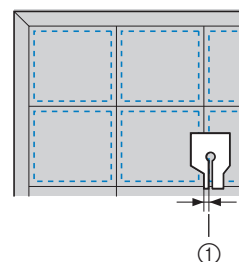

- 1 Seam (3.2 mm (1/8 inch))

**5 Start sewing.**

**6 When the end of the stitching is reached, stop the machine.**

Sew until the mark at the lower edge of the 1/4" quilting foot aligns with the lower edge of the fabric.

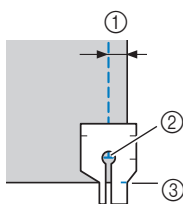

- ① 6.4mm (1/4 inch)
- ② End of stitching
- ③ Mark on 1/4" quilting foot

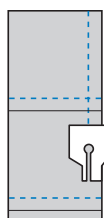

## Quilting

Sandwiching batting between the top and bottom layers of fabric is called "quilting". Quilts can easily be sewn using the walking foot\* and the quilting guide\*.

\* Sold separately with some models.

### Note

- Thread the needle manually when using the walking foot, or attach the walking foot only after threading the needle using the needle threader.
- When quilting, use a 90/14 home sewing machine needle.
- The walking foot can only be used with straight or zigzag stitch patterns. Do not sew reverse stitches with the walking foot.
- When sewing with the walking foot, sew at a speed between slow and medium.
- When using the walking foot, test sew on a scrap piece of fabric that is to be used in project.

**1 Baste the fabric to be quilted.**

**2 Remove the presser foot and the presser foot holder.**

- For details, refer to "Removing and attaching the presser foot holder" in the "Basic operations" section.

**3 Hook the connecting fork of the walking foot onto the needle clamp screw.**

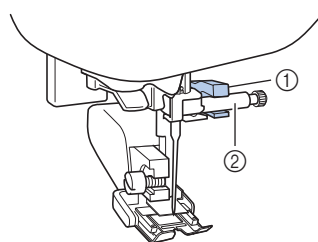

- ① Connecting fork
- ② Needle clamp screw

**4 Lower the presser foot lever, insert the presser foot holder screw, and then tighten the screw with the screwdriver.**

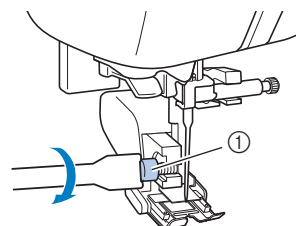

- ① Presser foot holder screw

## CAUTION

- Be sure to securely tighten the screws with the screwdriver, otherwise the needle may touch the presser foot, causing it to bend or break.
- Before starting to sew, slowly turn the handwheel toward you (counterclockwise) and check that the needle does not touch the presser foot. If the needle hits the presser foot, the needle may bend or break.

**5 Select a stitch.**

**6 Place one hand on each side of the presser foot, and then evenly guide the fabric while sewing.**

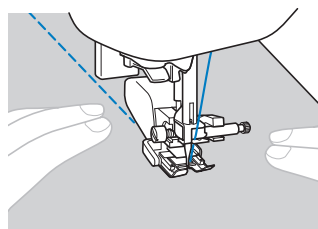

■ **Using the quilting guide (sold separately with some models)**

Use the quilting guide to sew parallel stitches that are equally spaced.

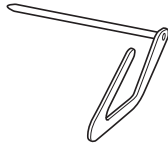

1 Insert the stem of the quilting guide into the hole at the rear of the walking foot or presser foot holder.

Walking foot

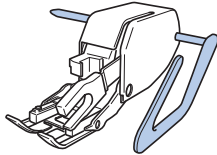

Presser foot holder

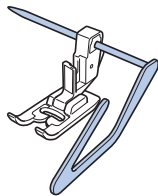

2 Adjust the stem of the quilting guide so that the guide aligns with the seam that has already been sewn.

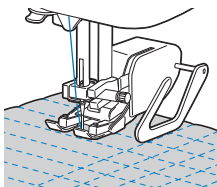

**Free motion quilting**

We recommend attaching the foot controller and sewing at a consistent speed. You can adjust the sewing speed with the speed control slide on the machine.

**CAUTION**

- With free motion quilting, control the feeding speed of the fabric to match the sewing speed. If the fabric is moved faster than the sewing speed, the needle may break or other damage may result.

■ **Using free motion open toe quilting foot “O”\* or quilting foot\***

\* Sold separately with some models.

The free motion open toe quilting foot “O” or quilting foot is used for free motion quilting with zigzag or decorative stitches or for free motion quilting of straight lines on fabric with an uneven thickness. Various stitches can be sewn using free motion open toe quilting foot “O”. For details on the stitches that can be used, refer to “Stitch Setting Chart” in the “Basic operations” section.

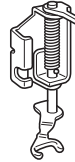

Free motion open toe quilting foot “O”

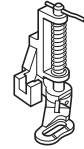

Quilting foot

1 Slide the feed dog position switch, located at the rear of the machine on the base, to  (to the left as seen from the rear of the machine).

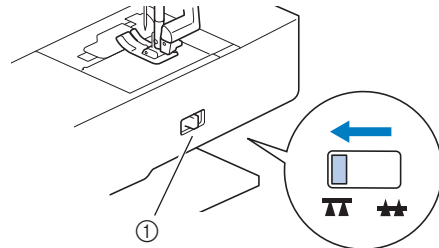

- ① Feed dog position switch (as seen from the rear of the machine)
- The feed dogs are lowered.

2 Select a stitch.

3 Remove the presser foot holder.

- For details, refer to “Removing and attaching the presser foot holder” in the “Basic operations” section.

4 Attach the quilting foot by positioning the pin of the quilting foot above the needle clamp screw and aligning the lower-left of the quilting foot and the presser bar.

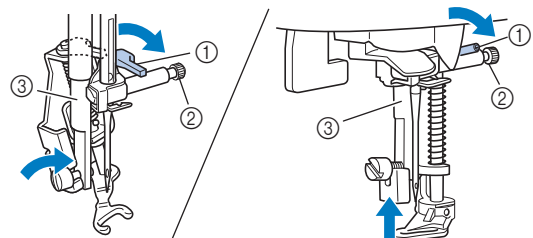

- ① Pin
- ② Needle clamp screw
- ③ Presser bar



**Note**

- Make sure that the quilting foot is not slanted.

- 5 Hold the quilting foot in place with your right hand, and tighten the presser foot holder screw using the screwdriver with your left hand.

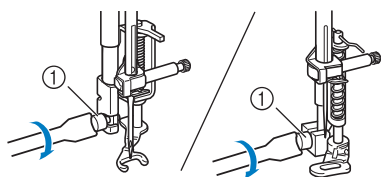

① Presser foot holder screw

## CAUTION

- Be sure to securely tighten the screws with the included screwdriver. Otherwise, the needle may touch the quilting foot, causing it to bend or break.

- 6 Use both hands to stretch the fabric taut, and then move the fabric at a consistent pace in order to sew uniform stitches roughly 2.0 mm - 2.5 mm (approx. 1/16 inch - 3/32 inch) in length.

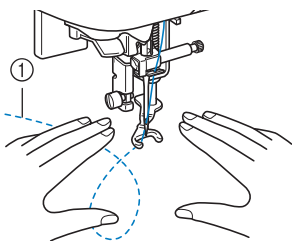

① Stitch

- 7 After sewing is finished, slide the feed dog position switch lever to (to the right as seen from the rear of the machine) and turn the handwheel to raise the feed dogs.



### Memo

- Do not be discouraged with your initial results. The technique requires practice.

## Satin stitching using the sewing speed controller

A decorative stitch can be sewn by changing the stitch width of a satin stitch. If the machine is set so that the stitch width can be adjusted using the sewing speed controller, the stitch width can quickly and easily be adjusted. When this function is set, the foot controller must be used to sew.

- 1 Connect the foot controller.
- 2 Attach zigzag foot "J".

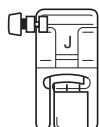

- 3 Press to turn on the stitch width control function.

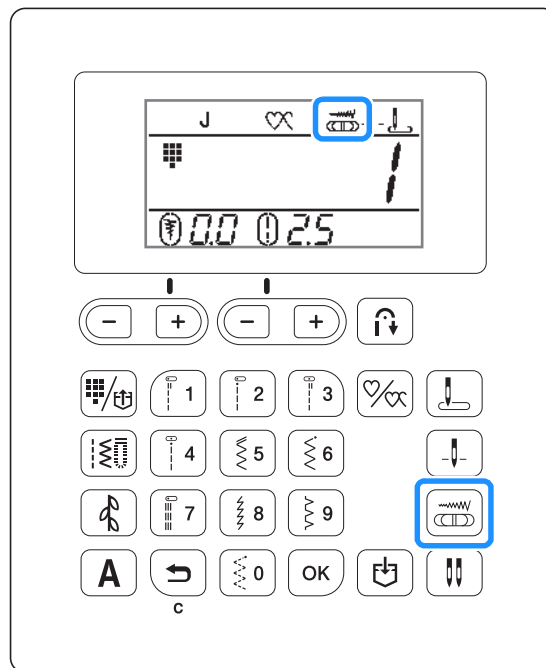

→ The machine is now set so that the stitch width can be controlled with the sewing speed controller.

- 4 Select stitch .

- 5 While sewing, slide the sewing speed controller to adjust the stitch width.

Slide the controller to the left to make the width narrower. Slide the controller to the right to make the width wider.

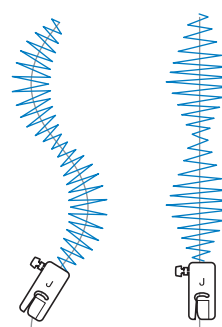
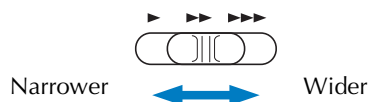

- Adjust the sewing speed with the foot controller.

- 6 When you are finished sewing, press to turn off the stitch width control function.







### Memo

- Although the stitching result differs depending on the type of fabric being sewn and the thickness of the thread being used, for best results, adjust the stitch length to between 0.3 and 0.5 mm (1/64 and 1/32 inch).

## Reinforcement Stitching

Reinforce points that will be subject to strain, such as sleeve holes, inseams and pocket corners.

Stitch name	Stitch	Stitch number	Presser foot
			
Triple stretch stitch		05*	J
Bar tack stitch		67	A
Darning stitch		65	
		66	

\* Stitch patterns can be selected directly by pressing the numeric keys on the machine during preset utility stitch mode. Refer to "Basic operations" section.

### Triple stretch stitching

Use triple stretch stitching to reinforce sleeve holes and inseams.

- 1 Attach zigzag foot "J".

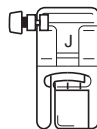

- 2 Select stitch .

- 3 Start sewing.

### Bar tack stitching

Bar tacks are used to reinforce points subject to strain, such as pocket corners and openings.

As an example, the procedure for sewing bar tacks at pocket corners is described below.

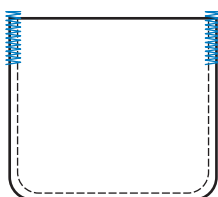

- 1 Determine the desired length of the bar tack.

Set the button guide plate on buttonhole foot "A" to the desired length. (The distance between the markings on the presser foot scale is 5 mm (3/16 inch).)

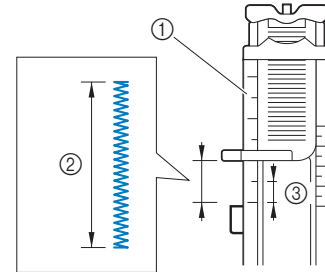

- 1 Presser foot scale
- 2 Length of bar tack
- 3 5 mm (3/16 inch)

- A bar tack with a maximum length of about 28 mm (1-1/8 inches) can be sewn.

- 2 Attach buttonhole foot "A".

- 3 Select stitch .

- 4 Position the fabric so that the opening of the pocket faces toward you, and then lower the presser foot lever so that the needle drops 2 mm (1/16 inch) in front of the pocket opening.

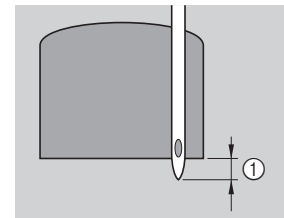

- 1 2 mm (1/16 inch)

Pass the upper thread down through the hole in the presser foot.

- When lowering the presser foot, do not push in the front of the presser foot, otherwise the bar tack will not be sewn with the correct size.

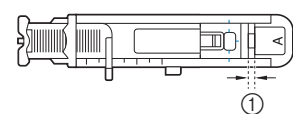
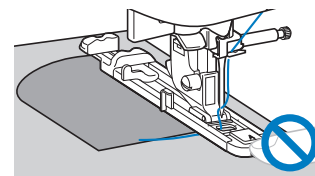

- 1 Do not reduce the gap.

**5 Pull down the buttonhole lever as far as possible.**

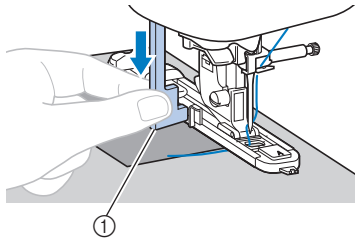

① Buttonhole lever  
The buttonhole lever is positioned behind the bracket on the buttonhole foot.

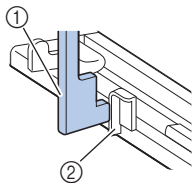

① Buttonhole lever  
② Bracket

**6 Gently hold the end of the upper thread in your left hand, and then start sewing.**

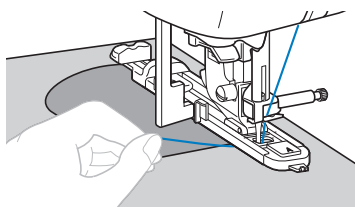

**7 Raise the presser foot lever, remove the fabric, and then cut the threads.**

**8 Raise the buttonhole lever to its original position.**

**Memo**

- If the fabric does not feed, for example, because it is too thick, increase the stitch length. For details, refer to “Setting the stitch length” in the “Basic operations” section.

**Darning**

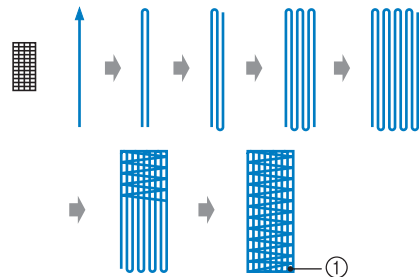
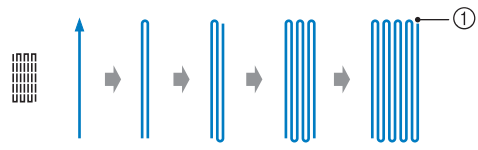

① Reinforcement stitching

**1 Determine the desired length of the darning.**

Set the button guide plate on buttonhole foot “A” to the desired length. (The distance between the markings on the presser foot scale is 5 mm (3/16 inch).)

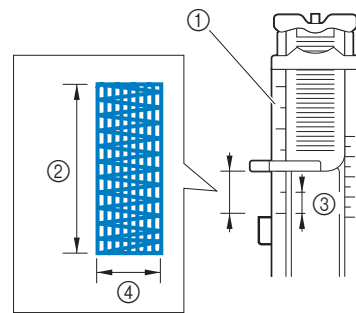

① Presser foot scale  
② Length of darning  
③ 5 mm (3/16 inch)  
④ 7 mm (1/4 inch)

- A bar tack with a maximum length of about 28 mm (1-1/8 inches) can be sewn.

→ Once sewing is completed, the machine automatically sews reinforcement stitches, then stops.

**2 Attach buttonhole foot “A”.**

**3 Select stitch  or .**



- 4** Position the fabric so that the needle is 2 mm (1/16 inch) in front of the area to be darned.

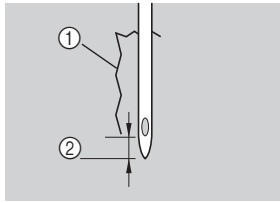

- ① Tear  
② 2 mm (1/16 inch)

Pass the upper thread down through the hole in the presser foot, and then lower the presser foot.

- When lowering the presser foot, do not push in the front of the presser foot, otherwise the darning will not be sewn with the correct size.

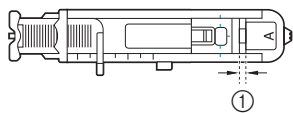
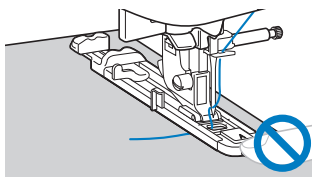

- ① Do not reduce the gap.

- 5** Pull down the buttonhole lever as far as possible.

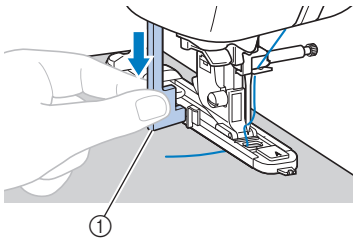

- ① Buttonhole lever  
The buttonhole lever is positioned behind the bracket on the buttonhole foot.

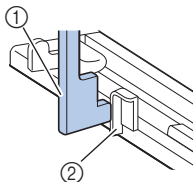

- ① Buttonhole lever  
② Bracket

- 6** Gently hold the end of the upper thread in your left hand, and then start sewing.

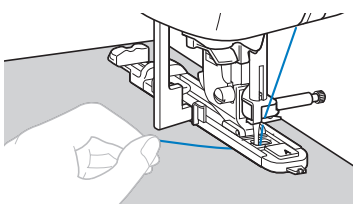

- 7** Raise the presser foot lever, remove the fabric, and then cut the threads.

- 8** Raise the buttonhole lever to its original position.

### Memo

- If the fabric does not feed, for example, because it is too thick, increase the stitch length. For details, refer to "Setting the stitch length" in the "Basic operations" section.

## Eyelet Stitching

Eyelets, such as those on belts, can be sewn.

Stitch name	Stitch	MM	Presser foot
		Stitch number	
Eyelet stitch		69	N

- 1 Attach monogramming foot "N".

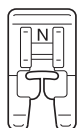

- 2 Select stitch .

- 3 Adjust either the stitch width or the stitch length to select the desired eyelet size.

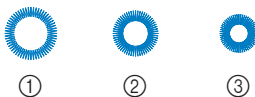

- ① 7 mm (approx. 1/4 inch)
- ② 6 mm (approx. 15/64 inch)
- ③ 5 mm (approx. 3/16 inch)

- For details, refer to "Setting the stitch width" and "Setting the stitch length" in the "Basic operations" section.

- 4 Lower the needle into the fabric at the beginning of the stitching, and then lower the presser foot lever.

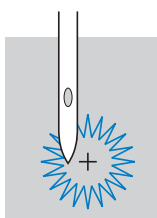

- 5 Start sewing.

→ Once sewing is completed, the machine automatically sews reinforcement stitches, then stops.

- 6 Use the eyelet punch to cut a hole in the center of the eyelet.

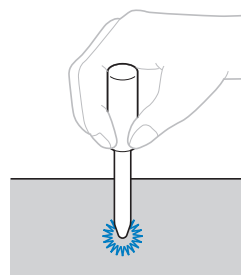

















- When using the eyelet punch, place thick paper or some other protective sheet under the fabric before punching the hole in the fabric.

### Memo

- If thin thread is used, the stitching may be too open. If this occurs, sew the eyelet twice before removing the fabric, one on top of the other.

## Decorative Stitching

The utility stitches contain the following decorative stitches.

Stitch name	Stitch	Stitch number	Presser foot
Patchwork join stitch		36	J
Patchwork double overlock stitch		37	
Couching stitch		38	
Shell tuck edge stitch		34	
Smocking stitch		39	
Feather stitch		40	
Fagoting cross stitch		41	
Satin scallop stitch		35	N
Hemstitching		48	
		50	
		52	
		56	
Ladder stitch		43	J
Rick-rack stitch		44	
Decorative stitch		45	
Serpentine stitch		46	

## Fagoting

Stitching across an open seam is called "fagoting". It is used on blouses and children's clothing. This stitch is more decorative when thicker thread is used.

- 1 Use an iron to fold the two pieces of fabric along their seams.
- 2 Baste the two pieces of fabric, separated by about 4 mm (3/16 inch), onto thin paper or a sheet of water-soluble stabilizer.

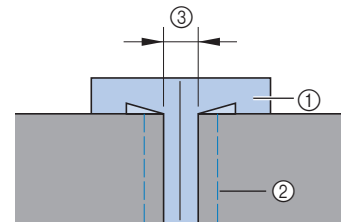

If you draw a line down the middle of the thin paper or water-soluble stabilizer, sewing is easier.

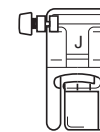

- ① Thin paper or water soluble stabilizer
- ② Basting stitching
- ③ 4 mm (3/16 inch)

- 3 Attach zigzag foot "J".



- 4 Select stitch  or .
- 5 Set the stitch width to 7.0 mm (1/4 inch).
- 6 Sew with the center of the presser foot aligned along the center of the two pieces of fabric.

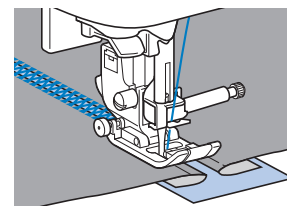
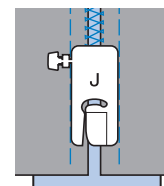



- 7 After sewing is finished, remove the paper.

## Scallop stitching

The wave-shaped repeated pattern that looks like shells is called “scalloping”. It is used on the collars of blouses and to decorate the edges of projects.

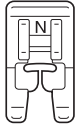
- 1 Attach monogramming foot “N”.



- 2 Select stitch .

- 3 Stitch along the edge of the fabric, making sure not to sew directly on the edge of the fabric.

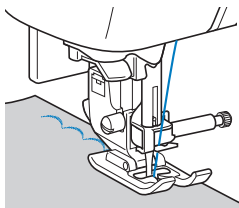

- For better results, apply spray starch onto the fabric and press with a hot iron before it is sewn.

- 4 Trim along the stitches.

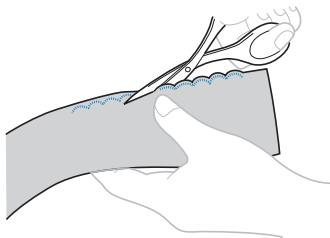

- Be careful not to cut the stitches.

## Smocking

The decorative stitch created by stitching or embroidering over gathers is called “smocking”. It is used to decorate the front of blouses or cuffs.

The smocking stitch adds texture and elasticity to fabric.

- 1 Attach zigzag foot “J”.

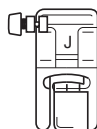

- 2 Select the straight stitch, and then adjust the stitch length to 4.0 mm (3/16 inch) and loosen the thread tension.

- For details, refer to “Setting the stitch length” and “Setting the thread tension” in the “Basic operations” section.
- For details, refer to “Pulling up the bobbin thread” in the “Basic operations” section.

- 3 Sew parallel stitching at intervals of 1 cm (3/8 inch).

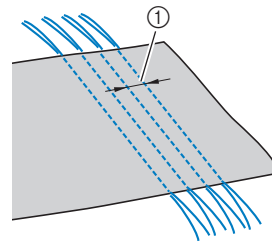

- ① 1 cm (3/8 inch)

- Do not use reverse/reinforcement stitching or thread cutting.
- At the end of the stitching, the thread is pulled out about 5 cm (2 inches).

- 4 Pull the bobbin threads to create gathers. Smooth the gathers by ironing them.

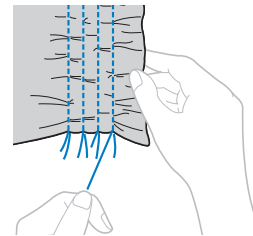

- 5 Select stitch , , or .

- 6 Stitch between the straight stitches.

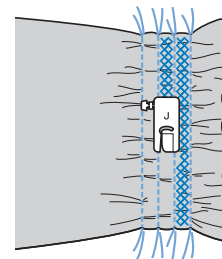

- 7 Pull out the threads for the straight stitches.

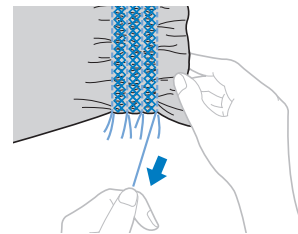

## Shell tuck stitching

The gathers that look like shells are called “shell tucks”. They are used to decorate trims, the front of blouses or cuffs made of thin fabrics.

- 1 Fold the fabric along the bias.

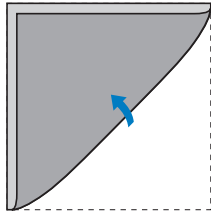

- 2 Attach zigzag foot “J”.

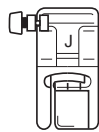

- 3 Select stitch , and then increase the thread tension.

- 4 Sew while making sure that the needle drops slightly off the edge of the fabric.

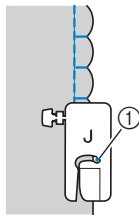

- 1 Needle drop point

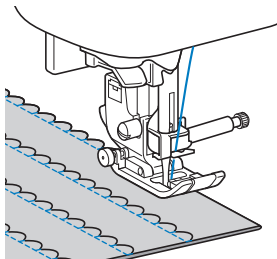

- 5 Unfold the fabric, and then iron the tucks down to one side.

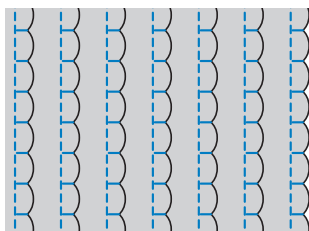

## Joining

Decorative bridging stitches can be sewn over the seam allowance of joined fabrics. This is used when making a crazy quilt.

- 1 Attach zigzag foot “J”.

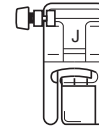

- 2 Sew together the right sides of the two pieces of fabric, and then open up the seam allowances.

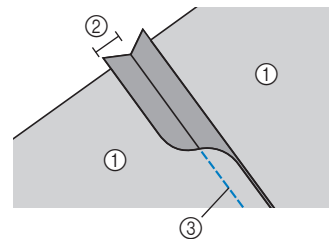

- 1 Wrong side of fabric
- 2 7 mm (1/4 inch) seam allowance
- 3 Straight stitch

- 3 Select stitch ,  or .

- 4 Turn the fabric over so that the right side faces up, and then sew over the seam with the center of the presser foot aligned with the seam.

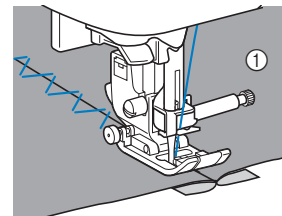

- 1 Right side of fabric

## Heirloom stitching

When sewing with the wing needle, the needle holes are enlarged, creating a lace-like decorative stitch. This is used to decorate hems and tablecloths on thin or medium weight fabrics in addition to plain weave fabrics.

### 1 Install the wing needle.

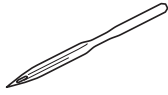

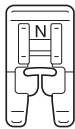

- Use a 130/705H 100/16 wing needle.
- For details on installing a needle, refer to “Replacing the Needle” in the “Basic operations” section.
- The needle threader cannot be used with the wing needle, otherwise the machine may be damaged. Manually pass the thread through the eye of the needle from the front to the back. For details, refer to “Threading the needle manually (without using the needle threader)” in the “Basic operations” section.

### 2 Attach monogramming foot “N”.



### 3 Select a stitch.

The stitches that can be used are  or .

- When sewing with the wing needle, select a stitch width of 6.0 mm (15/64 inch) or less.

### 4 Start sewing.

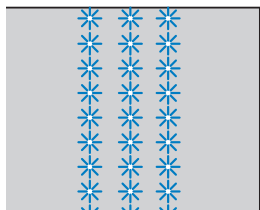

## ⚠ CAUTION

- When sewing with the wing needle, select a stitch width of 6.0 mm (15/64 inch) or less, otherwise the needle may bend or break.
- After adjusting the stitch width, slowly turn the handwheel toward you (counterclockwise) and check that the needle does not touch the presser foot. If the needle hits the presser foot, the needle may bend or break.

Partially removing threads is called “drawnwork”. This gives beautiful results with fabrics that have a loose weave.

The procedure for creating drawnwork is described below.

## ■ Drawnwork

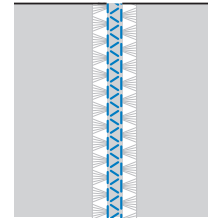

### 1 Pull out several threads from two sections of the fabric, separated by an unfrayed section of about 4 mm (3/16 inch).

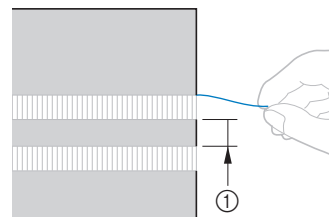

① 4 mm (3/16 inch)

### 2 Attach monogramming foot “N”.

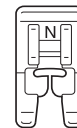

### 3 Select stitch .

### 4 Sew along the center of the unfrayed section.

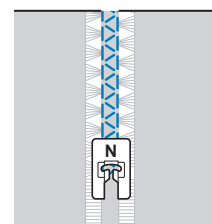

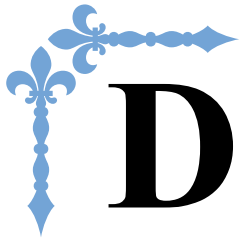

# Decorative sewing

This section provides instructions on sewing character stitches and decorative stitches as well as on adjusting and editing them.

Page number starts with “D” in this section.

The screen display and machine illustration may vary slightly, depending on the machine model.

## **Chapter1 CHARACTER / DECORATIVE STITCHES..... D-2**

---

### **⚠ CAUTION**

- Before replacing the presser foot, be sure to turn off the machine, otherwise injuries may occur if the “Start/Stop” button or any other button is pressed and the machine starts operating. For details on changing the presser foot, refer to “Replacing the Presser Foot” in the “Basic operations” section.

# Chapter 1 CHARACTER / DECORATIVE STITCHES

## Sewing the Various Built-in Decorative Patterns

### Selecting stitch patterns

This machine is equipped with the decorative stitches and character stitches.

#### When selecting a decorative stitch

The category  contains the following four types of stitches:

- Decorative stitches: 
- Satin stitches: 
- 7 mm satin stitches: 
- Cross stitch stitches: 

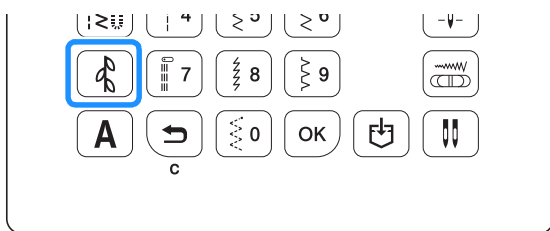

1 Press .



→  is displayed on the LCD screen.



2 Enter the number of the desired stitch using numeric keys, and then press .

- For number of each stitch, refer to the Quick Reference Guide.
- Depending on the stitch number, the stitch may be selected without pressing .
- When using one-digit numbers and it is entered incorrectly, press  to erase the entered number.

→ The number for the selected stitch appears in the LCD.

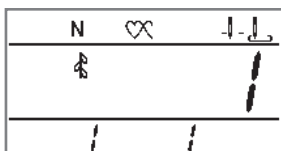

#### When selecting a character stitch

1 Press  repeatedly to display the icon of the desired font.

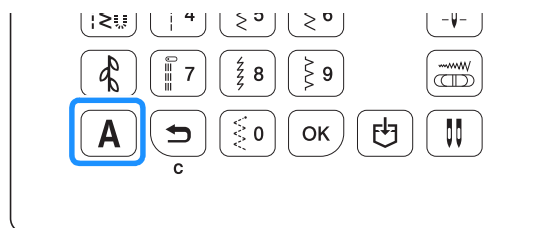

- Each time the  is pressed, it changes the font in the following order.



A 1 → A 2 → A 3 → A 4 → A 1...

Icon	Font
A 1	Gothic
A 2	Handwriting
A 3	Outline
A 4	Japanese

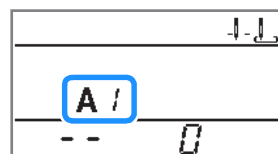
→ The icon for the selected font appears in the LCD.



2 Enter the number of the desired character stitch using numeric keys.

- For number of each stitch, refer to the Quick Reference Guide, and then press .
- Depending on the stitch number, the stitch may be selected without pressing .
- When a digit is incorrectly pressed, press  to erase the entered number.

→ The number for the selected stitch appears on the LCD.

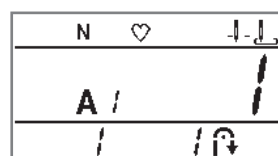



## Deleting a pattern

To remove a selected pattern, press  on the operation panel.

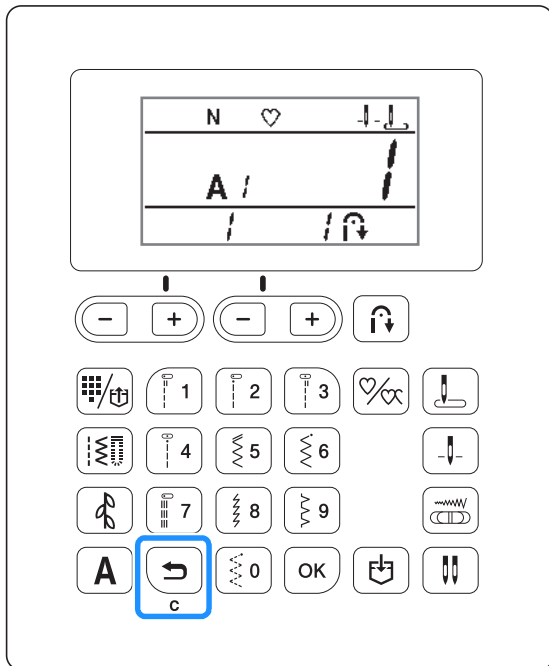

→ The selected pattern is removed.

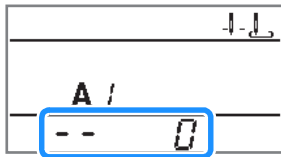

### Memo

- If a new pattern is selected without deleting the previously selected one, the first and second patterns are combined. (Refer to “Combining patterns” on page D-5.)
- If two patterns or more have been already selected, the pattern that was selected last is removed.
- You can delete the entire combined pattern by pressing .

## Sewing attractive finishes

To achieve attractive results when sewing character/decorative stitches, check the table below for the proper fabric/thread/needle combinations.

### Note

- Other factors, such as fabric thickness, stabilizer material, etc., also have an effect on the stitch, so you should always sew a few trial stitches before beginning your project.
- It may be necessary to adjust the pattern, depending on the type of fabric being sewn or the sewing speed. Adjust the pattern while sewing trial stitches on a scrap piece of fabric that is the same as what is used in your project. Refer to “Realigning the pattern” on page D-7.
- When sewing satin stitch patterns, there may be shrinking or bunching of stitches, so be sure to attach a stabilizer material.
- Guide the fabric with your hand to keep the fabric feeding straight and even during sewing.

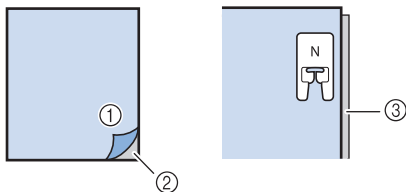
Fabric	When sewing on stretch fabrics, lightweight fabrics, or fabrics with coarse weaves, attach stabilizer on the wrong side of the fabric. An alternative would be to place the fabric on thin paper such as tracing paper.
	
	<ul style="list-style-type: none"> <li>① Fabric</li> <li>② Stabilizer</li> <li>③ Thin paper</li> </ul>
Thread	#50 - #60
Needle	With lightweight, regular, or stretch fabrics: the Ball point needle (golden colored) 90/14 With heavyweight fabrics: home sewing machine needle 90/14
Presser foot	Monogramming foot “N”. Using zigzag foot “J” or other presser feet may give inferior results.
Twin needle	You can sew with twin needle (2/11) when you select 7 mm satin stitch pattern. In this case, use zigzag foot “J”.

## Basic sewing

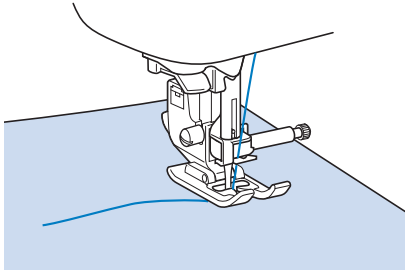

- 1 Select a decorative/character stitch pattern.
- 2 Attach monogramming foot "N".
- 3 Place the fabric under the presser foot, pull the upper thread out to the side, press  (Needle position button) to lower needle into fabric and then lower the presser foot.



- 4 Press the "Start/Stop" button to begin sewing.

### Memo

- If the fabric is pulled or pushed during sewing, the pattern may not turn out correctly. Guide the fabric with your hand to keep the fabric feeding straight and even during sewing.

- 5 Press the "Start/Stop" button to stop sewing.
- 6 Press  (Reverse stitch button) or  (Reinforcement stitch button) to sew reinforcement stitches.

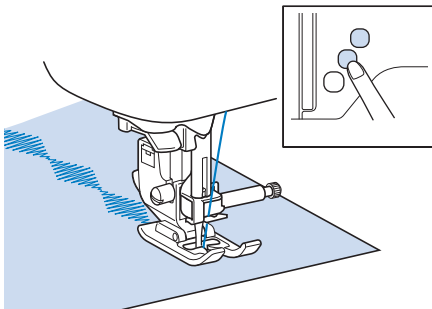

### Memo

- When sewing character stitches, the machine automatically sews reinforcement stitches at the beginning and end of each character.

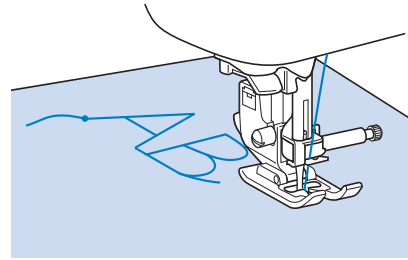

- When sewing is completed, trim any excess thread between letters.

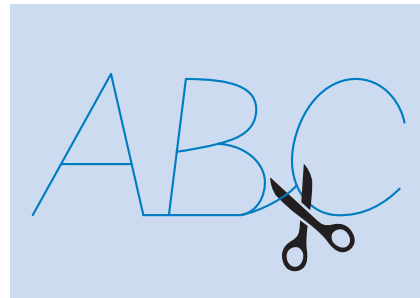

### Note





- When sewing some patterns, the needle will temporarily pause in the raised position while the fabric is fed due to the operation of the needle bar separation mechanism which is used in this machine. At such times, a clicking sound different from the sound generated during sewing will be heard. This sound is normal and is not the sign of a malfunction.

## Combining patterns

You can sew names, etc., by combining character stitches. Character stitches and decorative stitches can also be combined.

**Example:** RLEAFR

Selecting stitches:

Stitch pattern	Category	Stitch number
		13
L	A /	12
E		5
A		1
F		6
		13

1 Press  to display "".

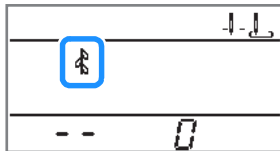

2 Use the numeric keys to enter "13".

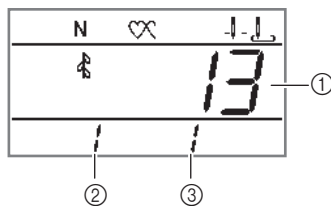

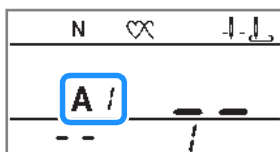

- ① Stitch number
- ② Position number
- ③ Total number

3 Press **A** to display "A /".

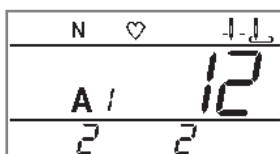

4 Use the numeric keys to enter "12".



5 Use the numeric keys to enter "5", and then press . And add "A" (No. 1) and "F" (No. 6).

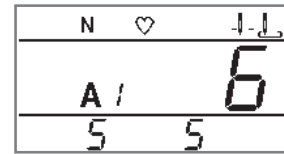

6 Press  to display "".

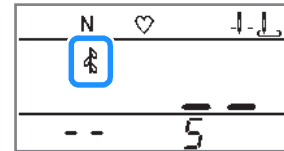

7 Use the numeric keys to enter "13".

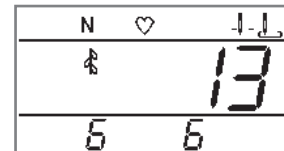

- To remove a selected pattern, press  on the operation panel. The pattern that was selected last is removed.





8 After combining the patterns, check the entered characters and their order before stitching.

- For details, refer to "Checking the selected pattern" on page D-6.

9 After all of the desired patterns are selected, start sewing.

- The order in which the patterns are selected is the order that they will be sewn.

### Memo

- Up to 70 patterns can be combined.
- If multiple patterns have been combined, the sewing machine stops once all the selected patterns displayed in the LCD have been sewn. To repeatedly sew the combined pattern, refer to "Repeating combined patterns" on page D-6.
- The combined pattern can be stored for later use. For details, refer to "Saving a pattern" on page D-6.
- You can delete all patterns being combined by pressing  while combining patterns.
- If you mistakenly press  while combining patterns, press  or **A**, and then enter "00" by using the numeric key. You can retrieve the patterns that you combined before you pressed . If necessary, save the retrieved pattern in the machine's memory. For details, refer to "Saving a pattern" on page D-6.

## Checking the selected pattern

You can check the combined patterns.

**1** Press the “-” or “+” key, and confirm the pattern.

- You can check the stitch number and the order of the patterns.

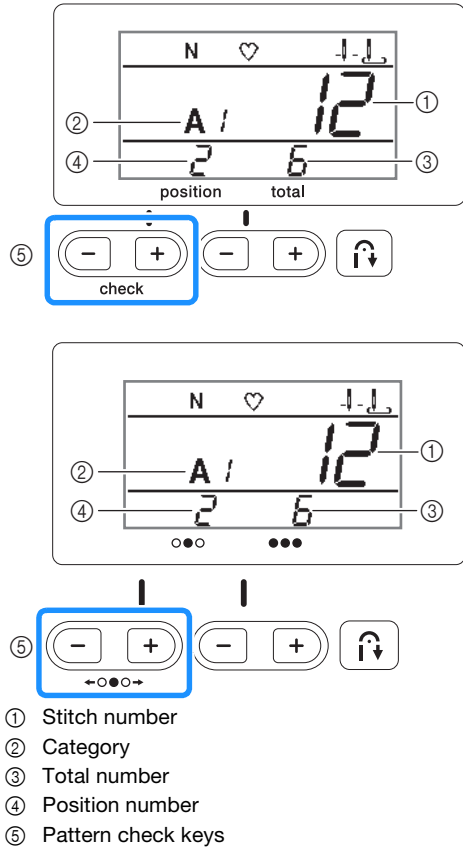

**Memo**



- The combined pattern can be stored for later use. For details, refer to “Saving a pattern” on page D-6.

## Repeating combined patterns

When multiple stitch patterns are combined, the sewing machine will stop stitching after the last entered pattern number appears on screen has completed sewing. Use the following operations to sew a combined pattern repeatedly.

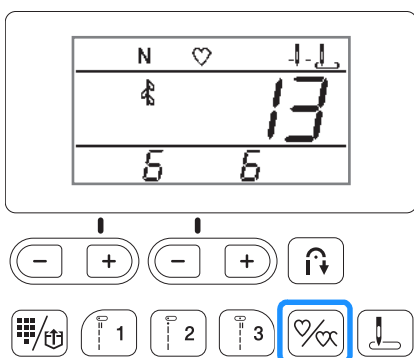
**1** After the patterns have been combined, press .



→  on the LCD screen turns to , and you can now sew the specified pattern repeatedly.

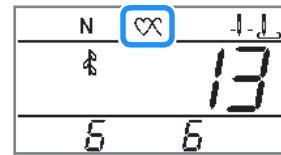

→ If pressed again, it turns to  (single sewing), and machine will stop sewing at end of combined patterns.



**Note**

- If repeated sewing is set, the pattern is repeatedly sewn until the sewing machine is stopped.
- If the sewing machine is turned off, the repeated/single sewing setting returns to its default setting.

## Saving a pattern

Combined patterns can be stored for later use. Since stored patterns are not lost after the sewing machine is turned off, they can be recalled at any time. Only one pattern combination can be stored.

**1** Create the combined pattern that you wish to store.

- For details, refer to “Combining patterns” on page D-5.

**2** Press  on the operation panel.

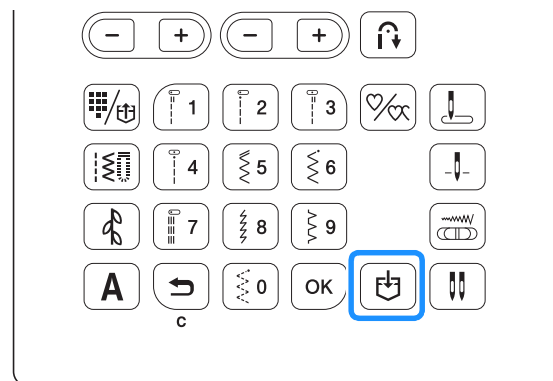

- Do not turn off the sewing machine while the pattern is being stored, otherwise the pattern data may be lost.



**Memo**

- When a pattern is saved in the machine where an existing pattern is already saved, the stitch is overwritten.
- Once the pattern has been saved in pocket, it can not be deleted without overwriting. When you wish to clear saved pattern, press  without selecting a pattern.

## Retrieving a pattern

- 1 Press  once or twice until a screen of saved patterns like the one shown below appears.

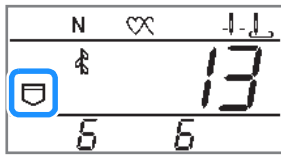

→ When a saved pattern is retrieved, the pocket appears.

### Memo

- You can check the combined patterns. For details, refer to “Checking the selected pattern” on page D-6.
- To add new patterns, select the desired category, and then enter the number of the stitch.

## Realigning the pattern

The pattern may not be sewn correctly, depending on the type of fabric being sewn or the sewing speed. If this occurs, adjust the pattern while sewing on a piece of scrap fabric that is the same as what is used for your project.

- 1 Attach monogramming foot “N”.

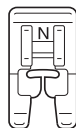

- 2 Press , and then enter “99” with the numeric keys.

- 3 Start sewing.

→ The sewing machine stops after it has finished sewing the pattern.

- 4 Check the sewn pattern.

If the part of the pattern indicated in the illustration is sewn uniformly, the pattern is correctly aligned.

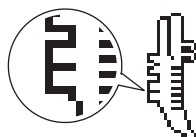

If the pattern is not sewn correctly, follow the steps below to align the stitching.

- 5 Press the “-” or “+” key to adjust the vertical position.

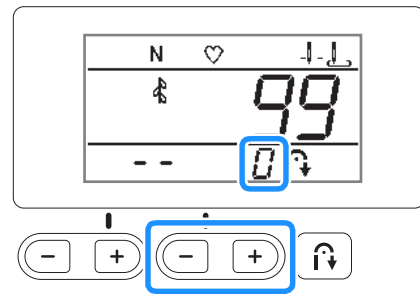

→ Make the necessary adjustments according to how the pattern is sewn.

- If the pattern is bunched:  
Press “+” to increase the vertical space in the design.

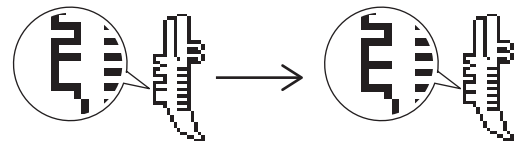

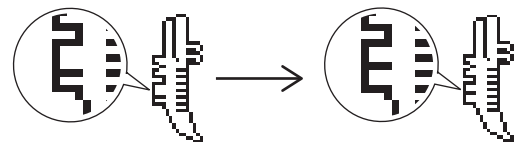

- If the pattern has gaps:  
Press “-” to decrease the vertical space in the design.



- 6 Start the sewing machine and check the stitching.

Continue adjusting the pattern until it is sewn correctly.

### Memo

- To finish realigning the pattern, press , , **A** or any of the numeric keys.
- After the pattern is realigned, the patterns selected before realignment are deleted. To retrieve the patterns selected before realignment, press  or **A**, and then enter “00” with the numeric keys.



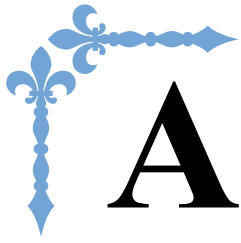

# Appendix

This section provides important information for operating this machine. Please read this section to find troubleshooting tips and pointers as well as how to keep your machine in the best working order. Page number starts with "A" in this section.

## **Chapter1 MAINTENANCE AND TROUBLESHOOTING ..... A-2**

---

# Chapter 1 MAINTENANCE AND TROUBLESHOOTING

## Care and Maintenance

### Restrictions on oiling

In order to prevent damaging this machine, it must not be oiled by the user.

This machine was manufactured with the necessary amount of oil applied to ensure correct operation, making periodic oiling unnecessary.

If problems occur, such as difficulty turning the handwheel or an unusual noise, immediately stop using the machine, and contact your authorized Brother dealer or the nearest Brother authorized service center.

### Precautions on storing the machine

Do not store the machine in any of the locations described below, otherwise damage to the machine may result, for example, rust caused by condensation.

- Exposed to extremely high temperatures
- Exposed to extremely low temperatures
- Exposed to extreme temperature changes
- Exposed to high humidity or steam
- Near a flame, heater or air conditioner
- Outdoors or exposed to direct sunlight
- Exposed to extremely dusty or oily environments



#### Note

- In order to extend the life of this machine, periodically turn it on and use it. Storing this machine for an extended period of time without using it may reduce its efficiency.

### Cleaning the LCD screen

If the surface of the LCD is dirty, lightly wipe it with a soft dry cloth.



#### Note

- Do not wipe the LCD screen with a damp cloth.



#### Memo

- Occasionally, condensation may form on the LCD screen or it may become fogged up; however, this is not a malfunction. After a while, the cloudiness will disappear.

### Cleaning the machine surface

When wiping dirt off the machine, firmly wring a soft cloth soaked in (lukewarm) water.

After cleaning the machine, dry it with a soft, dry cloth.

### ⚠ CAUTION

- Unplug the power cord before cleaning the machine, otherwise injuries or an electric shock may occur.

### Cleaning the race

Sewing performance will suffer if lint and dust collects in the bobbin case, therefore, it should be cleaned regularly.

- 1 Press  (Needle position button) to raise the needle.
- 2 Turn off the machine.
- 3 Unplug the power cord from the power supply jack on the right side of the machine.

### ⚠ CAUTION

- Unplug the power cord before cleaning the machine, otherwise injuries or an electric shock may occur.

- 4 Raise the presser foot to remove the needle, presser foot and presser foot holder.
  - For details, refer to "Replacing the Needle" and "Replacing the Presser Foot" in the "Basic operations" section.
- 5 Remove the flat bed attachment if it is attached.
- 6 Remove the needle plate cover.



■ **If there is a screw in the needle plate cover**

- 1 Use the disc shaped screwdriver to remove the screw in the needle plate cover.

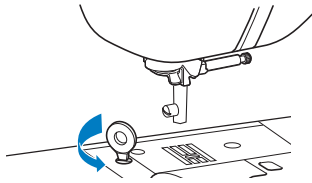

 **Memo**

- (For models that include the L-shaped screwdriver)

You can also use the L-shaped screwdriver to remove the screw in the needle plate cover.

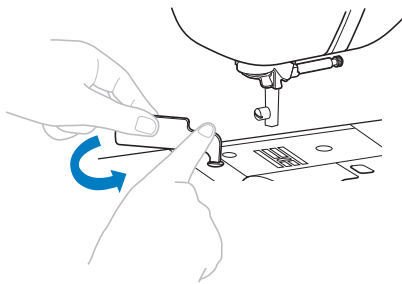

- 2 Grasp both sides of the needle plate cover, and then slide it toward you.

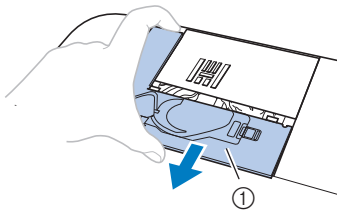

① Needle plate cover

■ **If there is no screw in the needle plate cover**

- 1 Grasp both sides of the needle plate cover, and then slide it toward you.

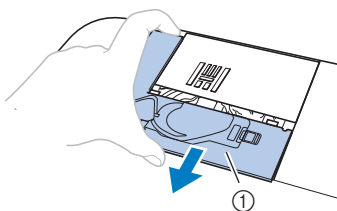

① Needle plate cover

**7** **Remove the bobbin case.**

- 1 Grasp the bobbin case, and then pull it out.

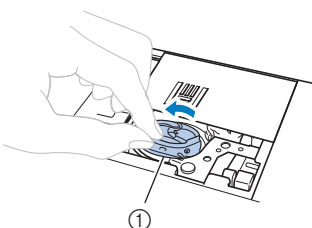

① Bobbin case

- 8** Use the cleaning brush or a vacuum cleaner to remove any lint and dust from the race and the surrounding area.

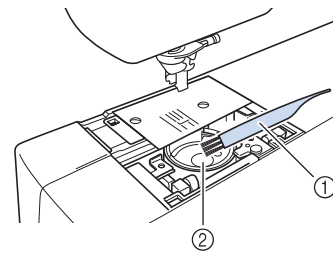

- ① Cleaning brush
- ② Race

- Do not apply oil to the bobbin case.

- 9** Insert the bobbin case so that the ▲ mark on the bobbin case aligns with the ● mark on the machine.

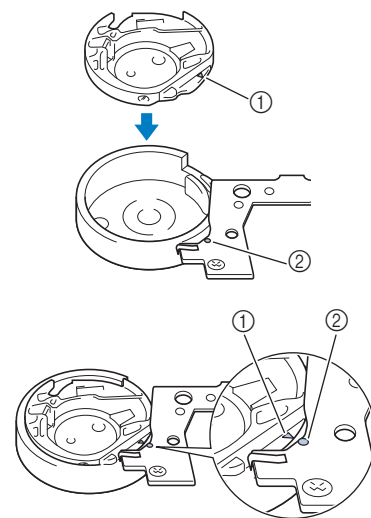

- Align the ▲ and ● marks.

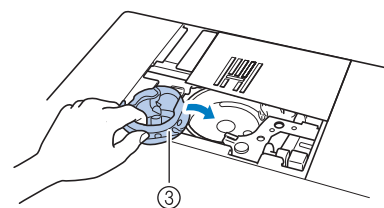

- ① ▲ mark
- ② ● mark
- ③ Bobbin case

- Make sure that the indicated points are aligned before installing the bobbin case.

- 10** Insert the tabs on the needle plate cover into the needle plate, and then slide the cover back on.

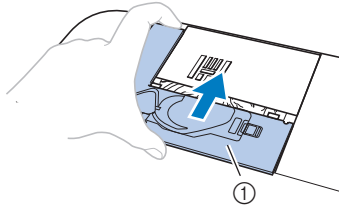

① Needle plate cover

## **⚠ CAUTION**

- Never use a bobbin case that is scratched, otherwise the upper thread may become tangled, the needle may break or sewing performance may suffer. For a new bobbin case, contact your nearest Brother authorized service center.
- Be sure that the bobbin case is correctly installed, otherwise the needle may break.

# Troubleshooting

If the machine stops operating correctly, check the following possible problems before requesting service. You can solve most problems by yourself. If you need additional help, the Brother Solutions Center offers the latest FAQs and troubleshooting tips. Visit us at "[support.brother.com](http://support.brother.com)".

If the problem persists, contact your authorized Brother dealer or the nearest Brother authorized service center.

## Frequent troubleshooting topics

Detailed causes and remedies for common troubleshooting topics are described below. Be sure to refer to this before contacting us.

Upper thread tightened up	page A-5
Tangled thread on wrong side of fabric	page A-6
Incorrect thread tension	page A-7
Fabric is caught in the machine and cannot be removed	page A-8
If the thread becomes tangled under the bobbin winder seat	page A-11
Error message "E06" appears in the LCD	page A-13

## Upper thread tightened up

### Symptom

- The upper thread appears as a single continuous line.
- The lower thread is visible from the upper side of the fabric. (Refer to the illustration below.)
- The upper thread has tightened up, and comes out when pulled.
- The upper thread has tightened up, and wrinkles appear in the fabric.
- The upper thread tension is tight, and the results do not change even after the thread tension is adjusted.

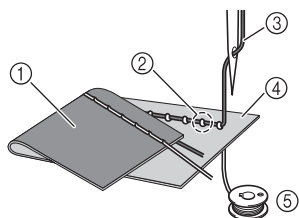

- ① Wrong side of fabric
- ② Bobbin thread visible from right side of fabric
- ③ Upper thread
- ④ Right side of fabric
- ⑤ Bobbin thread

### Cause

#### Incorrect bobbin threading

If the bobbin thread is incorrectly threaded, instead of the appropriate tension being applied to the bobbin thread, it is pulled through the fabric when the upper thread is pulled up. For this reason, the thread is visible from the right side of the fabric.

### Remedy/check details

Correctly install the bobbin thread.

- 1 Turn off the machine, and then raise the presser foot lever.
- 2 Remove the bobbin from the bobbin case.
- 3 Place the bobbin in the bobbin case so that the thread unwinds in the correct direction.

- Hold the bobbin with your right hand with the thread unwinding to the left, and hold the end of the thread with your left hand. Then, with your right hand, place the bobbin in the bobbin case.

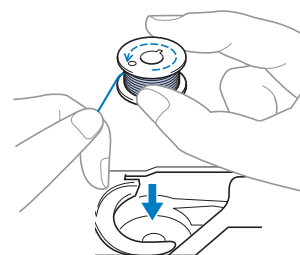

If the bobbin is inserted with the thread unwinding in the wrong direction, sewing will be done with an incorrect thread tension.

- 4 While holding the bobbin in place with your finger, pass the thread through the slit in the needle plate cover.

- Hold down the bobbin with your right hand, and then pull the end of the thread around the tab with your left hand.

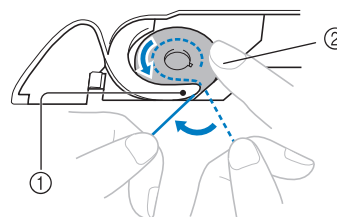

- ① Tab
- ② Hold down the bobbin with your right hand.



Pull the thread to pass it through the slit in the needle plate cover, then cut it with the cutter.

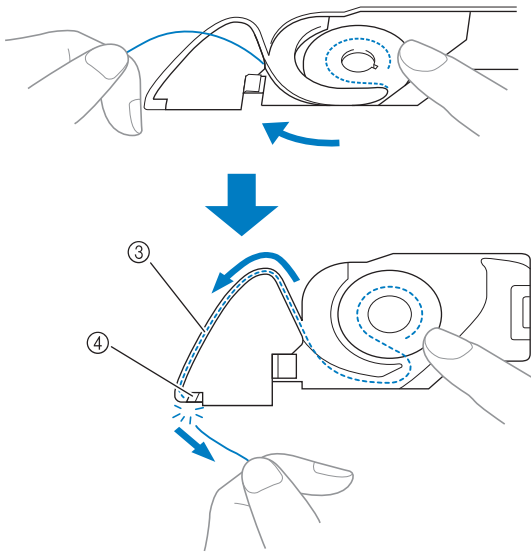

- ③ Slit
- ④ Cutter

Sewing with the correct thread tension is possible after the bobbin has been correctly installed in the bobbin case.

## Tangled thread on wrong side of fabric

### Symptom

- The thread becomes tangled on the wrong side of the fabric.

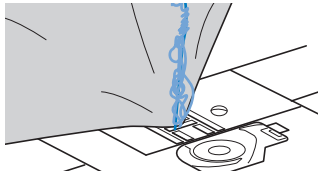

- After starting sewing, a rattling noise is made and sewing cannot continue.
- Looking under the fabric, there is tangled thread in the bobbin case.

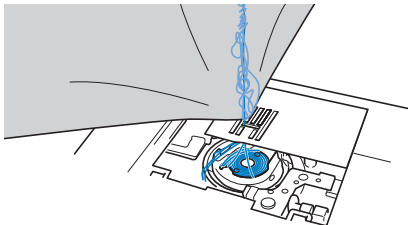

### Cause

#### Incorrect upper threading

If the upper thread is incorrectly threaded, the upper thread passed through the fabric cannot be firmly pulled up and the upper thread becomes tangled in the bobbin case, causing a rattling noise.

### Remedy/check details

Remove the tangled thread, and then correct the upper threading.

- 1 Remove the tangled thread. If it cannot be removed, cut the thread with scissors.
  - For details, refer to “Cleaning the race” on page A-2.
- 2 Remove the upper thread from the machine.
  - If the bobbin was removed from the bobbin case, refer to “Installing the bobbin” in the “Basic operations” section and “Remedy/check details” in the section “Upper thread tightened up” on page A-5 to correctly install the bobbin.
- 3 Refer to the following steps to correct the upper threading. Raise the presser foot using the presser foot lever.

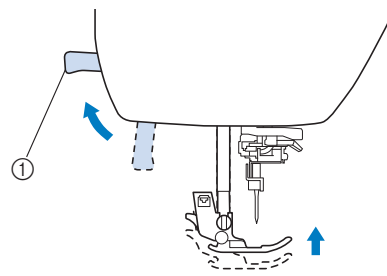

- ① Presser foot lever

→ The upper thread shutter opens so the machine can be threaded.

- If the presser foot is not raised, the machine cannot be threaded correctly.

- 4 Press  $\updownarrow$  (Needle position button) once or twice to raise the needle.

→ The needle is correctly raised when the mark on the handwheel is at the top, as shown below. Check the handwheel and, if this mark is not at this position, press  $\updownarrow$  (Needle position button) until it is.

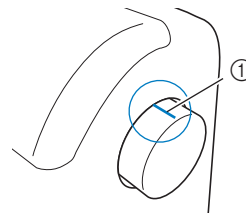

- ① Mark on handwheel

- 5 Turn off the machine.

- 6** While holding the thread lightly with your right hand, pull the thread with your left hand, and then pass the thread behind the thread guide cover and to the front.

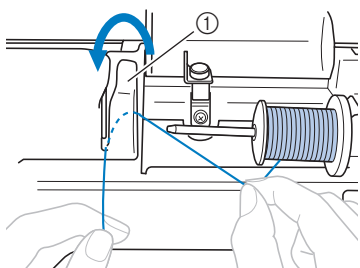

① Thread guide cover

- 7** While holding the thread lightly with your right hand, pass the thread under the thread guide plate, and then pull it up.

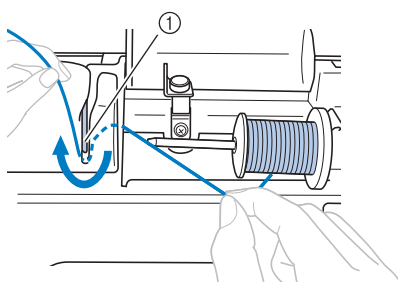

① Thread guide plate

- 8** Pass the thread through the thread channel in the order shown below.

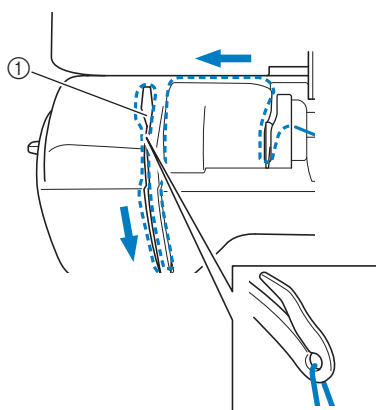

① Shutter

- 9** Lower the presser foot.

- 10** Slide the thread behind the needle bar thread guide.

The thread can easily be passed behind the needle bar thread guide by holding the thread in your left hand, then feeding the thread with your right hand, as shown. Make sure that the thread is passed through to the left of the tab of the needle bar thread guide.

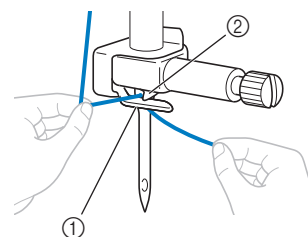

① Needle bar thread guide  
② Tab

- 11** Next, use the needle threader to thread the needle. Continue with the procedure in “Threading the needle” in the “Basic operations” section.

## Incorrect thread tension

### ■ Symptoms

- Symptom 1: The bobbin thread is visible from the right side of the fabric. (Refer to illustration below)
- Symptom 2: The upper thread appears as a straight line on the right side of the fabric.
- Symptom 3: The upper thread is visible from the wrong side of the fabric. (Refer to illustration below)
- Symptom 4: The bobbin thread appears as a straight line on the wrong side of the fabric.
- Symptom 5: The stitching on the wrong side of the fabric is loose or has slack.

### □ Symptom 1

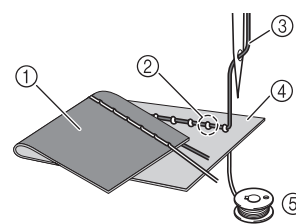

### □ Symptom 3

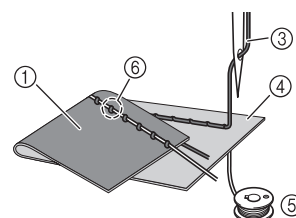

- ① Wrong side of fabric  
② Bobbin thread visible from right side of fabric  
③ Upper thread  
④ Right side of fabric  
⑤ Bobbin thread  
⑥ Upper thread visible from wrong side of fabric

■ Cause/remedy/check details

□ Cause 1

**The machine is not correctly threaded.**

<With symptoms 1 and 2 described above>

The bobbin threading is incorrect.

Return the upper thread tension to the standard setting, and then refer to “Upper thread tightened up” on page A-5 to correct the threading.

<With symptoms 3 and 5 described above>

The upper threading is incorrect.

Return the upper thread tension to the standard setting, and then refer to “Tangled thread on wrong side of fabric” on page A-6 to correct the upper threading.

□ Cause 2

**A needle and thread appropriate for the fabric are not being used.**

The machine needle that should be used depends on the type of fabric sewn and the thread thickness.

If a needle and thread appropriate for the fabric are not being used, the thread tension will not be adjusted correctly, causing wrinkles in the fabric or skipped stitches.

- Refer to “Fabric/Thread/Needle Combinations” in the “Basic operations” section to check that a needle and thread appropriate for the fabric are being used.

□ Cause 3

**An appropriate upper tension is not selected.**

The setting selected for the upper thread tension is not appropriate.

Refer to “Setting the thread tension” in the “Basic operations” section to select an appropriate thread tension.

The appropriate thread tension differs depending on the type of fabric and thread being used.

- \* Adjust the thread tension while test sewing on a piece of scrap fabric that is the same as that used in your project.



**Note**

- If the upper threading and bobbin threading are incorrect, the thread tension cannot be adjusted correctly. Check the upper threading and bobbin threading first, and then adjust the thread tension.

- **If the bobbin thread is visible from the right side of the fabric**

Turn the thread tension dial to the left to decrease the tension of the upper thread.

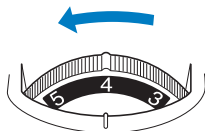

- **If the upper thread is visible from the wrong side of the fabric**

Turn the thread tension dial to the right to increase the tension of the upper thread.

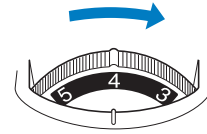

**Fabric is caught in the machine and cannot be removed**

If the fabric is caught in the machine and cannot be removed, the thread may have become tangled under the needle plate. Follow the procedure described below to remove the fabric from the machine. If the operation cannot be completed according to this procedure, instead of attempting to remove it forcefully, contact your nearest Brother authorized service center.

■ Removing the fabric from the machine

- 1 **Immediately stop the machine.**
- 2 **Turn off the machine.**
- 3 **Remove the needle.**  
If the needle is lowered into the fabric, turn the handwheel away from you (clockwise) to raise the needle out of the fabric, and then remove the needle.
  - Refer to “Replacing the needle” in the “Basic operations” section.
- 4 **Remove the presser foot and presser foot holder.**
  - Refer to “Replacing the presser foot” and “Removing and attaching the presser foot holder” in the “Basic operations” section.
- 5 **Lift up the fabric and cut the threads below it.**  
If the fabric can be removed, remove it. Continue with the following steps to clean the race.
- 6 **Remove the needle plate cover.**

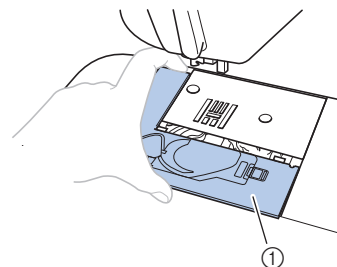

- ① Needle plate cover
- Refer to “Cleaning the race” on page A-2.

- 7** Cut out the tangled threads, and then remove the bobbin.

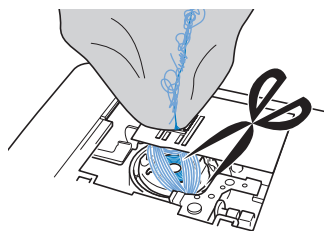

- 8** Remove the bobbin case.  
If threads remain in the bobbin case, remove them.

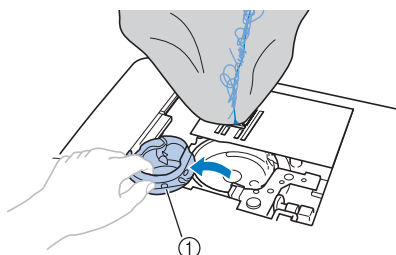

① Bobbin case

- 9** Use the cleaning brush or a vacuum cleaner mini attachment to remove any lint or dust from the race and its surrounding area.

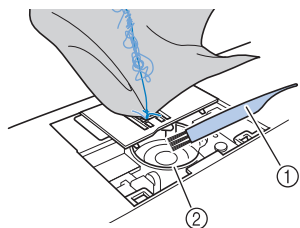

① Cleaning brush  
② Race

If the fabric could be removed.	Continue with step <b>16</b> .
If the fabric could not be removed.	Continue with step <b>10</b> .



**Note**

- Compressed can air is not recommended to be used.

- 10** Use the included disc-shaped screwdriver to loosen the two screws on the needle plate.

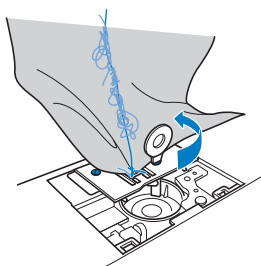

**Memo**

- (For models that include the L-shaped screwdriver)

You can also use the L-shaped screwdriver to remove the screw in the needle plate cover.

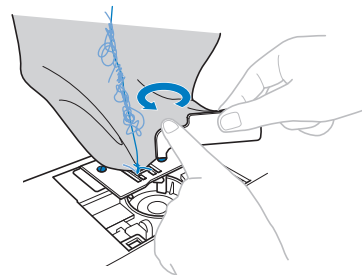

**Note**

- Be careful not to drop the removed screws in the machine.

- 11** Slightly lift up the needle plate, cut any tangled threads, and then remove the needle plate.

Remove the fabric and threads from the needle plate.

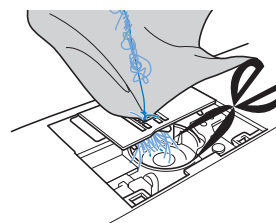

If the fabric cannot be removed, even after completing these steps, contact your nearest Brother authorized service center.

- 12** Remove any threads in the race and around the feed dogs.

- 13** Turn the handwheel to raise the feed dogs.

- 14** Align the two screw holes in the needle plate with the two holes at the needle plate mounting base, and then fit the needle plate onto the machine.

- 15** Lightly finger-tighten the screw on the right side of the needle plate. Then, use the disc-shaped (or L-shaped) screwdriver to firmly tighten the screw on the left side. Finally, firmly tighten the screw on the right side.

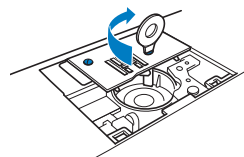



Turn the handwheel to check that the feed dogs move smoothly and do not contact the edges of the slots in the needle plate.

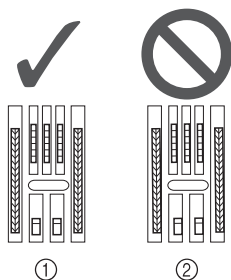

- ① Correct position of feed dogs
- ② Incorrect position of feed dogs



**Note**

- Be careful not to drop the removed screws in the machine.

- 16** Insert the bobbin case so that the ▲ mark on the bobbin case aligns with the ● mark on the machine.

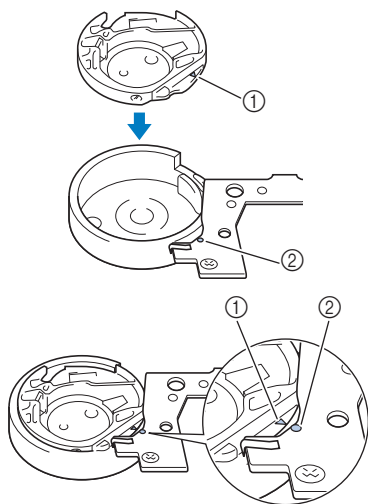

- Align the ▲ and ● marks.

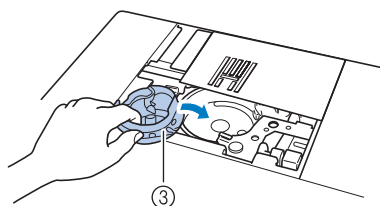

- ① ▲ mark
- ② ● mark
- ③ Bobbin case

- Make sure that the indicated points are aligned before installing the bobbin case.

## ⚠ CAUTION

- Never use a bobbin case that is scratched, otherwise the upper thread may become tangled, the needle may break or sewing performance may suffer.
- Make sure that you fit the bobbin case properly, otherwise the needle may break.

- 17** Attach the needle plate cover according to step 10 in “Cleaning the race” on page A-2.

- 18** Check the condition of the needle, and then install it.  
If the needle is in a poor condition, for example, if it is bent, be sure to install a new needle.

- Refer to “Checking the needle” and “Replacing the needle” in the “Basic operations” section.

## ⚠ CAUTION

- Never use bent needles. Bent needles can easily break, possibly resulting in injuries.



**Note**

- After completing this procedure, continue with the following procedure in “Checking machine operations” to check that the machine is operating correctly.



**Memo**

- Since the needle may have been damaged when the fabric was caught in the machine, we recommend replacing it with a new one.

### ■ Checking machine operations

If the needle plate has been removed, check machine operations to confirm that installation has been completed correctly.

- 1** Turn on the machine.

- 2** Select stitch



**Note**

- Do not yet install the presser foot and thread.



- 3 Slowly turn the handwheel toward you (counterclockwise), and look from all sides to check that the needle falls at the center of the opening in the needle plate.

If the needle contacts the needle plate, remove the needle plate, and then install it again, starting with step 13 in "Removing the fabric from the machine" on page A-8.

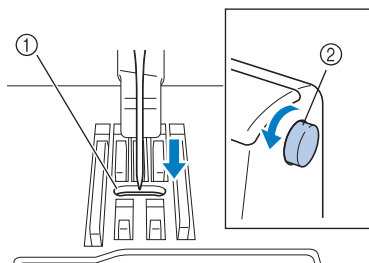

- ① Opening in the needle plate
- ② Handwheel

- 4 Select stitch . At this time, increase the stitch length and width to their maximum settings.

- For details on changing the settings, refer to "Setting the stitch width" and "Setting the stitch length" in the "Basic operations" section.

- 5 Slowly turn the handwheel toward you (counterclockwise) and check that the needle bar and feed dogs operate correctly.

If the needle or feed dogs contact the needle plate, the machine may be malfunctioning; therefore, contact your nearest Brother authorized service center.

- 6 Turn off the machine, and then install the bobbin and presser foot.

- Refer to "Installing the bobbin" and "Replacing the presser foot" in the "Basic operations" section.

- 7 Correctly thread the machine.

- For details on threading the machine, refer to "Upper Threading" in the "Basic operations" section.

#### Memo

- The thread may have become tangled as a result of incorrect upper threading. Make sure that the machine is correctly threaded.

- 8 Perform trial sewing with cotton fabric.

#### Note

- Incorrect sewing may be the result of incorrect upper threading or sewing thin fabrics. If there are poor results from the trial sewing, check the upper threading or the type of fabric being used.

### If the thread becomes tangled under the bobbin winder seat

If the bobbin winding starts when the thread is not passed under the pretension disk of the bobbin-winding thread guide correctly, the thread may become tangled under the bobbin winder seat.

In such a case, wind off the thread according to the following procedure.

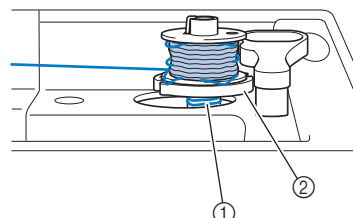

- ① Thread
- ② Bobbin winder seat

#### Memo

- The shape of the bobbin winder guide post will differ depending on your model; however, this should not affect the operating procedure. This manual describes the procedure for models with a key-shaped bobbin winder guide post.

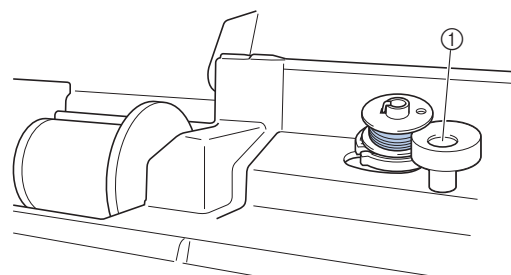

- ① Bobbin winder guide post (oval)

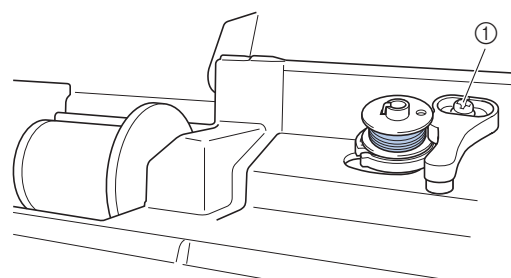

- ① Bobbin winder guide post (key)

## ⚠ CAUTION

- Do not remove the bobbin winder seat even if the thread become tangled under the bobbin winder seat. It may result in injuries.
- Do not remove the screw on the bobbin winder guide post, otherwise the machine may be damaged; you cannot wind off the thread by removing the screw.

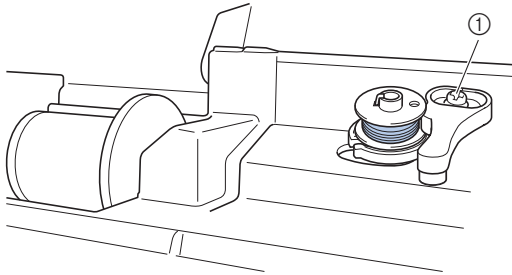

① Screw of the bobbin winder guide post

- 1 If the thread become tangled under the bobbin winder seat, press the “Start/Stop” button once to stop the bobbin winding.  
When the foot controller is plugged in, remove your foot from the foot controller.
- 2 Cut the thread with scissors beside the bobbin-winding thread guide.

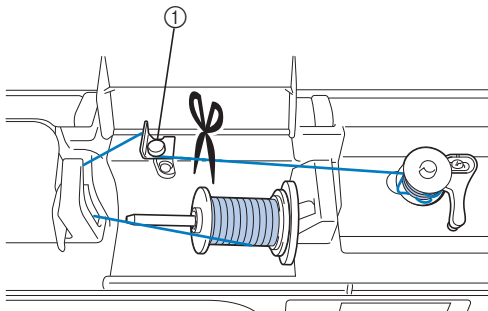

① Bobbin-winding thread guide

- 3 Slide the bobbin winder shaft to the left, and then remove the bobbin from the shaft and cut the thread leading to the bobbin in order to be able to completely remove the bobbin from shaft.

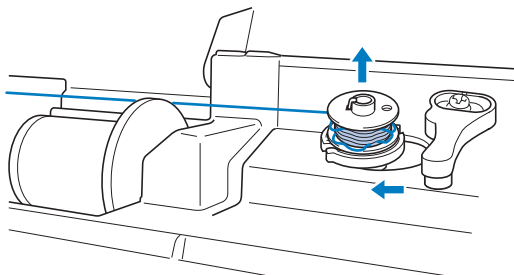

- 4 Hold the thread end with your left hand, and wind off the thread clockwise with your right hand as shown below.

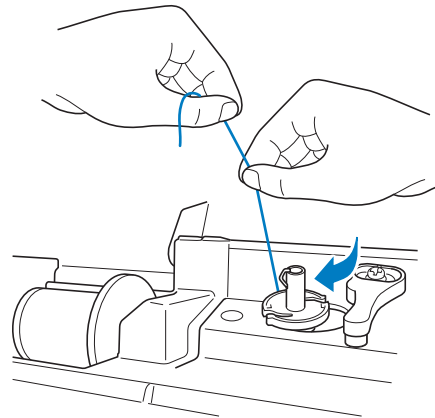

- 5 Wind the bobbin again.



### Note

- Make sure that the thread passes under the pretension disk of the bobbin-winding thread guide correctly.

## Error message “E06” appears in the LCD

If the error message “E06” appears in the LCD with the occurrence of one of the following symptoms, follow the procedure below to solve the problem.

### Symptoms

- Symptom 1: The machine rattles and then stops just after sewing is started.
- Symptom 2: The upper thread is tangled, for example, in the race, or fabric is caught in the machine.
- Symptom 3: The needle breaks, or the needle bends and thus hits the needle plate.
- Symptom 4: The fabric does not feed.

### Symptom 1: The machine rattles and then stops just after sewing is started.

#### Cause

- The upper thread is not threaded correctly.
- The thread take-up lever is not threaded.
- When the machine stops just after sewing is started, the upper thread may not be threaded correctly.



#### Note

- If the needle is not raised, the upper thread cannot be threaded correctly. Be sure to press (Needle position button) to raise the needle before threading the upper thread.

#### Remedy

Thread the upper thread again correctly by following the procedure below.

- 1 Turn off the machine.
- 2 If the thread is tangled, remove the tangled thread.
  - Refer to “Cleaning the race” on page A-2 and “Tangled thread on wrong side of fabric” on page A-6.
- 3 Remove the upper thread from the machine.
- 4 Turn the handwheel toward you (counterclockwise) to check if the handwheel moves smoothly.

If the handwheel moves smoothly	Continue with step .
If the handwheel does not move smoothly	Continue with step .

- 5 Remove the needle plate cover, and then remove the bobbin and bobbin case.
- 6 Insert the bobbin case so that the ▲ mark on the bobbin case aligns with the ● mark on the machine.
  - Refer to “Cleaning the race” on page A-2.
- 7 Attach the needle plate cover.
  - Refer to “Cleaning the race” on page A-2.

- 8 Set the bobbin in the bobbin case.
  - Refer to “Cleaning the race” on page A-2.
- 9 If the needle is bent, replace it with a new one.
  - Refer to “Replacing the needle” in the “Basic operations” section.
- 10 Turn on the machine, and then press (Needle position button) to raise the needle.
  - Refer to “Upper Threading” in the “Basic operations” section.
- 11 Thread the machine correctly.
  - For details on threading the machine, refer to “Upper Threading” in the “Basic operations” section.

### Symptom 2: The upper thread is tangled, for example, in the race, or fabric is caught in the machine.

#### Cause

Thread is tangled below the needle plate.

#### Remedy

Remove the fabric and reset the thread and bobbin by following the procedure below.

- 1 Turn off the machine.
- 2 Remove the fabric from the machine.
  - Refer to “Fabric is caught in the machine and cannot be removed” on page A-8.
- 3 Remove the upper thread and bobbin.
  - Refer to “Fabric is caught in the machine and cannot be removed” on page A-8.
- 4 Remove the bobbin case.
  - Refer to “Fabric is caught in the machine and cannot be removed” on page A-8.
- 5 If threads remain in the bobbin case, remove it.
  - Refer to “Fabric is caught in the machine and cannot be removed” on page A-8.
- 6 Insert the bobbin case so that the ▲ mark on the bobbin case aligns with the ● mark on the machine.
  - Refer to “Cleaning the race” on page A-2.
- 7 Attach the needle plate cover.
  - Refer to “Cleaning the race” on page A-2.
- 8 Set the bobbin in the bobbin case.
  - Refer to “Cleaning the race” on page A-2.
- 9 If the needle is bent, replace it with a new one.
  - Refer to “Replacing the needle” in the “Basic operations” section.
- 10 Turn on the machine, and then press (Needle position button) to raise the needle.
  - Refer to “Upper Threading” in the “Basic operations” section.



**Thread the machine correctly.**

- For details on threading the machine, refer to “Upper Threading” in the “Basic operations” section.

**■ Symptom 3: The needle breaks, or the needle bends and thus hits the needle plate.**

- Cause  
You have not used the right combination of fabric, thread and needle.
- Remedy  
Choose a thread and needle that are appropriate for the type of fabric.
  - Refer to “Fabric/Thread/Needle Combinations” in the “Basic operations” section.

**■ Symptom 4: The fabric does not feed.**

- Cause 1  
The thread has become clogged as the stitch is too fine.
- Remedy 1  
Lengthen the stitch length.
  - Refer to “Setting the stitch width” and “Setting the stitch length” in the “Basic operations” section.
- Cause 2  
Feed dog is in down position.
- Remedy 2  
Raise feed dog.
  - Refer to “Free motion quilting” in the “Sewing” section.

## List of symptoms

### ■ Getting ready

Symptom	Probable Cause	Remedy	Reference
<b>Cannot thread the needle.</b>	Needle is not in the correct position.	Press the “Needle position” button to raise the needle.	B-4
	Needle is installed incorrectly.	Reinstall the needle correctly.	B-27
	Needle is turned, bent or the point is dull.	Replace the needle.	B-27
	Upper threading is incorrect.	Check the steps for threading the machine and rethread the machine.	B-19
	The needle threader hook is bent and does not pass through the eye of the needle.	Contact your authorized Brother dealer or the nearest Brother authorized service center.	–
	The needle threader lever cannot be moved or returned to its original position.	Contact your authorized Brother dealer or the nearest Brother authorized service center.	–
	A size 65/9 needle is being used.	The needle is incompatible with the needle threader. Manually pass the thread through the eye of the needle.	B-22
<b>Bobbin thread does not wind neatly on the bobbin.</b>	The thread is not passed through the bobbin winding thread guide correctly.	Correctly pass the thread through the bobbin winding thread guide.	B-13
	Bobbin spins slowly.	Move the sewing speed controller to the right so that the speed will be increased.	B-13
	The thread that was pulled out was not wound onto the bobbin correctly.	Wind the thread that was pulled off around the bobbin 5 or 6 times clockwise.	B-13
	The empty bobbin was not set on the pin properly.	Set the empty bobbin on the pin and slowly turn the bobbin until you hear it click in place.	B-13
<b>While winding the bobbin, the bobbin thread was wound below the bobbin winder seat.</b>	You have not wound the bobbin thread properly. While initially winding thread on the bobbin the bobbin thread is not properly inserted into the guides.	After removing the thread wound below the bobbin winder seat, wind the bobbin correctly. Follow the drawn images on the top of the machine for guidance when threading the machine for bobbin winding.	B-13, A-11
<b>The bobbin thread cannot be pulled up.</b>	Needle is turned, bent or the point is dull.	Replace the needle.	B-27
	Bobbin is set incorrectly.	Reset the bobbin correctly.	B-16
<b>Nothing appears in the LCD.</b>	Main power switch is not turned on.	Turn the main power to ON.	B-10
	The plug of the power cord is not inserted into an electrical outlet.	Insert the plug of the power cord into an electrical outlet.	B-10
<b>The LCD screen is fogged up.</b>	Condensation has formed on the LCD screen.	After a while, the cloudiness will disappear.	–
<b>The operation keys do not respond.</b>	A glove is worn when the keys are pressed. The keys are pressed with a fingernail. A non-electrostatic touch pen is being used.	Directly touch the operation keys with your finger. When using a commercially available touch pen, make sure that it is compatible with capacitive sensing.	B-5
	The sensitivity of the operation keys is not set for the user.	Adjust the sensitivity of the operation keys.	B-12
<b>The sewing light does not come on.</b>	The sewing light is damaged.	Contact your authorized Brother dealer or the nearest Brother authorized service center.	–

■ While sewing

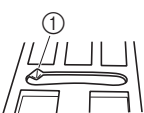
Symptom	Probable Cause	Remedy	Reference
<b>Machine does not operate.</b>	“Start/Stop” button was not pressed.	Press the “Start/Stop” button.	B-33
	The bobbin winder shaft is pushed to the right.	Move the bobbin winder shaft to the left.	B-13
	There is no pattern selected.	Select a pattern.	B-32
	Presser foot is not lowered.	Lower the presser foot.	B-33
	“Start/Stop” button was pushed with the foot controller attached.	Remove the foot controller, or use the foot controller to operate the machine.	B-34
	The “Start/Stop” button was pressed while the machine is set for the sewing speed controller to control the zigzag stitch width.	Use the foot controller instead of the “Start/Stop” button to operate the machine, or press  to turn off the width control function.	B-34
<b>Needle breaks.</b>	Needle is installed incorrectly.	Reinstall the needle correctly.	B-27
	Needle clamp screw is not tightened.	Tighten the needle clamp screw.	B-27
	Needle is turned or bent.	Replace the needle.	B-27
	Using improper needle or thread for the selected fabric.	Check the “Fabric/Thread/Needle Combinations” chart.	B-26
	Wrong presser foot was used.	Use the recommended presser foot.	B-30
	Upper thread tension is too tight.	Adjust the thread tension setting.	B-39
	Fabric is pulled during sewing.	Do not pull the fabric during sewing.	–
	Spool cap is set incorrectly.	Check the method for attaching the spool cap, then reattach the spool cap.	B-13
	There are scratches around the opening in the needle plate.  * There is a notch on the left side of the opening in the needle plate. This is not a scratch.    ① Notch	Replace the needle plate, or consult your authorized Brother dealer.	A-8
	There are scratches around the opening in the presser foot.	Replace the presser foot, or consult your authorized Brother dealer.	B-29
	There are scratches on the bobbin case.	Replace the bobbin case, or consult your authorized Brother dealer.	A-2
	Needle is defective.	Replace the needle.	B-27
	A bobbin designed specifically for this machine is not used.	Use a bobbin designed specifically for this machine.	B-13
	Upper threading is incorrect.	Check the steps for threading the machine and rethread the machine.	B-19
	Bobbin is set incorrectly.	Reset the bobbin thread correctly.	B-16
	Presser foot is attached incorrectly.	Attach the presser foot correctly.	B-29
Screw of the presser foot holder is loose.	Securely tighten the screw of the presser foot.	B-30	
Fabric is too thick.	Use fabric that the needle can pierce when the handwheel is turned.	B-26, S-4	
Fabric is fed forcefully when sewing thick fabric or thick seams.	Allow the fabric to be fed without being forcefully pushed.	S-4	

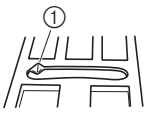
Symptom	Probable Cause	Remedy	Reference
<b>Needle breaks.</b>	Stitch length is too short.	Adjust the stitch length.	B-38
	Bobbin thread is incorrectly wound.	Use a correctly wound bobbin.	B-13
<b>Upper thread breaks.</b>	Machine is not threaded correctly (used the wrong spool cap, spool cap is loose, the thread did not catch the needle bar threader, etc.).	Rethread the machine correctly.	B-19
	Knotted or tangled thread is being used.	Remove any knots or tangles.	–
	The selected needle is not appropriate for the thread being used.	Select a needle that is appropriate for the type of thread being used.	B-26
	Upper thread tension is too tight.	Adjust the thread tension.	B-39
	Thread is tangled.	Use scissors, etc., to cut the tangled thread and remove it from the race, etc.	A-6
	Needle is turned, bent or the point is dull.	Replace the needle.	B-27
	Needle is installed incorrectly.	Reinstall the needle correctly.	B-27
	There are scratches around the opening in the needle plate.  * There is a notch on the left side of the opening in the needle plate. This is not a scratch.	Replace the needle plate, or consult your authorized Brother dealer.	A-8
	  ① Notch		
	There are scratches around the opening in the presser foot.	Replace the presser foot, or consult your authorized Brother dealer.	B-29
	There are scratches on the bobbin case.	Replace the bobbin case, or consult your authorized Brother dealer.	A-2
	Using improper needle or thread for the selected fabric.	Check the “Fabric/Thread/Needle Combinations” chart.	B-26
	While sewing, the thread became knotted or tangled.	Rethread upper and lower thread.	B-13, B-19
A bobbin designed specifically for this machine is not used.	Use a bobbin designed specifically for this machine.	B-13	
<b>The thread is tangled on the wrong side of the fabric.</b>	Upper threading is incorrect.	Check the steps for threading the machine and rethread the machine. Be sure that the presser foot is in the raised position when threading the machine so that the upper thread sets properly in the upper tension.	B-19, A-6
	Using improper needle or thread for the selected fabric.	Check the “Fabric/Thread/Needle Combinations” chart.	B-26
<b>The upper thread is too tight.</b>	The bobbin thread is incorrectly installed.	Correctly install the bobbin thread.	B-16, A-5



Symptom	Probable Cause	Remedy	Reference
<b>Bobbin thread breaks.</b>	Bobbin is set incorrectly.	Reset the bobbin correctly.	B-16
	Bobbin thread is incorrectly wound.	Use a correctly wound bobbin.	B-13
	There are scratches on the bobbin or it doesn't rotate properly.	Replace the bobbin.	B-16
	Thread is tangled.	Use scissors, etc. to cut the tangled thread and remove it from the race, etc.	A-8
	A bobbin designed specifically for this machine is not used.	Use a bobbin designed specifically for this machine.	B-13
<b>Fabric puckers.</b>	There is a mistake in the upper or bobbin threading.	Check the steps for threading the machine and rethread it correctly.	B-19
	Spool cap is set incorrectly.	Check the method for attaching the spool cap, then reattach the spool cap.	B-19
	Using improper needle or thread for the selected fabric.	Check the "Fabric/Thread/Needle Combinations" chart.	B-26
	Needle is turned, bent or the point is dull.	Replace the needle.	B-27
	Stitches are too long when sewing thin fabrics.	Shorten the stitch length.	B-38
	Thread tension is set incorrectly.	Adjust the thread tension.	B-39
	Wrong presser foot.	Use the correct presser foot.	B-30
<b>Skipped stitches</b>	Machine is threaded incorrectly.	Check the steps for threading the machine and rethread it correctly.	B-19
	Using improper needle or thread for the selected fabric.	Check the "Fabric/Thread/Needle Combinations" chart.	B-26
	Needle is turned, bent or the point is dull.	Replace the needle.	B-27
	Needle is installed incorrectly.	Reinstall the needle correctly.	B-27
	The needle is worn/damaged.	Replace the needle.	B-27
	Dust or lint has collected under the needle plate.	Remove the dust or lint with the brush.	A-2
	Thin or stretch fabrics are being sewn.	Sew with one sheet of thin paper under the fabric.	S-4, D-3
<b>No stitching</b>	Needle is turned, bent or the point is dull.	Replace the needle.	B-27
	Bobbin is set incorrectly.	Reset the bobbin thread correctly.	B-16
	Upper threading is incorrect.	Check the steps for threading the machine and rethread the machine.	B-19
<b>High-pitched sound while sewing</b>	Dust or lint is caught in the feed dogs.	Remove the dust or lint.	A-2
	Pieces of thread are caught in the race.	Clean the race.	A-2
	Upper threading is incorrect.	Check the steps for threading the machine and rethread the machine.	B-19
	A bobbin designed specifically for this machine is not used.	Use a bobbin designed specifically for this machine.	B-13
	There are needle holes or friction scratches in the bobbin case.	Replace the bobbin case, or consult your authorized Brother dealer.	A-2





Symptom	Probable Cause	Remedy	Reference
<b>Fabric does not feed through the machine.</b>	Feed dogs are set in the down position.	Slide the feed dog position switch to the right ▲▲-	B-2
	Stitches are too close together.	Lengthen the stitch length setting.	B-38
	Wrong presser foot was used.	Use the correct presser foot.	B-30
	Needle is turned, bent or the point is dull.	Replace the needle.	B-27
	Thread is entangled.	Cut the entangled thread and remove it from the race.	A-8
	Zigzag foot "J" is slanted on a thick seam at the beginning of stitching.	Use the presser foot locking pin (black button on the left side) on zigzag foot "J" to keep the presser foot level while sewing.	S-4
	Presser foot pressure is set incorrectly for fabric.	Adjust the presser foot pressure with the presser foot pressure dial.	B-41
<b>The fabric feeds in the opposite direction.</b>	The feed mechanism is damaged.	Contact your authorized Brother dealer or the nearest Brother authorized service center.	-
<b>The needle contacts the needle plate.</b>	The needle clamp screw is loose.	Firmly tighten the needle clamp screw. If the needle is bent or blunt, replace it with a new one.	B-27
	Needle is turned, bent or the point is dull.	Replace the needle.	B-27
<b>Fabric being sewn with the machine cannot be removed.</b>	Thread is tangled below the needle plate.	Lift up the fabric and cut the threads below it, and clean the race.	A-8
<b>A broken needle has fallen into the machine.</b>	-	Turn off the machine, and then remove the needle plate. If the needle that fell into the machine can be seen, use tweezers to remove it. After removing the needle, return the needle plate to its original position and insert a new needle.  Before turning on the machine, slowly turn the handwheel toward you to check that it turns smoothly and that the new needle enters through the center of the needle plate opening. If the handwheel does not turn smoothly or the needle that fell into the machine cannot be removed, contact your authorized Brother dealer or the nearest Brother authorized service center.	A-8
<b>The handwheel feels sluggish when it is turned.</b>	Thread is tangled in the bobbin case.	Remove the tangled thread from the bobbin case. Re-install the bobbin case so it is correctly positioned.	A-6, A-8
<b>The stitch is not sewn correctly.</b>	The presser foot that is used is not appropriate for the type of stitch that you wish to sew.	Attach the presser foot that is appropriate for the type of stitch that you wish to sew.	B-30
	The thread tension is incorrect.	Adjust the tension of the upper thread.	B-39, A-7
	The thread is tangled, for example, in the bobbin case.	Remove the tangle thread. If the thread is tangled in the bobbin case, clean the race.	A-8
	Feed dogs are set in the down position.	Slide the feed dog position switch to the right ▲▲-	B-2





■ After sewing

Symptom	Probable Cause	Remedy	Reference
<b>Thread tension is incorrect.</b>	Upper threading is incorrect.	Check the steps for threading the machine and rethread the machine.	B-19
	Bobbin is set incorrectly.	Reset the bobbin. (If needle plate was removed, reinstall needle plate and tighten screws prior to installing bobbin case. Check to make sure needle enter through the center of needle plate opening.)	B-16, A-2
	Using improper needle or thread for the selected fabric.	Check the "Fabric/Thread/Needle Combinations" chart.	B-26
	Presser foot holder is not attached correctly.	Reattach the presser foot holder correctly.	B-30
	Thread tension is set incorrectly.	Adjust the thread tension.	B-39, A-7
	Bobbin thread is incorrectly wound.	Use a correctly wound bobbin.	B-13
	Needle is turned, bent or the point is dull.	Replace the needle.	B-27
<b>Character or decorative patterns are misaligned.</b>	A bobbin designed specifically for this machine is not used.	Use a bobbin designed specifically for this machine.	B-13
<b>Character or decorative patterns are misaligned.</b>	Pattern adjustment settings were set incorrectly.	Revise the pattern adjustment settings.	D-7
<b>Pattern does not turn out.</b>	Wrong presser foot was used.	Attach the correct presser foot.	B-30
	Did not use a stabilizer material on thin fabrics or stretch fabrics.	Attach a stabilizer material.	S-4, D-3
	Thread tension is set incorrectly.	Adjust the thread tension.	B-39, A-7
	Fabric was pulled, pushed or fed at an angle while it was being sewn.	Sew while guiding the fabric with your hands so that the fabric is fed in a straight line.	B-33
	The thread is tangled, for example, in the bobbin case.	Remove the tangle thread. If the thread is tangled in the bobbin case, clean the race.	A-8

## Error messages

If the “Start/Stop” button is pressed before the machine is correctly set up or if an operation is performed incorrectly, an error message appears in the LCD. Follow the instructions that appear. The message will disappear if  or  is pressed while the message is displayed.



	Error Messages	Cause	Solution
1	<i>E01</i>	This message is displayed when a button, such as the “Start/Stop” button, was pressed while the presser foot was raised.	Lower the presser foot lever before continuing the operation.
2	<i>E02</i>	This message is displayed when the buttonhole lever is down, a stitch other than a buttonhole is selected, and a button, such as the “Start/Stop” button, is pressed.	Lift the buttonhole lever before continuing the operation.
3	<i>E03</i>	This message is displayed when the buttonhole lever is up, a buttonhole stitch is selected, and a button, such as the “Start/Stop” button, is pressed.	Lower the buttonhole lever before continuing the operation.
4	<i>E04</i>	This message is displayed when a button, such as the Reverse/reinforcement stitch button, was pressed while the bobbin winder shaft is moved to the right.	Move the bobbin winder shaft to the left before continuing the operation.
5	<i>E05</i>	This message is displayed when the “Start/Stop” button was pressed while the foot controller was connected.	Disconnect the foot controller, and then press the “Start/Stop” button. Otherwise, operate the machine by using the foot controller.
6	<i>E06</i>	The motor locked up because the thread became tangled, or the needle bent and thus hit the needle plate.	Clean the race to remove the tangled thread (refer to page A-2). Check the needle. If the needle is bent or broken, replace the needle. For details, refer to “Checking the needle” and “Replacing the needle” in the “Basic operations” section. If both of the above fail, refer to “Error message “E06” appears in the LCD” on page A-13.
7	<i>E07</i>	This message is displayed when a button, such as the “Start/Stop” button, was pressed after a stitch has been deleted.	Select a pattern before continuing the operation.
8	<i>E08</i>	This message is displayed when the “Start/Stop” button is pressed while the machine is set for the stitch width control.	To turn width control function off, press the width control key  so that  on the operation panel disappears and the “Start/Stop” button can then be used. (S-32)
9	<i>E09</i>	This message is displayed when  (Twin needle) is turned on, and a stitch pattern that cannot be sewn with the twin needle is selected.	Switch to the single needle mode, and replace the twin needle with a single needle before continuing the operation.
10	<i>E10</i>	This message is displayed when you try to sew with a stitch other than a straight stitch (middle needle position) while the straight stitch needle plate is installed.	Turn off the machine, and then replace the needle plate before continuing the operation.
11	<i>E11</i>	This message is displayed when the needle plate cover is removed while the machine is still turned on.	Turn off the machine, and then attach the needle plate cover before continuing the operation.
12	<i>F**</i>	If error message “F**” appears in the LCD while the machine is being used, the machine may be malfunctioning.	Contact your nearest Brother authorized service center.

## Operation beep

Each time a key is pressed you will hear one beep. If an incorrect operation is performed you will hear two or four beeps.

- **If a key is pressed (correct operation)**  
One beep sounds.
- **If an incorrect operation is performed**  
Two or four beeps sound.
- **If the machine locks up, for example, because the thread is tangled**  
The machine beeps for four seconds and the machine automatically stops.  
Be sure to check for the cause of the error and correct it before continuing to sew.

### ■ Canceling the operation beep

- 1 Turn off the machine.
- 2 While pressing  (Reinforcement stitch button) on the operation panel, turn on the sewing machine.
- 3 Press the “-” or “+” key to select “ 2”.

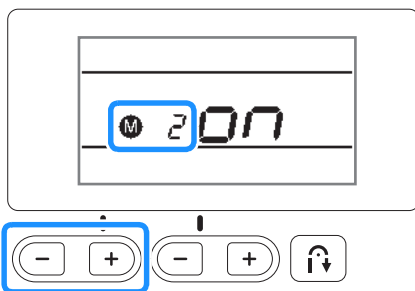

- 4 Press the “-” or “+” key to set to “OFF”.

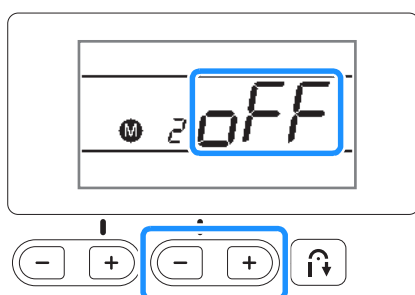

- 5 Turn off the machine, then turn it on again.

# Index

## Numerics

1/4" quilting foot .....	S-29
1/4" quilting foot with guide .....	S-29
7 mm satin stitches .....	D-2

## A

Accessories	
included accessories .....	B-7
optional accessories .....	B-8
Accessory compartment .....	B-6
Adjustable zipper/piping foot .....	S-24
Adjusting stitch length .....	B-38
Adjusting stitch width .....	B-38
Adjusting thread tension .....	B-39
Air vent .....	B-3
Appliqué .....	S-27
Attaching presser foot holder .....	B-30
Automatic reinforcement stitch key .....	B-35
Automatic thread cutting .....	B-40

## B

Ball point needle .....	B-26
Bar tack stitch .....	S-33
Basic sewing .....	B-31, D-4
Basic stitching .....	S-6
Basting stitch .....	S-6
Beep .....	A-22
Blind hem stitch .....	S-8
Bobbin case .....	B-4
bobbin case removal .....	A-2
Bobbin cover .....	B-4, B-16
Bobbin installation .....	B-16
Bobbin thread	
pulling up .....	B-23
winding .....	B-13
Bobbin winder .....	B-2
Bobbin winding .....	B-13
Bobbin winding thread guide .....	B-2, B-13
Button guide plate .....	S-15
Button sewing .....	S-17
Buttonhole lever .....	B-4, S-16
Buttonhole sewing .....	S-14
Buttonhole stitching .....	S-14

## C

Changing sewing direction .....	S-2
Character stitches .....	B-32, D-2
Checking needle .....	B-27
Cleaning	
cleaning machine surface .....	A-2
LCD screen .....	A-2
race .....	A-2
Combining patterns .....	D-5
Concealed seams .....	S-20
Crazy quilt stitching .....	S-28
Curve sewing .....	S-2
Cutting thread automatically .....	B-40
Cylindrical pieces .....	S-2

## D

Darning .....	S-34
Darning stitch .....	S-33
Decorative stitches & patterns .....	D-2
Drawnwork .....	S-40

## E

Error messages .....	A-21
Even seam allowance .....	S-3
Eyelet stitching .....	S-36

## F

Fagoting .....	S-37
Feed dog position switch .....	B-3, S-31
Feed dogs .....	B-4
Flat bed attachment .....	B-2, B-6
Foot controller .....	B-3, B-34
Foot controller jack .....	B-3, B-34
Fraying, preventing .....	S-11
Free motion quilting .....	S-31
free motion open toe quilting foot "O" .....	S-31
Front view .....	B-2

## H

Handle .....	B-3
Handwheel .....	B-3
Heirloom stitching .....	S-40
Horizontal spool pin .....	B-23

## I

Input sensitivity .....	B-12
Inserting a piping .....	S-25
Installing bobbin .....	B-16

## J

Joining .....	S-39
---------------	------

## L

LCD messages .....	A-21
LCD operation .....	B-11
LCD screen	
cleaning .....	A-2
Leather/vinyl fabrics .....	S-5

## M

Machine surface cleaning .....	A-2
Main power switch .....	B-3, B-10
Maintenance .....	A-2
Manual needle threading .....	B-22

## N

Needle	
condition .....	B-27
position .....	S-7
replacement .....	B-27
threading .....	B-21
types, sizes & uses .....	B-26
Needle bar thread guide .....	B-4
Needle plate .....	B-4
Needle plate cover .....	B-4
Needle plate marking .....	S-3
Needle position button .....	B-4
Needle threader .....	B-21
Needle threader lever .....	B-2, B-21
Non stick foot .....	S-5

A

MAINTENANCE AND TROUBLESHOOTING

- O**
- Operation beep ..... A-22
  - Operation buttons ..... B-4
  - Operation keys ..... B-5
  - Operation panel ..... B-2, B-5
  - Operation problems ..... A-5
  - Optional accessories ..... B-8
  - Overcasting stitches ..... S-11, S-12
- P**
- Pant legs ..... S-2
  - Parallel stitches ..... B-23
  - Part names & functions ..... B-2
  - Patchwork ..... S-27, S-28
  - Pattern
    - check ..... D-6
    - combination ..... D-5
    - realignment ..... D-7
    - recalling ..... D-7
    - repetition ..... D-6
    - storage ..... D-6
  - Piecing ..... S-28
  - Piping inserting ..... S-25
  - Power supply jack ..... B-3, B-10
  - Power switch ..... B-3, B-10
  - Presser foot
    - pressure ..... B-41
    - replacement ..... B-29
    - types ..... B-42
  - Presser foot holder
    - installation ..... B-30
    - removal ..... B-30
  - Presser foot holder screw ..... B-4
  - Presser foot lever ..... B-3
  - Presser foot pressure dial ..... B-3, B-41
  - Pretension disk ..... B-2, B-15, A-11
- Q**
- Quilting ..... S-30
  - Quilting guide ..... S-31
- R**
- Race ..... A-2
  - Realigning pattern ..... D-7
  - Recalling pattern ..... D-7
  - Reinforcement priority ..... B-37
  - Reinforcement stitch button ..... B-4, B-35
  - Reinforcement stitching ..... S-33
  - Removing presser foot holder ..... B-30
  - Repeating patterns ..... D-6
  - Replacing needle ..... B-27
  - Replacing presser foot ..... B-29
  - Reverse stitch button ..... B-4, B-35
  - Reverse/Reinforcement stitches ..... B-35
- S**
- Satin stitches ..... D-2
  - Satin stitching ..... S-32
  - Scallop stitching ..... S-38
  - Seam allowance, even ..... S-3
  - Seam ripper ..... S-16
  - Settings
    - automatic reinforcement stitching ..... B-35
    - beep ..... A-22
    - input sensitivity ..... B-12
  - Sewing basics ..... B-31
  - Sewing direction change ..... S-2
  - Sewing speed controller ..... B-4, S-32
  - Shell tuck stitch ..... S-39
  - Side cutter ..... S-12
  - Smocking ..... S-38
  - Solving operation problems ..... A-5
  - Spool cap ..... B-2, B-14
  - Spool net ..... B-14
  - Spool pin ..... B-2, B-14, B-20
  - “Start/Stop” button ..... B-4
  - Stippling ..... S-27
  - Stitch guide foot ..... S-3
  - Stitch length adjustment ..... B-38
  - Stitch selection ..... B-32
  - Stitch settings ..... B-42
  - Stitch types ..... B-31
  - Stitch width adjustment ..... B-38
  - Storing patterns ..... D-6
  - Straight stitch ..... S-6, S-20, S-28
  - Stretch fabrics ..... S-5
- T**
- Thick fabrics ..... S-4
  - Thin fabrics ..... S-4
  - Thread cutter ..... B-2, B-34
  - Thread cutter button ..... B-4
  - Thread cutting, automatic ..... B-40
  - Thread guide plate ..... B-2
  - Thread tension adjustment ..... B-39
  - Thread tension dial ..... B-2
  - Threading
    - threading needle ..... B-21
    - threading needle manually ..... B-22
    - upper threading ..... B-19
  - Tips ..... S-2
  - Top cover ..... B-2
  - Trial sewing ..... S-2
  - Triple stretch stitch ..... S-6, S-33
  - Troubleshooting ..... A-5
  - Twin needle ..... B-23
- U**
- Upper thread ..... B-19
  - Upper thread tension ..... B-39, A-7
  - Utility stitches ..... B-32, B-42
- W**
- Walking foot ..... S-30
  - Winding bobbin ..... B-13
  - Wing needle ..... S-40
- Z**
- Zigzag stitches ..... S-12, S-27
  - Zigzag width adjustment ..... B-38
  - Zipper insertion
    - centered ..... S-20, S-24
    - side ..... S-21













Please visit us at [support.brother.com](http://support.brother.com) where you can get product support and answers to frequently asked questions (FAQs).

English  
888-F00/F10/H32  
Printed in Vietnam



XG5450-301③