



b77



User Manual

bernette

SWISS DESIGN

Table of Contents

IMPORTANT SAFETY INSTRUCTIONS	6	Changing the Presser Foot	29
Important Information	9	Having the presser foot sole displayed in the user interface	30
1 My bernette	11	Setting the Presser Foot Pressure	31
1.1 Overview Machine	11	2.8 Needle and Stitch Plate	31
Overview front controls	11	Changing the Needle	31
Overview front	14	Selecting the Needle in the User Interface	32
Overview Top	15	Needle Stop Up/Down (Permanent)	32
Overview back	15	Changing the Stitch Plate	32
1.2 Accessory	16	Checking the Stitch Plate in the User Interface	33
Included accessories	16	2.9 Threading	34
Overview presser feet	17	Preparing the Threading	34
1.3 Overview User Interface	18	Threading the Upper Thread	34
Overview System Settings	18	Threading the Twin Needle	37
Overview Functions/Visual Information	18	Winding the Bobbin Thread	39
Overview Functions and Views	18	Threading the Bobbin Thread	41
1.4 Needle, Thread, Fabric	19	3 Setup Program	43
Overview Needles	19	3.1 Sewing Settings	43
Example for Needle Description	22	Adjusting the Upper Thread Tension	43
Thread Selection	22	Adjusting the Maximum Sewing Speed	43
Needle/Thread Combination	22	Programming Securing Stitches	43
2 Sewing Preparation	23	Adjusting the Hovering Height of the Presser Foot	44
2.1 Connection and Switching On	23	Programming the Button «Securing»	44
Connecting the Machine	23	Programming the Button «Thread Cutter»	45
Use of the Power Cable (only USA/Canada)	23	Adjusting the Presser Foot Position with Needle Stop Down	45
Connecting the Foot Control	23	Programming the Button «Quick Reverse»	46
Attaching the Knee Lifter of the Free Hand System	24	Programming the "Needle Up/Down" Button	46
Switching the Machine On	24	Programming the Foot Control Individually	47
Fixing the Touch Screen Pen	25	Fabric Thickness Measurement	47
Regulating the Speed via the Foot Control	25	Adjusting the General Balance	48
Raising/Lowering the Needle	25	3.2 Selecting Personal Settings	48
Programming the Foot Control Individually	25	3.3 Monitoring Functions	48
2.2 Spool Pin	25	Activating the Upper Thread Indicator	48
Horizontal Spool Pin	25	Activating the Bobbin Thread Indicator	49
Second Spool Pin	26	3.4 Sound On/Off	49
2.3 Freearm	27	3.5 Machine Settings	49
2.4 Sewing Table and Accessory Box	27	Adjusting the Brightness of the Display	49
2.5 Raising or Lowering the Feed Dog	28	Adjusting the Sewing Light	49
2.6 Using the Slide-on Table	28	Calibrating the Display	50
2.7 Presser Foot	29	Back to basic settings	50
Adjusting the Presser Foot Position via the Knee Lifter of the Free Hand System	29	Checking the Firmware Version	50
		Reviewing the Total Number of Stitches	51

4	System Settings	52	6.5	Sewing Triple Straight Stitch	69
4.1	Using eco Mode	52	6.6	Sewing Triple Zigzag	69
4.2	Calling up the Creative Consultant	52	6.7	Manual Darning	70
4.3	Cancelling Any Alterations with «clr»	53	6.8	Reinforced Darning, Automatic	70
5	Creative Sewing	54	6.9	Finishing Edges	72
5.1	Overview Selection Menu Sewing	54	6.10	Sewing Double Overlock	73
	Selecting a Stitch Pattern	54	6.11	Sewing Vari Overlock	73
5.2	Dual feed	55	6.12	Edgestitching Using the Seam Guide	73
	Application of the Dual Feed	55	6.13	Sewing a Narrow Hem	74
	Use the Dual Feed	55	6.14	Sewing Blind Hems	75
5.3	Regulating the Speed	56	6.15	Sewing Visible Hems	76
5.4	Adjusting the Upper Thread Tension	56	6.16	Sewing Basting Stitches	76
5.5	Editing Stitch Patterns	56	6.17	Sew Thick Areas	76
	Changing the Stitch Width	56	6.18	Sewing Corners	77
	Changing the Stitch Length	57	7	Decorative Stitches	78
	Correcting the Balance	57	7.1	Overview Decorative Stitches	78
	Programming Pattern Repeat	58	7.2	Altering the Stitch Density	79
	Mirror Image of Stitch Patterns	58	7.3	Sewing Cross Stitches	79
	Edit Stitch Pattern Length	58	8	Alphabets	80
	Permanent Quick Reverse	59	8.1	Overview Alphabet	80
	Backstepping	59	8.2	Creating Lettering	80
5.6	Combining Stitch Patterns	60	9	Buttonholes	82
	Overview Combi Mode	60	9.1	Overview Buttonholes	82
	Creating Stitch Pattern Combinations	60	9.2	Marking Buttonholes	83
	Editing a Single Stitch Pattern	60	9.3	Sewing a Buttonhole Automatically	84
	Deleting a Single Stitch Pattern	61	9.4	Reinforce Buttonhole	86
	Adding a Single Stitch Pattern	61	9.5	Sewing On Buttons	87
	Mirroring a Stitch Pattern Combination	62	9.6	Sewing Eyelets	88
	Programming Pattern Repeat	62	10	Quilting	89
	Securing a Stitch Pattern Combination	62	10.1	Overview Quilt Stitches	89
	Saving a Stitch Pattern Combination	63	10.2	Quilting, Securing Program	90
	Loading a Stitch Pattern Combination	63	10.3	Sewing Hand-look Quilt Stitches	90
	Overwriting a Stitch Pattern Combination	63	10.4	Guiding the Quilt Work Freely	91
	Deleting a Stitch Pattern Combination	63	11	Maintenance and Cleaning	92
5.7	Administering Stitch Patterns	64	11.1	Cleaning and Maintenance Intervals	92
	Saving Stitch Patterns in Personal Memory	64	11.2	Cleaning the Display	92
	Overwriting Stitch Patterns from the Personal Memory	64	11.3	Cleaning the Feed Dog	92
	Loading Stitch Patterns from the Personal Memory	64			
	Deleting Stitch Patterns from the Personal Memory	64			
6	Practical Stitches	65			
6.1	Overview Practical Stitches	65			
6.2	Sewing Straight Stitch	67			
6.3	Securing with the Automatic Securing Program	67			
6.4	Sewing in the Zipper	68			

11.4	Cleaning the Hook	93
11.5	Oiling the Needle Bar	94
12	Errors and Faults	95
12.1	Troubleshooting	95
12.2	Error messages	97
13	Technical data	100
14	Appendix	101
14.1	Overview Stitch Patterns	101
	Practical Stitches	101
	Buttonholes	101
	Decorative stitches	101
	Quilt Stitches	103
	Index	104

IMPORTANT SAFETY INSTRUCTIONS

Please be aware of the following basic safety instructions when using your machine. Before using this machine, read instruction manual carefully.

DANGER

To protect against electric shock, the following instructions must be observed.

- Never leave the machine unattended when it is connected to the power supply.
- Immediately after use and before cleaning, switch off the machine and disconnect the power cable from the outlet.

In order to protect against injury, the following instructions must be adhered to.

- Do not look directly into the LED lamp with optical instruments (e. g. magnifying glass).
- If the LED lamp is damaged or defective, have the LED lamp checked or repaired at your local authorized bernette dealer.
- Switch off the machine before working in the needle area.
- Before starting the machine, close all covers.

WARNING

To reduce the risk of burns, fire, electric shock or injury to persons, the following instructions must be observed.

General Facts

- This machine may only be used for the purpose described in this instruction manual.

Working Environment

- Do not use the machine outdoors.
- Only use the machine in dry rooms.
- Do not use the machine in a humid area.
- Do not use the machine in rooms where aerosol products (sprays) are being used.
- Do not use the machine in rooms where oxygen is dispensed.

Technical Condition

- Never use the machine when it is damp.
- Do not use the machine if it is not working properly.

- Do not use the machine if a cable or the plug is damaged.
- Do not use the machine if it has been dropped, damaged or has fallen into water.
- If the machine is damaged or does not work properly, have the machine checked or repaired by your local authorized bernette dealer.
- Keep all ventilation openings of the machine and the foot control free of lint, dust and loose cloth.
- Do not use the machine if the ventilation openings are blocked.

Accessories and Supplies

- Only use the accessories recommended by the manufacturer.
- Always use the original bernette Stitch Plate.
An incorrect stitch plate can result in needle breakage.
- Use only straight needles of good quality.
Bent or damaged needles can cause needle breakage.
- This machine is double-insulated (except for USA, Canada and Japan).
Use only identical replacement parts. See instructions for Servicing of double-insulated products.
- To lubricate the machine, only use oil recommended by bernette.

Safety Instructions

- While operating the machine, all protective inserts must be in place and all covers must be closed.

Appropriate Use

- The machine may be used, cleaned and maintained by children older than eight or by people with reduced physical, sensory or mental capabilities or if there is a lack of experience and knowledge as long as they have been given instructions.
- Furthermore, these persons must be supervised while working with the machine, and/or they must know the safe operation of the machine and be aware of the resulting hazards.
- Children are not allowed to play with the system.
- Special care should be taken when the machine is operated by or in the presence of children.
- Only use the machine with the supplied power cable.
- USA and Canada only: Do not connect power plug NEMA 1-15 to circuits exceeding 150 volt-to-ground.
- Only use this machine with the supplied foot control of type FC-210.
- Do not insert any objects into the openings of the machine.

- Do not place any objects on the foot control.
- While sewing, guide the fabric gently. Pulling and pushing the fabric can cause needle breakage.
- Keep fingers away from all moving parts.
- Special care is required in the needle area.
- For activities in the needle area - such as threading the needle, changing the needle, threading the looper or changing the presser foot - switch off the machine.
- To switch off, set the power switch to «0».
- When protective covers are removed, when the machine is oiled or when other cleaning and maintenance operations mentioned in this instruction manual are carried out, switch off the machine and disconnect the power plug from the outlet.
- Pull the plug out of the outlet by pulling on the plug. Do not pull on the cable.

Important Information

Availability of the Instruction Manual

The short manual is part of the machine.

- Keep the short manual of the machine in a suitable place near the machine and have it ready for reference.
- The latest version of the detailed instruction manual can be downloaded at www.bernette.com.
- When passing on the machine to a third party, enclose the short manual of the machine.

Proper Use

Your bernette machine is conceived and designed for private household use. It is intended for sewing fabrics and other materials as described in this instruction manual. Any other use is not considered proper. BERNINA assumes no liability for consequences resulting from improper use.


Equipment and Scope of Delivery

Example images are used in these instructions for the purposes of illustration. The machines shown in the images and the accessories shown therefore do not always match the actual items included with your machine. The supplied accessory can vary depending on the country of delivery. You can acquire any accessories mentioned or shown that are not included in the scope of delivery as optional accessories from a specialist bernette dealer. Further accessories can be found at www.bernette.com.

For technical reasons and in order to improve the product, changes may be made to the equipment of the machine and the scope of delivery at any time and without prior notice.

Servicing of Double-insulated Products

In a double-insulated product two systems of insulation are provided instead of grounding. No grounding means is provided on a double-insulated product nor should a means for grounded be added to the product. Servicing a double-insulated product requires extreme care and knowledge of the system and should only be done by qualified service personnel. Replacement parts for a double-insulated product must be identical to the original parts in the product. A double insulated product is marked with the words: «Double-Insulation» or «double-insulated».

 The symbol may also be marked on the product.

Environmental Protection

BERNINA International AG is committed to environmental protection. We strive to minimize the environmental impact of our products by continuously improving product design and our technology of manufacturing.



The machine is labeled with the symbol of the crossed-out wastebin. This means that the machine should not be disposed of in household waste when it is no longer needed. Improper disposal can result in dangerous substances getting into the groundwater and thus into our food chain, damaging our health.

The machine must be returned free of charge to a nearby collection point for waste electrical and electronic equipment or to a collection point for the reuse of the machine. Information on the collection points can be obtained from your local administration. When purchasing a new machine, the dealer is obliged to take back the old machine free of charge and dispose of it properly.

If the machine contains personal data, you are responsible for deleting the data yourself before returning the machine.

Explanation of Symbols

 **DANGER**

Designates a danger with a high risk which can lead to serious injuries or even death unless it is avoided.

 **WARNING**

Designates a medium-risk hazard which can lead to serious injuries if not avoided.

 **CAUTION**

Designates a low-risk hazard which can lead to minor or moderate injuries if not avoided.

NOTICE

Designates a hazard which can lead to material damage if not avoided.

1 My bernette






1.1 Overview Machine


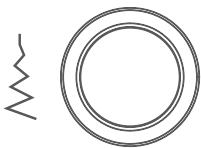
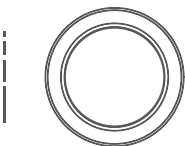
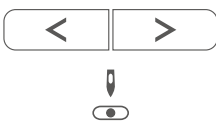
Overview front controls



- | | | | |
|---|----------------------|---|---------------------------|
| 1 | Quick Reverse | 6 | Needle Up/Down |
| 2 | Thread Cutter | 7 | Upper Multi-function Knob |
| 3 | Presser Foot Up/Down | 8 | Lower Multi-function Knob |
| 4 | Start/Stop | 9 | Needle Left/Right |
| 5 | Securing Stitches | | |

Operating Components

Number	Operating Component	Name	Purpose
1		Quick Reverse	<ul style="list-style-type: none"> > To sew backward, press the «Quick Reverse» button. > To sew backward permanently, keep the «Quick Reverse» button pressed. <p>The «Quick Reverse» button does not work for stitch patterns 22–24 and for buttonhole patterns 51–71.</p>
2		Thread Cutter	<ul style="list-style-type: none"> > To cut the upper thread and the lower thread automatically, press the «Thread Cutter» button. <p>2-6 securing stitches can be programmed in the Setup-Program. They are sewn before the thread is cut.</p>
3		Presser Foot Up/Down	<ul style="list-style-type: none"> > Press the «Presser Foot Up/Down» button to raise the presser foot into a hovering position. > Press the button «Presser Foot Up/Down » to raise the presser foot.
4		Start/Stop	<p>The button «Start/Stop» is used to change the presser foot position and to start the machine.</p> <ul style="list-style-type: none"> > To start the machine, keep the button «Start/Stop» pressed for 2 seconds. > Press the button «Presser Foot Up/Down» briefly to raise the presser foot into hovering position.
5		Needle Up/Down	<ul style="list-style-type: none"> > Push the button «Needle Up/Down» to lower the needle. > Push the «Needle Up/Down» button again to raise the needle.

Number	Operating Component	Name	Purpose
6		Securing Stitches	<p>The function «Securing at Sewing Start» is activated in the Setup by default and can be deactivated by pressing the button «Securing».</p> <p>When the function «Securing at Sewing Start» is not activated in the Setup, it can be programmed by pressing the button «Securing».</p> <p>A securing icon which appears on the display during sewing indicates that the function is activated.</p> <p>The number of securing stitches can be programmed in the Setup-Program.</p> <ul style="list-style-type: none"> > To sew the securing stitches first, press the button «Securing» before you start sewing. > To sew the securing stitches at the pattern end, press the button «Securing» while sewing. > To sew securing stitches within a stitch pattern combination, press the button «Securing». <ul style="list-style-type: none"> – The selected pattern of the combination is secured according to the setting.
7		Upper Multi-function Knob	Settings can be changed with the «Upper Multifunctional knob» and the Lower Multifunctional knob.
8		Lower Multi-function Knob	Settings can be changed with the «Lower Multifunctional knob» and the Lower Multifunctional knob.
9		Needle Left/Right	<p>There is a total of 15 needle positions. The needle position is indicated by the needle position number in the display.</p> <ul style="list-style-type: none"> > Press the «Needle Left» button to move the needle to the left. > Press the «Needle Right» button to move the needle to the right.

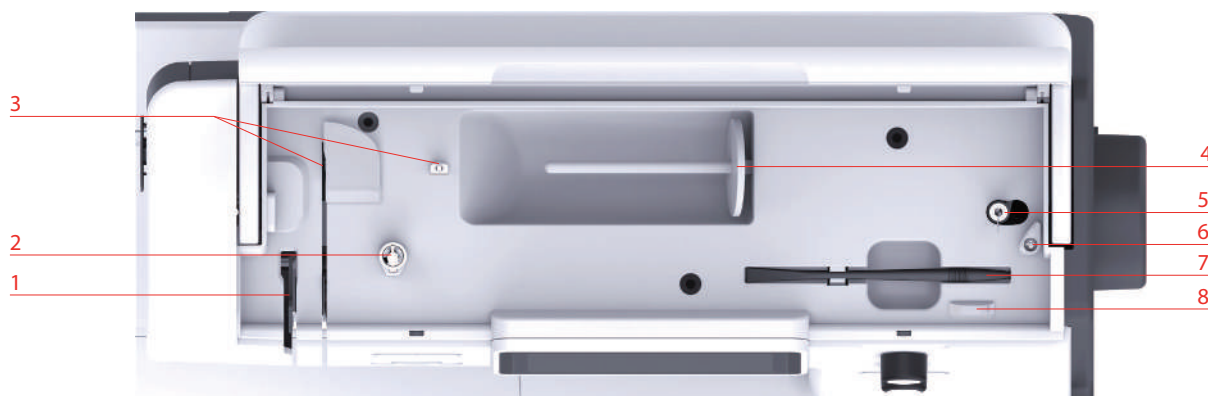
Overview front



- | | | | |
|---|--------------------|----|---------------------------------|
| 1 | Feed dog lever | 8 | Thread cutter |
| 2 | Stitch plate cover | 9 | Slide speed control |
| 3 | Stitch plate | 10 | Thread take-up lever |
| 4 | Presser foot | 11 | Top cover |
| 5 | Sewing light | 12 | LCD Display |
| 6 | Needle threader | 13 | Connection for Free Hand System |
| 7 | Buttonhole lever | 14 | Sewing table and accessory box |

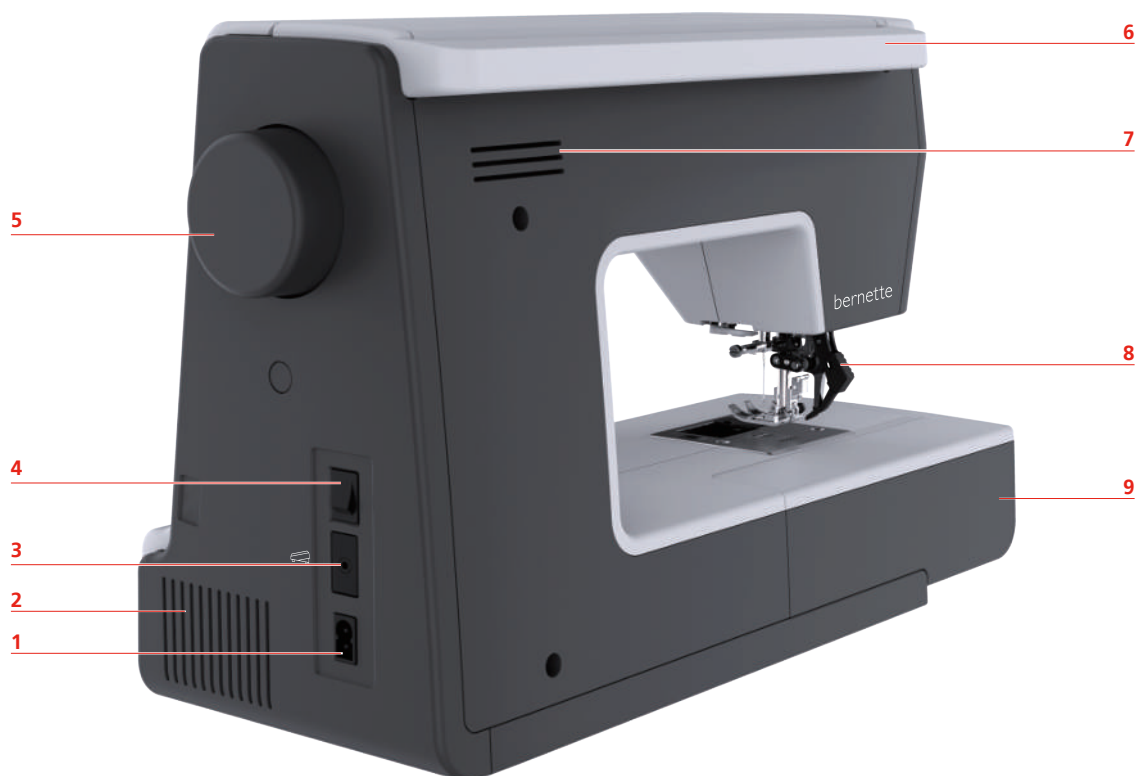


Overview Top



- | | | | |
|---|--------------------------|---|--|
| 1 | Thread Take-up Lever | 5 | Winding Unit and Holder for Second Spool Pin |
| 2 | Bobbin Winder Pretension | 6 | Stopper Winding Unit |
| 3 | Thread Guide | 7 | Touchscreen Pen |
| 4 | Spool Pin | 8 | Thread Cutter |

Overview back




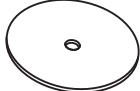

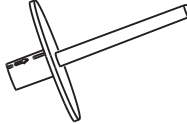
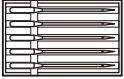

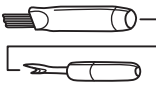
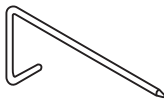



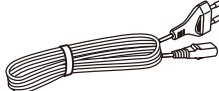

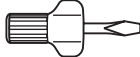
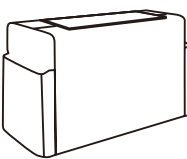
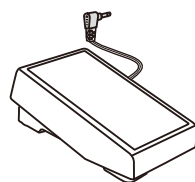
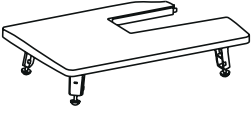
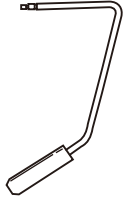
- | | | | |
|---|-----------------------------|---|--------------------------------|
| 1 | Connection for power cable | 6 | Carrying handle |
| 2 | Air vents | 7 | Air vents |
| 3 | Connection for foot control | 8 | Dual Feed (DF) |
| 4 | Power switch | 9 | Sewing table and accessory box |
| 5 | Handwheel | | |

1.2 Accessory




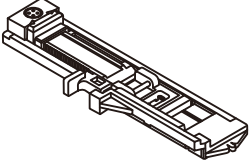
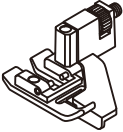

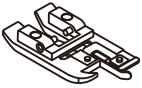
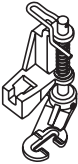
Included accessories

Visit www.mybernette.com/accessories for more accessory information.



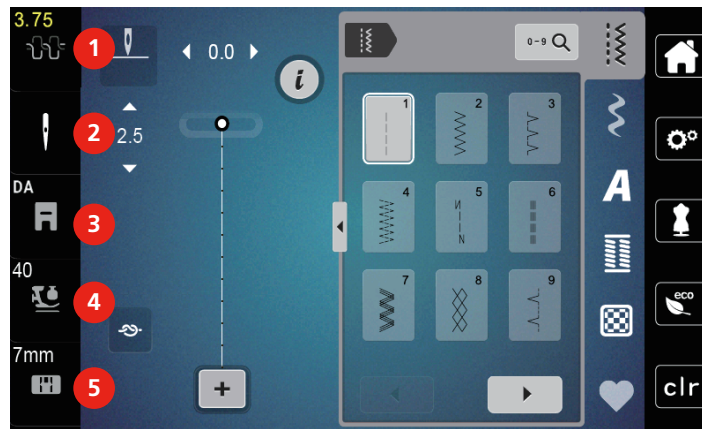
Illustration	Name	Illustration	Name
	Bobbin (3x)		Felt disc
	Spool net		Second spool pin
	Selection of needles		Touchscreen pen
	Brush/ Seam ripper		Seam guide
	Spool disc large		Lubricator
	Spool disc middle (1x)		Power cable
	Spool disc small		Screwdriver
	Dust cover		Foot control
	Slide-on table		Free Hand System

Overview presser feet

Illustration	Name	Purpose
	Zigzag Foot (DA)	For sewing different practical, decorative stitches and hems with Dual Feed.
	Embroidery Foot (JK)	For sewing satin stitches, applications and decorative patterns.
	Zipper Foot (JB)	For sewing with Dual Feed. For sewing in the zipper.
	Buttonhole Foot with Slide (RJ)	For sewing buttonholes.
	Blindstitch Foot (DM)	For sewing blind-stitch hems with Dual Feed.
	Button Sew-On Foot (RC)	For sewing on buttons.
	Overlock Foot (DI)	For sewing with Dual Feed. For sewing overlock stitches over the fabric edge.
	Free-motion Embroidery Foot (RX)	For embroidering, darning and freehand quilting.

1.3 Overview User Interface

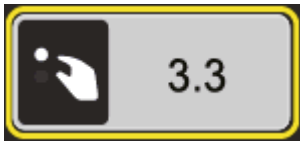
Overview Functions/Visual Information



- | | | | |
|---|---|---|------------------------|
| 1 | Upper Thread Tension | 4 | Foot Pressure |
| 2 | Needle Selection | 5 | Stitch Plate Selection |
| 3 | Presser Foot Display/Presser Foot Selection | | |

Overview Functions and Views

Illustration	Name	Purpose
	Close	The display is closed and the previously made adjustments are saved.
	«Plus» / «Minus»	Change setting values.
	Confirm	Confirms the previously adjusted alterations. The display is closed.
	Cancel	The process is canceled. The display is closed and the previously made adjustments are not saved.
	Slide	By moving the slide the setting values are changed.
	Switch	Activates or deactivates functions.
	USB Storage Space	The percentage of used USB storage (%) will be displayed in the green bar icon.

Illustration	Name	Purpose
	Yellow-framed Icon	Tap the yellow-framed icon to reset the changes to the default setting.

1.4 Needle, Thread, Fabric

Needles will wear down over time. Therefore, the needle should be replaced regularly. Only a perfect point results in a good stitching result. In general, the thinner the fabric, the finer the needle. ☒The illustrated needles are either standard or optional accessory, depending on the machine.

- Needle sizes 70, 75: for light-weight fabrics.
- Needle sizes 80, 90: for medium fabrics.
- Needle sizes 100: for heavy fabrics.

Overview Needles

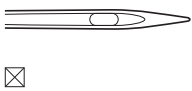
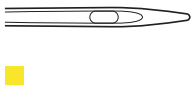
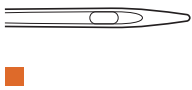
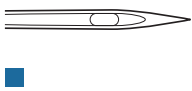
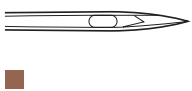
Illustration	Needle Name	Needle Description	Purpose
	Universal Needle 130/705 H 60-110	Slightly rounded point.	For nearly all natural and synthetic fabrics (woven and knitted).
	Stretch Needle 130/705 H-S 75/11 – 90/14	With a medium ball point.	For knitwear (jersey, tricot, knit and stretch material). For general sewing, sewing on buttons and buttonholes, zippers, hems and topstitching, decorative sewing, embroidery.
	Jersey/ Embroidery Needle 130/705 H SUK 80/12	With a medium ball point.	For woven fabrics (light, medium, heavy-weight), knitwear, plastic. For general sewing, sewing on buttons and buttonholes, zippers, hems and topstitching, decorative sewing, embroidery.
	Jeans Needle 130/705 H-J 80/12 – 110/18	With slim, particularly acute point.	Woven fabrics (light, medium, heavy-weight), leather, jeans/denim. For general sewing, sewing on buttons and buttonholes, zippers, hems and topstitching, decorative sewing, embroidery, patchwork, quilting.
	Leather Needle Leather Needle 90/14, 100/16	With a cutting point (LR = special point to sew leather).	For leather, imitation leather and other similar materials. For zippers, hems and topstitching, materials that tend to stick.



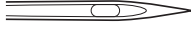















Illustration	Needle Name	Needle Description	Purpose
 	Microtex Needle 130/705 H-M 60/8 – 110/18	With a particularly pointed and slender tip.	For woven fabrics (light, medium, heavy), artificial materials and materials that are difficult to work with. For silk, microfibre fabrics, foils, coated and hard-sliding materials. For sewing in general, sewing on buttons and buttonholes, zips, hems and topstitching and decorative sewing. For ultra straight stitches when topstitching edges.
 	Quilting Needle 130/705 H-Q 75/11 – 90/14	With a very slim, slightly rounded point.	For woven fabrics (light, medium and heavy-weight). Decorative sewing, patchwork, quilting. For stitching/topstitching tasks, such as quilting and patchwork.
 	Embroidery Needle 130/705 H-E 75/11 – 90/14	With a light ball point and a particularly wide eye and wide groove.	For woven fabrics (light, medium, heavy-weight), knitwear. For voluminous and woolen threads. For general sewing, sewing on buttons and buttonholes, zippers, hems and topstitching, decorative sewing, embroidery.
 	Fine Fabrics Needle 130/705 H SES 70/10 – 90/14	With a light ball point.	For fine, delicate materials, such as velvet. For general sewing, sewing on buttons and buttonholes, zippers, hems and topstitching, decorative sewing, embroidery, patchwork, quilting.
 	Metafil Needle 130/705 H METAFIL 80/12	With medium ball point and long eye (2 mm).	For woven fabrics (light, medium, heavy-weight), knitwear. For sewing with special effects and fancy threads, especially metallic threads. For embroidery with metallic thread. For hems and topstitching, decorative sewing and embroidery.
 	Topstitch Needle 130/705 H-N 80/12 – 100/16	With medium ball point and long eye (2 mm).	For woven fabrics (light, medium and heavy-weight). For hems and topstitching, decorative sewing and embroidery. For decorative and quilting work with several sewing threads and also for embroidery.

Illustration	Needle Name	Needle Description	Purpose
 <input checked="" type="checkbox"/>	Hemstitch Needle 130/705 H WING 100–110	Wing-like widened needle shaft (wing)	To sew blind stitches.
 <input checked="" type="checkbox"/>	Universal Twin Needle 130/705 H ZWI 70-100	Needle distance: 1.0/1.6/2.0/2.5/3.0 /4.0/6.0/8.0	For visible hems in stretch fabrics, pintucks, decorative sewing.
 <input checked="" type="checkbox"/>	Stretch Twin Needle 130/705 H-S ZWI 75	Needle distance: 2.5/4.0	For visible hems in stretch fabrics, pintucks, decorative sewing.
 <input checked="" type="checkbox"/>	Hemstitch Twin Needle 130/705 H ZWIHO 100	Needle distance: 2.5	For special effects with hemstitch embroidery.
 <input checked="" type="checkbox"/>	Universal Triple Needle 130/705 H DRI 80	Needle distance: 3.0	For visible hems in stretch fabrics, decorative sewing.

Example for Needle Description

The 130/705 system, which is the most common for household machines, is explained by the following picture of a Jersey/Stretch needle.

	<p>130/705 H-S/70</p> <p>130 = Shank length (1)</p> <p>705 = Flat shank (2)</p> <p>H = Needle scarf (3)</p> <p>S = Needle point (here medium ball point) (4)</p> <p>70 = Needle size 0.7 mm (5)</p>
---	---

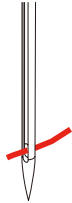


Thread Selection

For a perfect sewing result, thread and fabric quality play an important role.

We recommend purchasing quality threads to achieve good sewing results.

- Cotton threads have the advantage of being a natural fiber and therefore are especially suitable for sewing cotton fabrics.
- Mercerized cotton threads have a slight sheen that is not lost with washing.
- Polyester threads have a high tensile strength and is particularly colorfast.
- Polyester threads are more flexible and are recommended where a strong and elastic seam is required.
- Rayon threads are made of natural fibers and have a brilliant sheen.
- Rayon threads are suitable for decorative stitches and achieve a more beautiful effect.

Needle/Thread Combination

	<p>The needle/thread combination is correct, when the thread fits perfectly into the long groove and goes easily through the needle eye. The thread can be optimally sewn.</p>
	<p>The thread can break and skipped stitches can occur when there is too much clearance in the long groove and the needle eye.</p>
	<p>The thread can break and get stuck when the thread scrapes against the edge of the long groove not fit well into the needle eye optimally.</p>

2 Sewing Preparation

2.1 Connection and Switching On

Connecting the Machine

To ensure safe operation of the machine, only the supplied mains cable may be used. The supplied power cable is designed for the voltage range applicable in the country of use. If the machine is to be used in a country other than the country of origin, the power cable suitable for that country must be obtained from the Authorized bernette dealer.

The power cable for the USA and Canada has a polarized power plug (one contact is wider than the other). To reduce the risk of an electric shock, the plug can only be inserted into the socket in one way. If the power plug does not fit in the socket, reverse then insert the power plug. If the reversed power plug still does not fit, an electrician must install an appropriate socket. Do not modify the power plug in any way.

- > Insert the device connector of the power cable into the machine's power cable connection.



- > Insert the power plug of the power cable into the socket.

Use of the Power Cable (only USA/Canada)

The machine has a polarized plug (one contact is wider than the other). To reduce the risk of electric shock, the plug can only be plugged into the socket in one way. If the plug does not fit into the socket, turn the plug. If it still does not fit, an electrician needs to be called to install an appropriate outlet. Do not modify the plug in any way.

Connecting the Foot Control

The cable of the foot control is rolled up on its underside.

- > Unroll the cable of the foot control to the desired length and fix it in the cable holders of the foot control.



- > Insert the plug of the cable into the foot control socket of the machine.



- > Place the foot control under the table.
- > If the cable is too long, roll up the excess length and fix it in the cable holders of the foot control.

Attaching the Knee Lifter of the Free Hand System

The presser foot may be raised and lowered with the Free Hand System. The knee lifter is extremely helpful when sewing appliqué, patchwork and quilting since it allows you to handle the fabric while your knee controls the presser foot.

- > Insert the knee lifter into the opening at the front side of the machine.
- > Adjust the sitting height so that the knee lifter can be operated with the knee.



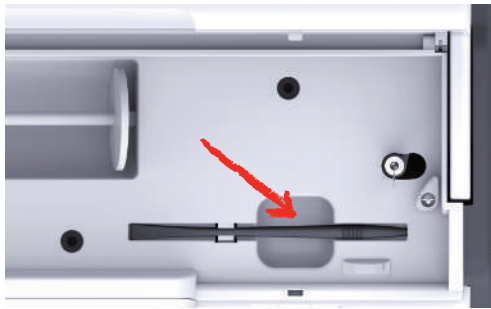
Switching the Machine On

- > Set the power switch to «I».



Fixing the Touch Screen Pen

- > Store the touchscreen pen on the top holder.



Regulating the Speed via the Foot Control

Via the foot control the speed can be adjusted infinitely variable.

- > Press the foot control down carefully to start the machine.
- > To sew more quickly, press the foot control further down.
- > Release the foot control to stop the machine.



Raising/Lowering the Needle

- > Sink the heel back on the foot control to raise/lower the needle.



Programming the Foot Control Individually

The foot control can be programmed individually.

2.2 Spool Pin

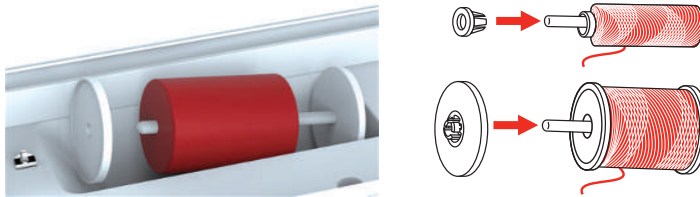
Horizontal Spool Pin

Placing the Thread Spool and the Spool Cap

Spool caps hold the thread spool in place for proper release of thread from the spool.

- > Place the thread spool on the spool pin.

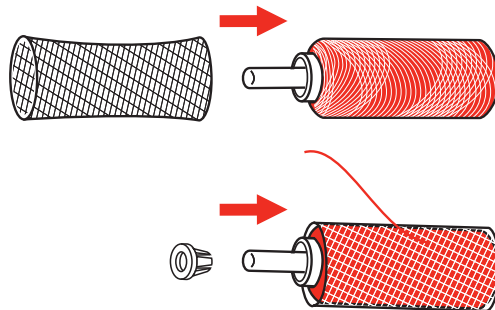
- > Position the appropriate spool cap on the spool pin so that there is no space between the spool cap and the thread spool.



Using the Spool Net

The spool net holds the thread on the thread spool and prevents the thread from knotting and breaking. The spool net is only used with the horizontal spool holder.

- > Pull the spool net over the thread spool. Ensure when doing so that the spool net does not slip off the thread spool, e.g. double-insert the net over the thread spools or insert a part of the net into the thread spool at the rear.

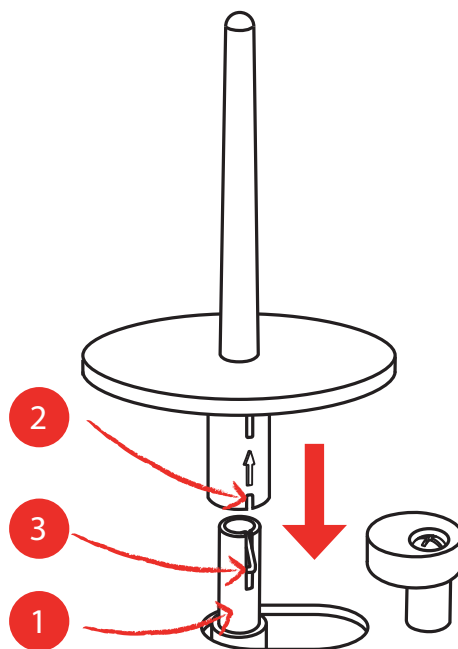


Second Spool Pin

Installing the Second Spool Pin

The second spool pin is necessary when several threads are sewn.

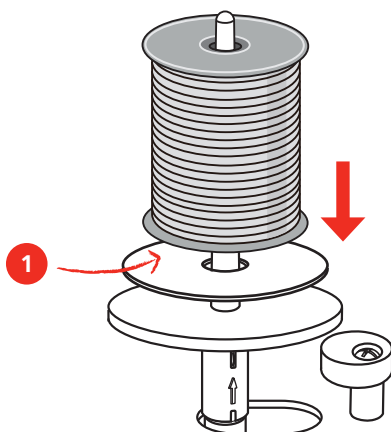
- > Insert the second spool pin onto the end of the bobbin winding unit (1).
- > Align the notch (2) with the spring (3) on the bobbin winding unit.



Inserting Thread Spool

The felt disc prevents the thread from sticking to the spool pin.

- > Place the felt disc (1) on the second spool pin.
- > Place the thread spool on the second spool pin.



2.3 Freearm

The bernette b77 provides a solidly freearm which offers a lot of space for large project on the right of the needle.

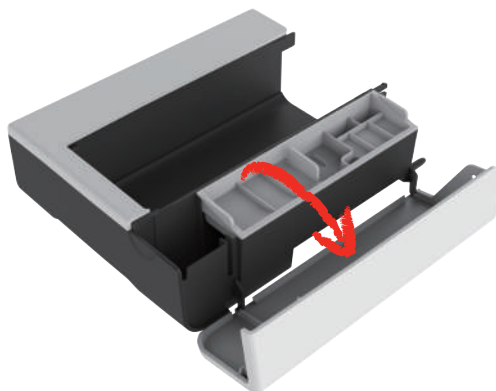
2.4 Sewing Table and Accessory Box

The sewing table is used as an accessory box.

- > To remove the sewing table, hold the sewing table by the handle on the left and pull in the direction of the arrow.



- > To open the accessory box, tilt the cover towards you.
- > To close the accessory box, tilt the cover backwards until it clicks into place.



2.5 Raising or Lowering the Feed Dog



- > To raise the feed dog, push the feed dog lever to the right.
 - The feed dog is raised when the first stitch is sewn.
- > Slide the «Feed Dog Lever» left to lower the feed dog.
 - The feed dog is lowered.

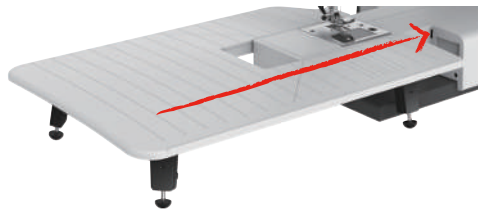
2.6 Using the Slide-on Table

The Slide-on Freearm Extension Table, attached to the freearm, enables the available sewing area to be extended.

The height of the extension table can be adjusted by turning the adjustable feet.

Prerequisite:

- The sewing table is removed.
- > Raise the needle.
- > Raise the presser foot.
- > Switch off the machine.
- > Unfold the feet on the extension table.
- > Push the Slide-on Freearm Extension Table from the left to the right over the freearm until it engages.



- > To remove the slide-on table, pull the slide-on table over the freearm to the left.



2.7 Presser Foot

Adjusting the Presser Foot Position via the Knee Lifter of the Free Hand System

- > Adjust the sitting height so that the knee lifter can be operated with the knee.
- > Move the knee lifter with the knee to the right to raise the presser foot.

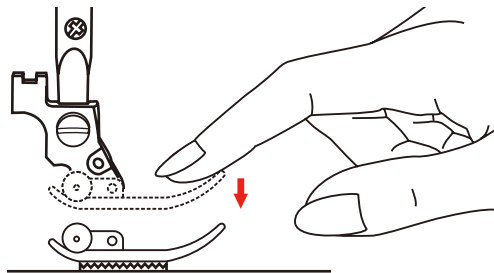


- Simultaneously the thread tension is released.
- > Release the knee lifter slowly to lower the presser foot.

Changing the Presser Foot

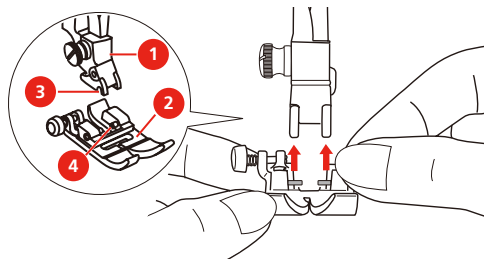
Removing the Presser Foot Sole

- > Raise the presser foot.
- > With the finger press the front edge of the presser foot.



Attaching the Presser Foot Sole

- > Raise the presser foot (1).
- > Place the presser foot sole (2) under the shaft groove (3) so that the shaft groove is above the presser foot sole pin (4).
- > Then push the new presser foot sole upward until it engages.

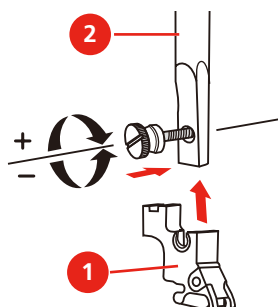


Removing and Inserting the Presser Foot Holder

Prerequisite:

- The presser foot sole is removed.
- > Raise the presser foot.

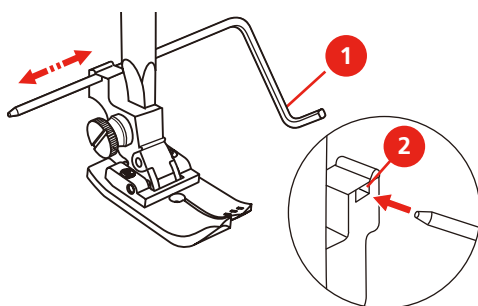
- > Align the presser foot holder (1) with the presser foot bar (2) underneath and to the left.
- > Hold the presser foot holder firmly and screw in the screw by hand.
- > Tighten the screw using the screwdriver.



Attaching the Seam Guide

The seam guide is suitable for sewing parallel lines.

- > Insert the seam guide (1) in the slot (2).
- > Set the required distance to the adjacent seam.



Having the presser foot sole displayed in the user interface

The recommended presser foot sole for the selected stitch is displayed. Moreover, other optimal presser foot soles can be displayed.

- > Switch the machine on.
- > Select a stitch pattern.
 - The recommended presser foot sole with letter designation is displayed in the «Presser Foot Indicator/Presser Foot Selection» field.

A

- > Tap «Presser Foot Indicator/Presser Foot Selection».
- Any presser foot soles are displayed.



- A green tick indicates the recommended presser foot sole.
- A yellow star indicates the presser foot soles which can also be used for this stitch for special purposes.

Setting the Presser Foot Pressure



The presser foot pressure is designed to adjust the pressure of the presser foot optimally to the fabric thickness. When working with thick fabrics, it is recommended to reduce the presser foot pressure. This provides the advantage that the fabric can be moved more easily. When the presser foot pressure is set below 0, the presser foot even lifts to give more space to the thick fabric. When working with thin fabrics, it is recommended to increase the presser foot pressure. This provides the advantage that the fabric cannot be moved too easily under the presser foot.

40

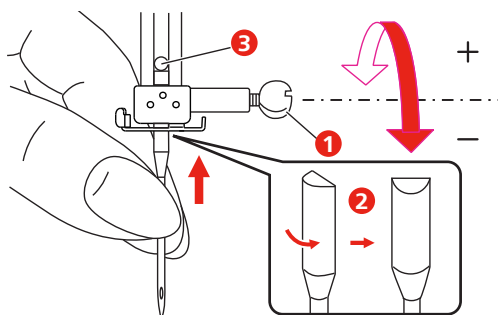


- > Tap «Presser Foot Pressure».
- > Adjust the presser foot pressure.

2.8 Needle and Stitch Plate

Changing the Needle

- > Raise the presser foot.
- > Raise the needle.
- > Switch the machine off and disconnect it from the power supply system.
- > Loosen the fixing screw (1) with the screwdriver.
- > Pull the needle down to remove.
- > Hold the new needle (2) with the flat side to the rear. Push the needle upwards into the needle holder as far as it will go (3).
- > Tighten the fixing screw with the screwdriver.

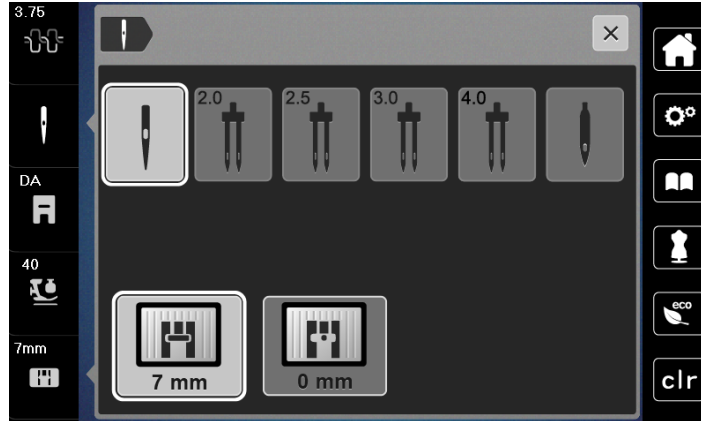


Selecting the Needle in the User Interface

After changing the needle, you can check whether it can be used with the selected stitch plate.



- > Tap «Needle Selection» or «Stitch Plate/Needle Selection».
- > Select the attached needle.



- When the selected needle matches the selected stitch plate and the presser foot, sewing can be started.
- If the selected needle does not match with the stitch plate, a red exclamation mark will appear on the display.

Needle Stop Up/Down (Permanent)

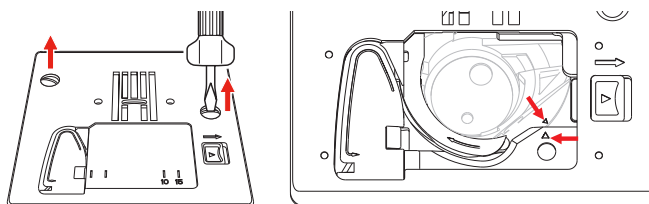
- > To set the needle stop position permanently, tap «Needle Stop Up/Down».
 - The machine stops with needle position down as soon as the foot control is released or the button «Start/Stop» has been pushed.
- > Tap «Needle Stop Up/Down» again.
 - The machine stops with needle position up as soon as the foot control is released or the button «Start/Stop» has been pushed.

Changing the Stitch Plate

The stitch plate is marked with vertical, horizontal and diagonal lines in millimeters (mm) and inches (inch). These markings are helpful for sewing or precise top-stitching. **Please Note:** The markings of the bobbin case and the stitch plate must be aligned identically.

Prerequisite:

- The feed dog is lowered.
 - The machine is switched off and disconnected from the power supply system.
 - The bobbin cover, the needle and the presser foot are removed.
- > Remove the screws of the stitch plate with the screwdriver.



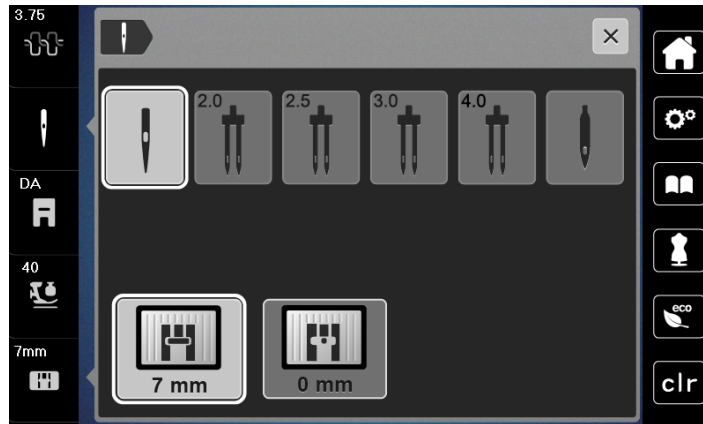
- > Remove the stitch plate.
- > Position new stitch plate and tighten screws with screwdriver.

Checking the Stitch Plate in the User Interface

After changing the stitch plate, you can check whether it can be used with the selected needle.



- > Tap «Stitch Plate/Needle Selection».
 - The mounted stitch plate is automatically detected and shown in the display.



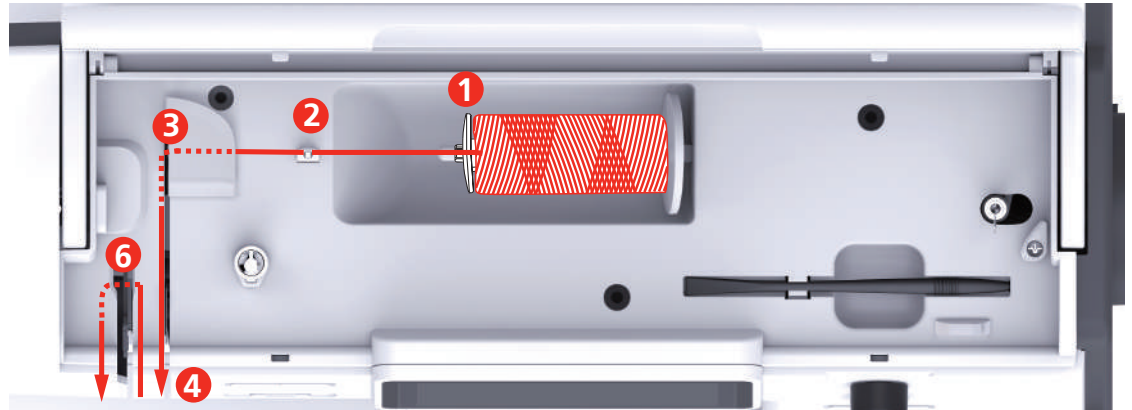
- If the selected stitch plate is suitable to be used in combination with the needle, sewing can begin.
- The stitch width is automatically set to the permissible value.
- If the selected needle does not match with the stitch plate, a red exclamation mark will appear on the display.

2.9 Threading

Preparing the Threading

- > Press the button «Presser Foot Up/Down » to raise the presser foot.
- > Raise the presser foot.

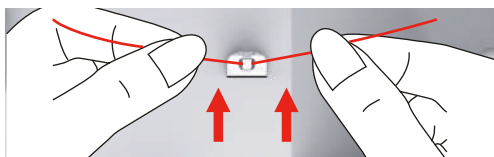
Threading the Upper Thread



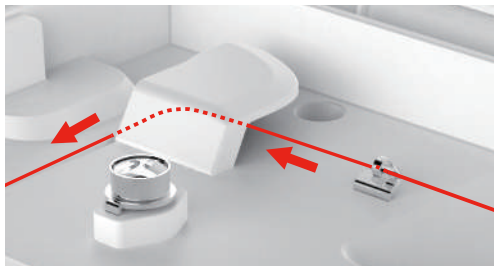
- | | | | |
|---|----------------------------|----|---------------|
| 1 | Spool Cap | 7 | Guide |
| 2 | Thread Guide | 8 | Guide |
| 3 | Thread Pretension | 9 | Thread Lever |
| 4 | Thread Tensions Discs | 10 | Wire Hook |
| 5 | Thread Take-up Lever Cover | 11 | Thread Cutter |
| 6 | Thread Take-up Lever | 12 | Thread |

- > Place the thread spool on the spool pin so that the thread unwinds clockwise.
- > Fit the spool cap suitable for the spool.

- > Feed the thread through the thread guide.



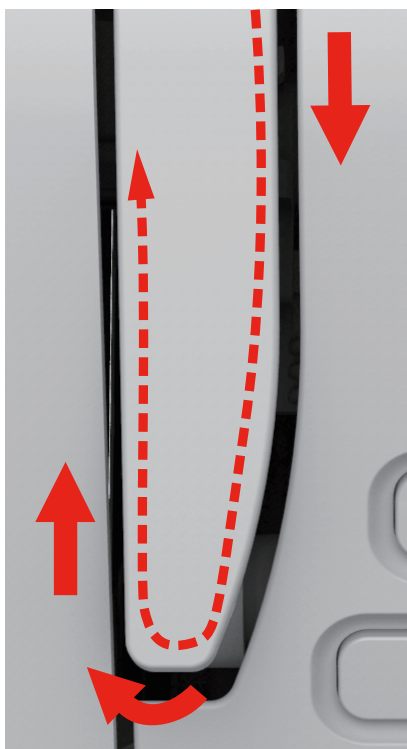
- > Guide the thread through the thread pretension.



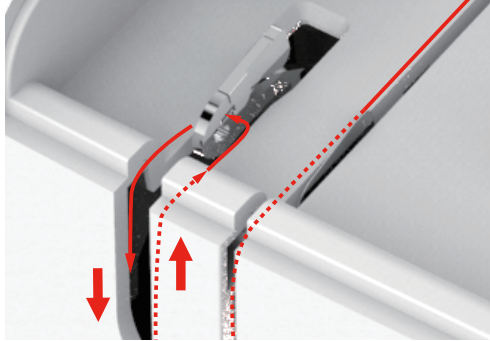
- > Place the end of the thread down along the duct.



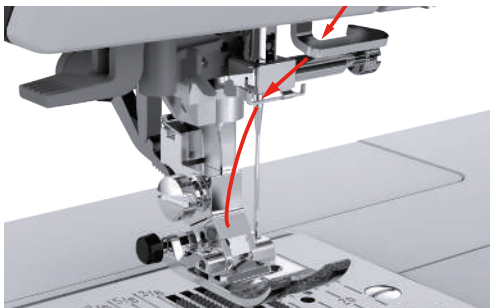
- > Guide the thread downwards around the thread take-up lever cover.



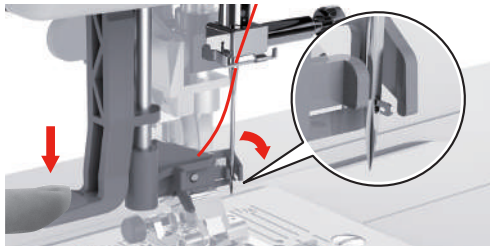
- > Guide the thread at the top from right to the left through the thread take-up lever and then down again.



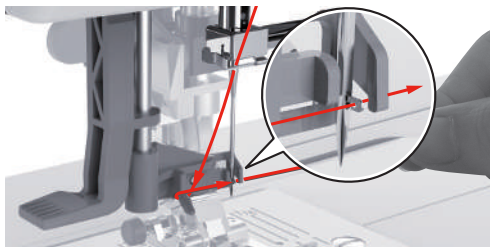
- > Guide the thread through the guides above the needle.
- > Lower the presser foot.



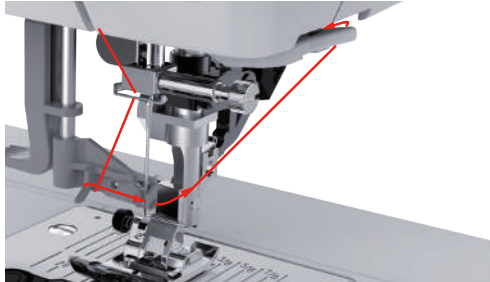
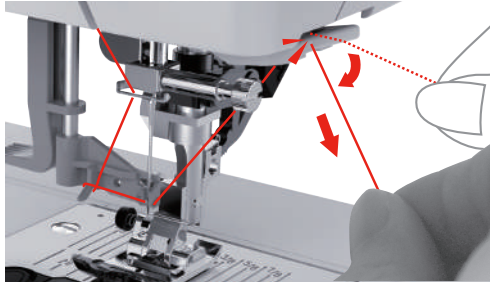
- > Press the threading lever down until it clicks into place.
 - The wire hook goes through the eye of the needle.
 - To prevent damage to the threader, the presser foot is lowered automatically.



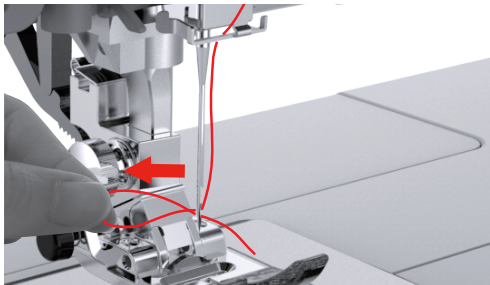
- > Feed the thread around the thread guide.
- > Guide the thread in front of the needle and underneath the wire hook and hold it.



- > To cut off excess thread, take the thread end and carefully pull it over the thread cutter. **Please Note:** Use the right thread cutter only when threading.



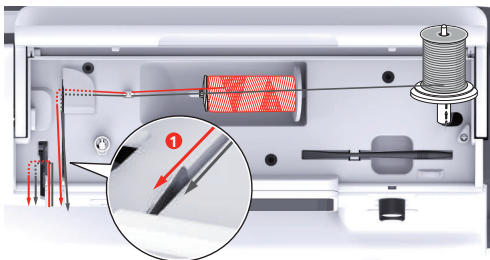
- > To thread the needle, lift the needle-threading lever. Keep the thread loose when doing so.
 - The wire hook moves backwards and pulls the thread through the needle eye into a loop.
- > Pull the thread completely through the eye of the needle.



Threading the Twin Needle

Prerequisite:

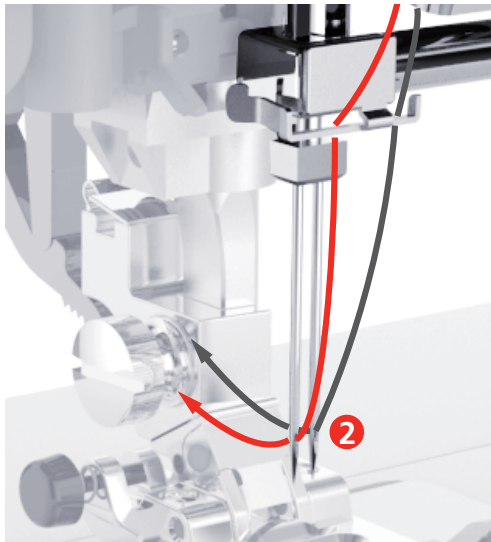
- The zigzag foot is fitted.
 - The twin needle is inserted.
 - The second spool pin, felt disc and second spool are fitted.
- > Guide the thread from the horizontal spool pin (red) in the direction of the arrow to the left side of the thread tension disc (1).



- > Guide the thread to the thread guide above the needle.



- > Thread the thread into the left needle manually.

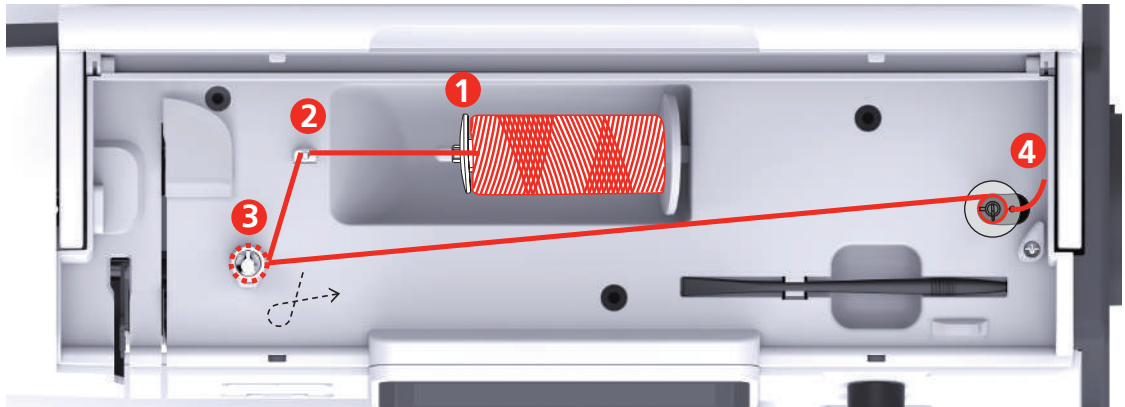


- > Guide the thread from the vertical spool pin (blue) in the direction of the arrow to the right side of the thread tension disc (1).
- > Guide the thread to the thread guide above the needle.
- > Thread the thread into the right needle manually.

NOTICE**Needle Breakage Caused by Incorrect Presser Foot, Stitch or Needle Position**

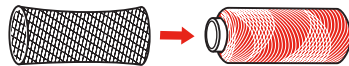
If the presser foot, stitch or needle position is incorrect, the needle can collide with the presser foot or stitch plate and break.

- > Fit the zigzag foot.
- > Set a straight stitch.
- > Set the needle to the center position.

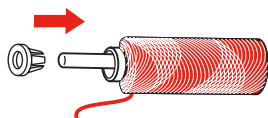
Winding the Bobbin Thread

- | | |
|----------------|----------------------------|
| 1 Spool Cap | 3 Bobbin Winder Pretension |
| 2 Thread Guide | 4 Spool Pin |

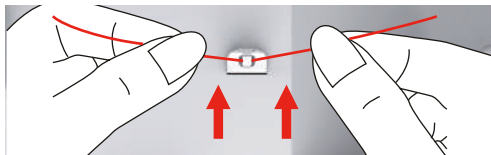
- > To prevent slippery threads from catching or breaking, pull the spool net over the spool.



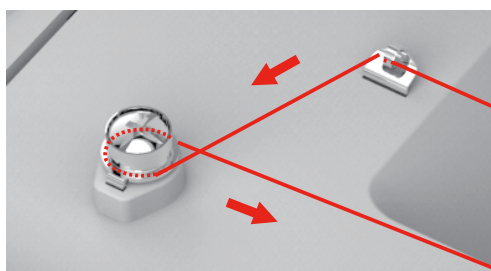
- > Place the thread spool and the appropriate spool cap on the spool holder. Use the small spool cap on the spool holder.



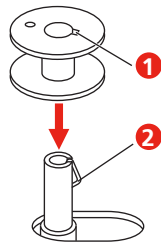
- > Feed the thread through the thread guide.



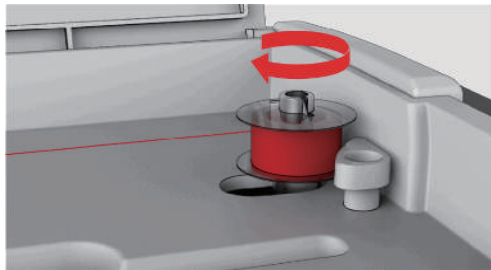
- > Guide the thread around the bobbin winder pre-tension in the direction of the arrow.



- > Pull the end of the thread through one of the inner holes on the bobbin and place the empty bobbin on the bobbin winding unit.



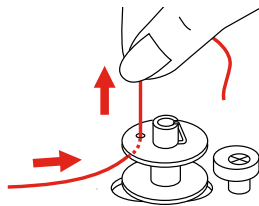
- > Push the bobbin to the right-hand position.



- The button «Start/Stop» flashes and the display for winding appears.



- > Hold the end of the thread tightly with one hand.



- > To start the winding process for a few rotations and then stop, push the button «Start/Stop», so that the thread is held tight on the bobbin.

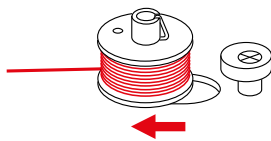
- > Cut the end of the thread above the inner hole.



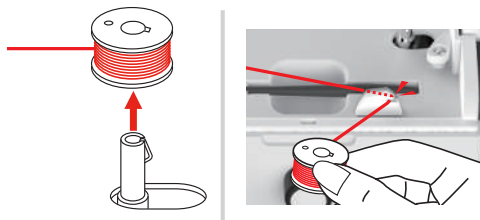
- > To continue the winding process, push the button «Start/Stop».

- > To stop the winding process, push the button «Start/Stop».

- > Push the bobbin winding unit to the left into the starting position.



- > Remove the bobbin and cut the thread.



Threading the Bobbin Thread

NOTICE

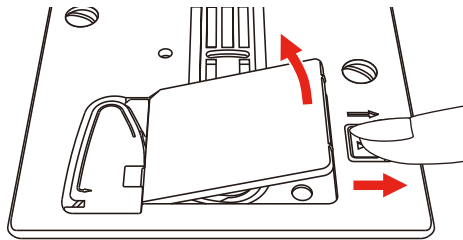
Needle Breakage Caused by Unevenly Wound Bobbins

Unevenly wound bobbins can lead to incorrect thread tension or cause needles to break.

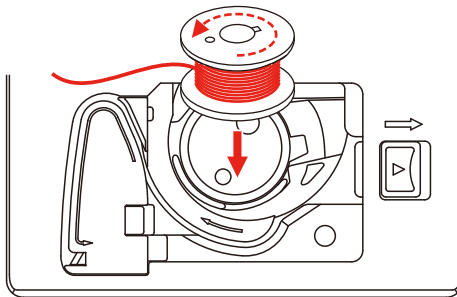
- > Only use evenly wound bobbins.

Prerequisite:

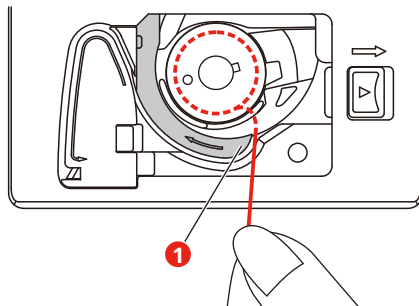
- The needle is raised.
 - The presser foot is raised.
 - The machine is switched off.
- > To open the bobbin cover, push the handle to the right and remove the bobbin cover.



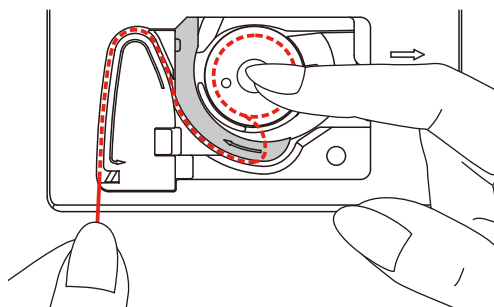
- > Insert a new bobbin so that the thread is wound anti-clockwise.



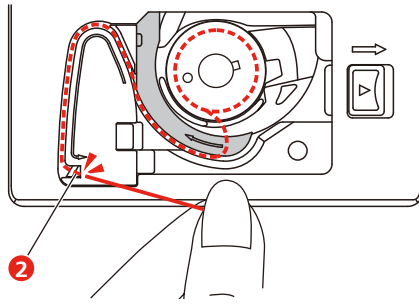
- > Pull the thread into the slit (1).



- > Press gently on the bobbin.
 > Follow the arrow markings to bring the thread into the bobbin thread guide.



- > To cut off excess thread, take the end of the thread and pull it over the thread cutter (2).



- > Attach the bobbin cover.

3 Setup Program

3.1 Sewing Settings

Adjusting the Upper Thread Tension

Changes to the upper thread tension in the Setup Program affect all of the stitch patterns. The setting in the setup is retained after the machine is switched off.



> Tap «Setup Program».



> Tap «Sewing Settings».



> Tap «Adjusting the Upper Thread Tension».
> Adjust the upper thread tension.

Adjusting the Maximum Sewing Speed

The maximum speed can be reduced by this function.



> Tap «Setup Program».



> Tap «Sewing Settings».



> Tap «Maximum Sewing Speed».
> Set the maximum sewing speed.

Programming Securing Stitches

If the function is switched on, at the start of the pattern, 4 securing stitches are automatically sewn after the thread cut.



> Tap «Setup Program».



> Tap «Sewing Settings».



> Switch «Securing Stitches at the Start of the Pattern» on or off.

Adjusting the Hovering Height of the Presser Foot

The hovering height of the presser foot can be adjusted according to the fabric thickness from 1 to maximal 6 mm.



> Tap «Setup Program».



> Tap «Sewing Settings».



> Tap «Programming Buttons and Icons».



> Tap «Programming the Hovering Height of the Presser Foot».

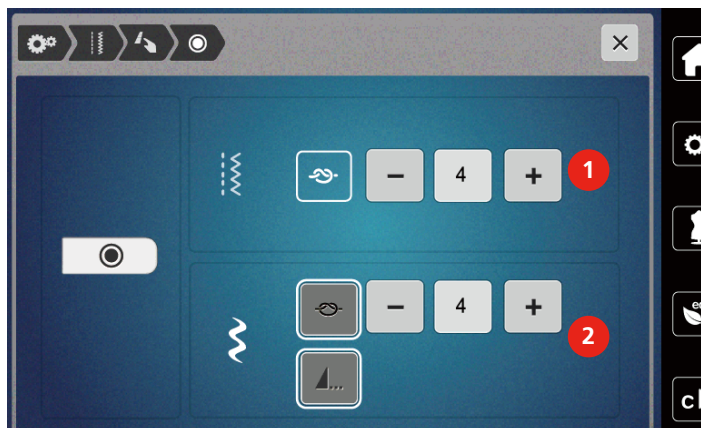
> To set the distance between the stitch plate and the presser foot, turn the «Upper Multi-function Knob» or «Lower Multi-function Knob», or tap «Plus»/«Minus».

Programming the Button «Securing»

Number and type of securing stitches can be programmed.

The number of securing stitches for practical stitches can be programmed in the upper section of the display (1).

Securing of decorative stitches or stitch pattern combinations can be programmed in the lower section of the display (2).



> Tap «Setup Program».



> Tap «Sewing Settings».



> Tap «Programming Buttons and Icons».



> Tap «Programming the Button Securing».

> To program the number of securing stitches for practical stitches, tap «Plus» or «Minus» in the upper section of the display (1).



- > To activate automatic securing for decorative stitches and stitch pattern combinations, tap «Securing Stitches».
- > To program the number of securing stitches at short intervals, tap «Plus» or «Minus» in the lower section of the display (2).
- > To deactivate automatic securing for decorative stitches and stitch pattern combinations, tap «Securing Stitches» again.



- > To activate securing for the selected pattern at the end, tap «Pattern End».
- The machine secures and stops at the end of the pattern.
- > To deactivate securing at the end of the pattern, tap «Pattern End» again.

Programming the Button «Thread Cutter»

The automatic securing can be programmed before the thread cut takes place.



- > Tap «Setup Program».



- > Tap «Sewing Settings».



- > Tap «Programming Buttons and Icons».



- > Tap «Programming the Button Thread Cutter».



- > To sew four securing stitches before cutting, tap «Securing Stitches».
- > To program the number of securing stitches, tap «Minus» or «Plus».
- > To deactivate automatic securing, tap «Securing Stitches» again.

Adjusting the Presser Foot Position with Needle Stop Down

With lowered needle, the presser foot is raised to hovering position when the needle is programmed in the down position.



- > Tap «Setup Program».



- > Tap «Sewing Settings».



- > Tap «Programming Buttons and Icons».



- > Tap «Pressure Foot Position with Needle Stop Down».



- > To activate the presser foot raised in the hovering position with needle stop downward, tap the switch.
- > To deactivate the presser foot raised in the hovering position with needle stop downward, tap the switch again.

Programming the Button «Quick Reverse»

You can choose between «Reverse Sewing» and «Stitch-specific Reverse Sewing».



> Tap «Setup Program».



> Tap «Sewing Settings».



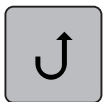
> Tap «Programming Buttons and Icons».



> Tap «Programming the Button Quick Reverse».



> To activate stitch-precise reverse sewing, tap «Back Stepping».



> To activate reverse sewing, tap «Quick Reverse».

Programming the "Needle Up/Down" Button

The hovering height of the presser foot can be set for the sewing stop with the lower needle.



> Tap «Setup Program».



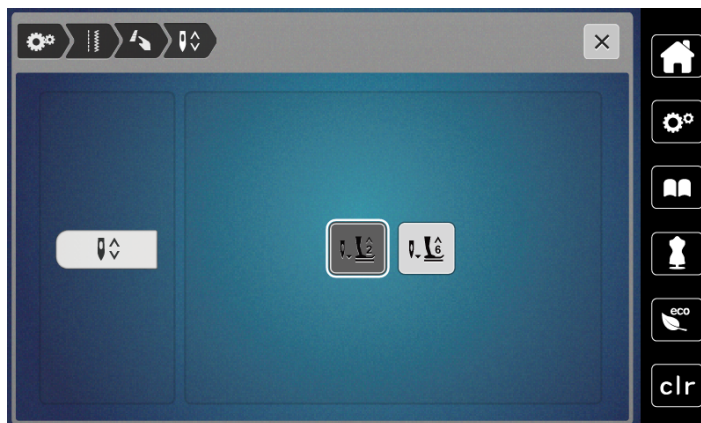
> Tap «Sewing Settings».

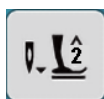


> Tap «Programming Buttons and Icons».



> Tap «Programming the Needle Up/Down Button».





> To set the hovering height of the lower needle to 2 mm, tap «Presser Foot Hovering Height 2».



> To set the hovering height of the lower needle to 6 mm, tap «Presser Foot Hovering Height 6».

NOTICE! If the ruler foot is being used, the presser foot hovering height may be maximum 2 mm, in order to avoid a collision with the needle holder.

Programming the Foot Control Individually

If «Needle Up/Down» is activated, the needle is raised or lowered with the back-kick on the foot control. Alternatively, the presser foot can be positioned, the thread can be cut and the automatic securing can be programmed.



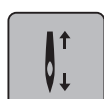
> Tap «Setup Program».



> Tap «Sewing Settings».



> Tap «Programming the Foot Control».



- «Needle Up/Down» is activated in the default setting.
- The back-kick on the foot control raises or lowers the needle.



> To program the Back-kick, tap «Programming the Back-kick».



- > To activate automatic securing via the back-kick, tap «Securing Stitches».
- > To program the number of securing stitches, tap «Plus» or «Minus».
- > To deactivate automatic securing via the back-kick, tap «Securing Stitches» again.



- > To activate automatic thread-cutting via the back-kick, tap «Automatic Thread Cutter».
- > To deactivate automatic thread-cutting via the back-kick, tap «Automatic Thread Cutter» again.



- > To keep the lowered position of the presser foot via the Back-kick, tap «Needle Up/Down».
- > To keep the raised position of the presser foot via the Back-kick, tap «Needle Up/Down» again.
 - If only «Needle Up/Down» without «Automatic Thread Cutter» and «Securing Stitches» is activated, the function can move the presser foot into the hovering position or into the highest position (12 mm).

Fabric Thickness Measurement

While sewing, the machine continuously checks the current fabric thickness and adjusts a proper presser foot pressure in time to keep a smooth feed of the fabric.



> Tap «Setup Program».



> Tap «Sewing Settings».



- > To activate the automatic foot pressure compensation, tap «Fabric Thickness Measurement».
- > To deactivate the automatic foot pressure compensation, tap «Fabric Thickness Measurement» again.

Adjusting the General Balance

Different fabrics, threads and stabilizers can affect the programmed stitch patterns so that they cannot be sewn out correctly. The electronic balance can correct these deviation and the stitch pattern can be adjusted optimally to the selected fabric.



- > Select a stitch pattern or alphabet.
- > Tap «Setup Program».



- > Tap «Sewing Settings».



- > Tap «Balance».
 - A preview of the stitch pattern is displayed.
- > To correct the longitudinal direction of the stitch pattern, turn the «Multi-function Knob» until the preview of the stitch pattern matches the stitch pattern sewn on the fabric.

3.2 Selecting Personal Settings



- > Tap «Setup Program».



- > Tap «Personal Settings».
- > Select the desired display color.



3.3 Monitoring Functions

Activating the Upper Thread Indicator



- > Tap «Setup Program».



- > Tap «Monitoring Functions».



- > Tap the switch in the upper section of the display to deactivate the upper thread indicator.
- > Tap the switch again to activate the upper thread indicator.

Activating the Bobbin Thread Indicator



- > Tap «Setup Program».



- > Tap «Monitoring Functions».



- > Tap the switch in the lower section of the display to deactivate the bobbin thread indicator.
- > Tap the switch again to activate the bobbin thread indicator.

3.4 Sound On/Off



- > Tap «Setup Program».



- > To switch off all sounds, tap «Switching Sounds On/Off».
- > To switch on all sounds, tap «Switching Sounds On/Off» again.

3.5 Machine Settings

Adjusting the Brightness of the Display

The brightness of the display can be set to meet your individual needs.



- > Tap «Setup Program».



- > Tap «Machine Settings».



- > Tap «Display Settings».
- > Adjust the brightness of the display in the upper section of the screen.

Adjusting the Sewing Light

The brightness of the sewing light can be adjusted corresponding to the personal preferences.



- > Tap «Setup Program».



- > Tap «Machine Settings».



- > Tap «Display Settings».
- > Adjust the brightness of the sewing light in the lower section of the screen.



- > Tap the switch to switch the sewing light off.

- > Tap the switch again to switch the sewing light on.

Calibrating the Display

Please find further information on this topic in the chapter attachment below troubleshooting at the end of the instruction manual.



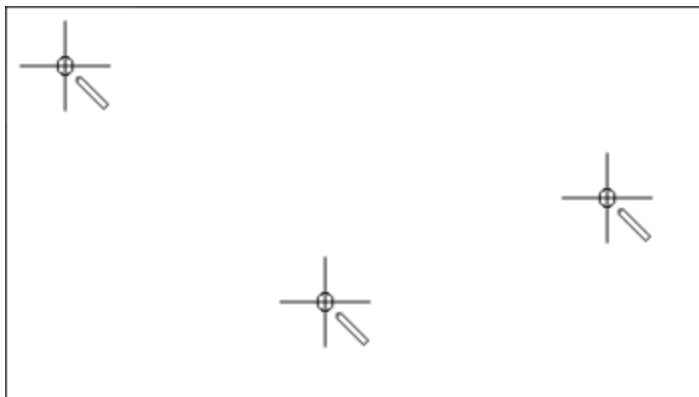
- > Tap «Setup Program».



- > Tap «Machine Settings».



- > Tap «Calibrating the Screen».
- > Touch the crosses in sequence using the touchscreen pen.



Back to basic settings

ATTENTION: Using this function will delete all individually made settings.



- > Tap «Setup Program».



- > Tap «Machine Settings».



- > Tap «Factory Setting».



- > Tap the «Default Setting Machine», confirm and start the machine again.

Checking the Firmware Version

The firmware version of the machine is displayed.



- > Tap «Setup Program».



- > Tap «Machine Settings».



> Tap «Machine Data».

Reviewing the Total Number of Stitches

The total stitch count of the machine and the number of stitches since the last service performed by a bernette dealer are displayed.

Four million stitches after a service, the symbol  recommends maintenance by specialized bernette dealer.



> Tap «Setup Program».



> Tap «Machine Settings».



> Tap «Machine Data».

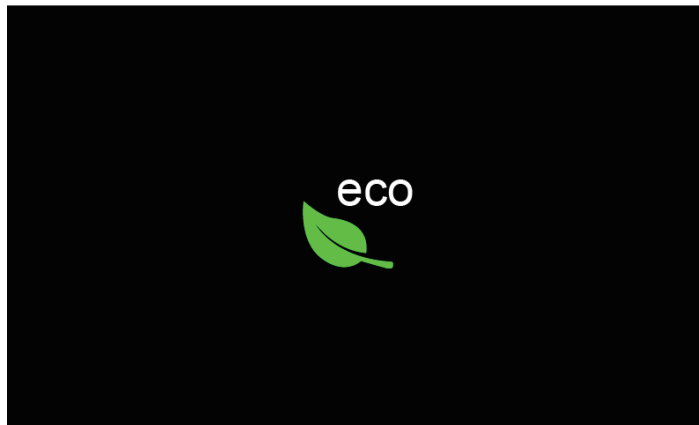
4 System Settings

4.1 Using eco Mode

If work is interrupted for an extended period, the machine can be put into energy-saving mode. Nothing can be selected in the display and the machine cannot be started.



- > Tap «eco Mode».
 - The display goes to sleep. The power consumption is reduced and the sewing light is off.



- > Tap «Eco mode» in the display.
 - The machine is ready for use.

4.2 Calling up the Creative Consultant

The Creative Consultant provides decision support for sewing projects. After entering the fabric and the desired sewing project, suggestions for suitable needles, presser feet etc. are displayed.

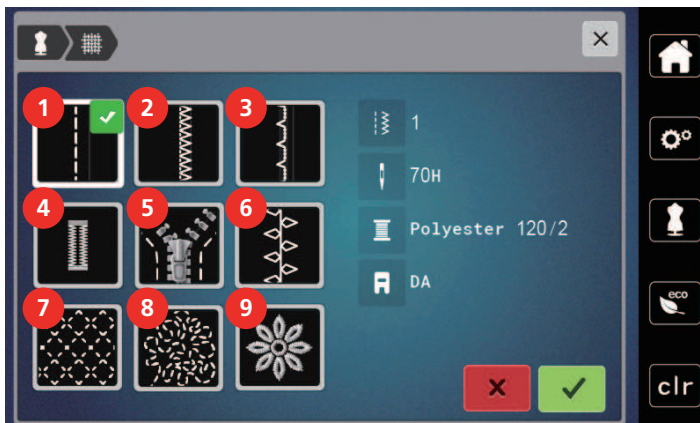


- > Tap «Creative Consultant».
- > Select the fabric to be sewn.

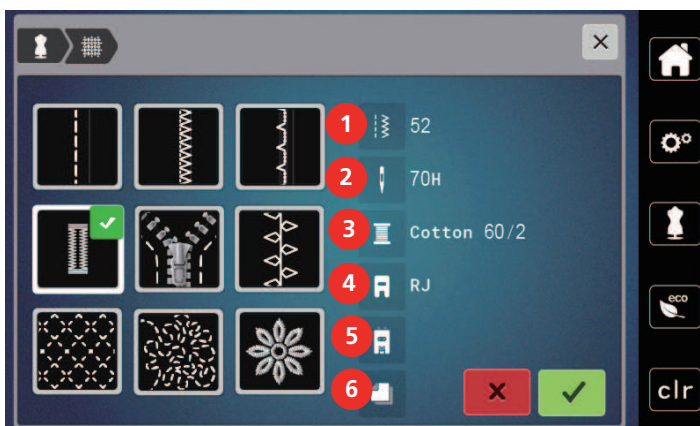


- | | |
|-----------------------|--------------------------------|
| 1 Light-weight Woven | 7 Heavy Knits |
| 2 Medium-weight Woven | 8 Fur/Imitation Fur |
| 3 Heavy-weight Woven | 9 Toweling |
| 4 Jeans | 10 Fabric with a Piled Texture |
| 5 Light Knits | 11 Leather and Vinyl |
| 6 Medium-weight Knits | 12 Net and Lace |

- > Select the sewing project.
 - The stitch is changed automatically, but all other settings must be done by the user.



- | | | | |
|---|-----------------|---|--------------------|
| 1 | Seams | 6 | Decorative Sewing |
| 2 | Finishing Edges | 7 | Machine Quilting |
| 3 | Blindstitch Hem | 8 | Free Motion Sewing |
| 4 | Buttonholes | 9 | Appliqués |
| 5 | Zips | | |



- | | | | |
|---|---------------------------|---|--------------------------|
| 1 | Recommended Stitch Number | 4 | Recommended Presser Foot |
| 2 | Recommended Needle | 5 | Reinforced Buttonhole |
| 3 | Recommended Thread | 6 | Stabilizer Recommended |

- > Make the settings of the machine according to the instructions.

4.3 Cancelling Any Alterations with «clr»

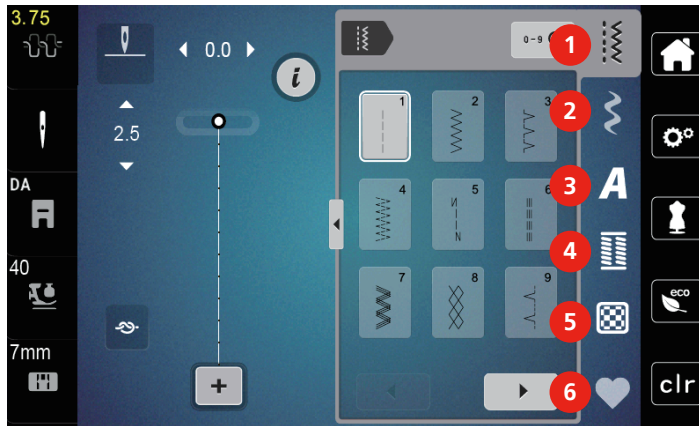
Any alterations to designs can be reset to basic setting. Exceptions are saved designs which have been filed in the personal memory and monitoring functions.

- > Tap «Clear Settings».



5 Creative Sewing

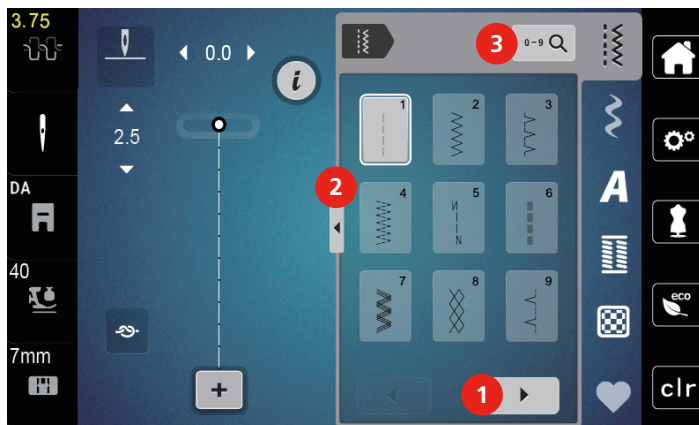
5.1 Overview Selection Menu Sewing



- | | | | |
|---|-----------------------|---|-------------------|
| 1 | «Practical Stitches» | 4 | «Buttonholes» |
| 2 | «Decorative Stitches» | 5 | «Quilt Stitches» |
| 3 | «Alphabets» | 6 | «Personal Memory» |

Selecting a Stitch Pattern

- > Select a stitch pattern, alphabet or buttonhole.
- > To display further stitch patterns, scroll to the right (1).
- > To increase the view, tap «Increasing/Decreasing the Display Size» (2).
- > To minimize the stitch pattern view, tap «Increasing/Decreasing the Display Size» (2) again.
- > To select the stitch pattern by inputting the stitch number, tap «Select Stitch Pattern by Number» (3).
 - If «!!!» appear when entering the stitch pattern, the stitch pattern cannot be used in the Combi mode.
 - If «???» appear when entering the stitch pattern, the stitch pattern doesn't exist.



5.2 Dual feed



It is recommended to match the presser foot pressure with the fabric. The thicker the fabric, the lower the presser foot pressure.

The Dual Feed feeds the fabric from above and from beneath simultaneously. This provides an even and careful feed forward even for smooth and thin materials. Striped and checkered patterns can be matched perfectly by even feeding.

Application of the Dual Feed

In general, the Dual Feed is used for the following sewing projects:

- Sewing: All sewing applications with difficult fabrics such as for seams, zippers.
- Patchwork: With accurate stripes, blocks and with decorative stitches up to a stitch width of 7 mm.
- Appliqués: sewing appliques, ribbons and bias binding.

Difficult-to-work-with fabrics are:

- Velvet, normally sewn with the grain
- Toweling
- Jersey, especially when sewing it crosswise to knit
- Fake fur or coated fake fur
- Fleece-types of fabrics
- Batted fabrics
- Stripes and checks
- Curtain fabrics with pattern repeats

«Sticky» fabrics are:

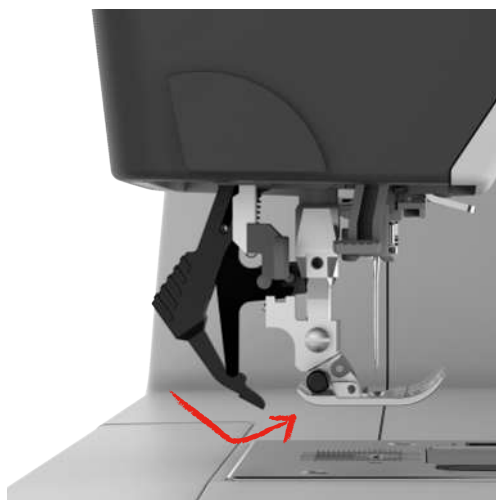
- Imitation leather, coated fabrics

Use the Dual Feed



When working with the Dual Feed, only use presser feet with the rear opening.

- > Raise the presser foot.
- > Swing the DF mechanism forward under the back of the presser foot until it clicks in position.



- > Raise the presser foot.
- > Pull down the DF mechanism and swing it to the rear to disengage.

5.3 Regulating the Speed

The sewing speed can be adjusted infinitely variable with the slide.

- > Move the slide to the left to reduce the sewing speed.
- > Move the slide to the right to increase the sewing speed.

5.4 Adjusting the Upper Thread Tension

The default setting of the upper thread tension is set automatically as soon as a stitch pattern is selected.

When using different types of sewing threads, the upper thread tension may vary. It may therefore be necessary to adjust the upper thread tension individually according to the sewing project as well as the desired stitch.

The higher the upper thread tension is set, the tighter the upper thread is tensioned, and the bobbin thread is pulled deeper into the fabric. When the upper thread tension is low, the upper thread is less tightened, and the bobbin thread is pulled up less into the fabric.

Alteration of the upper thread tension affect the currently stitch pattern. Permanent alterations of the upper thread tension for the sewing can be made in the Setup Program.



- > Tap «Upper Thread Tension».
- > To increase or decrease the upper thread tension, move the slider.



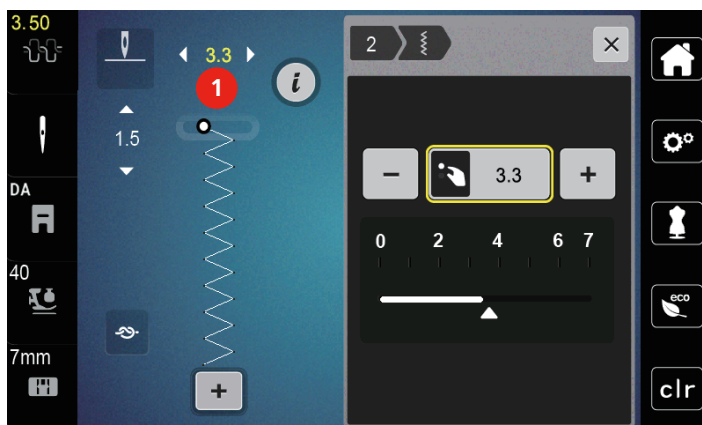
- 1 Permanent Alteration of Thread Tension
- 2 Thread Tension of the Current Embroidery Design

5.5 Editing Stitch Patterns

Changing the Stitch Width

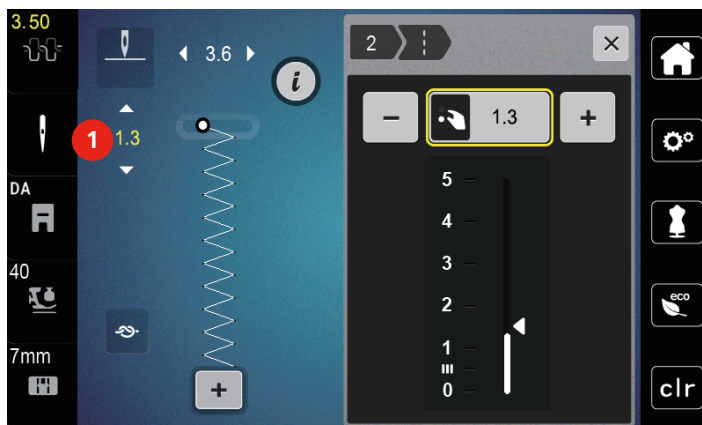
- > Turn the «Upper Multi-function Knob» to the left to narrow the stitch width.
- > Turn the «Upper Multi-function Knob» to the right to widen the stitch width.

- > To call up further setting options, tap the icon «Stitch width» (1).



Changing the Stitch Length

- > Turn the «Lower Multi-function Knob» to the left to shorten the stitch length.
- > Turn the «Lower Multi-function Knob» to the right to elongate the stitch length.
- > To call up other setting options, tap «Stitch Length» (1).



Correcting the Balance

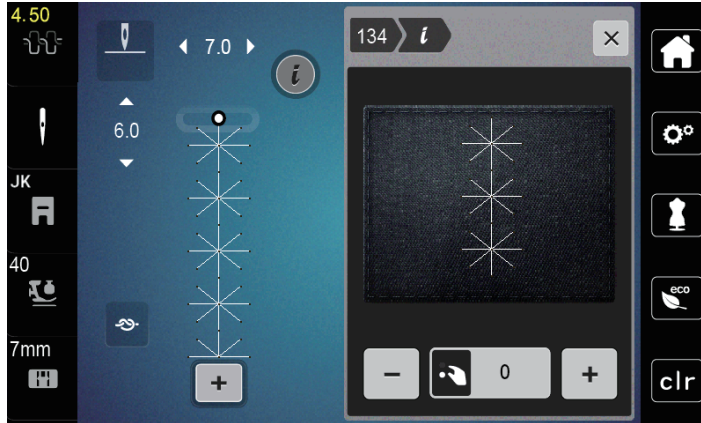
Different fabrics, threads and stabilizers can affect the programmed stitch patterns so that they cannot be sewn out correctly. The electronic balance can correct these deviation and the stitch pattern can be adjusted optimally to the selected fabric.

- > Select a stitch pattern or alphabet.
- > Sewing stitch pattern.
- > Tap «i-Dialog».





- > Tap «Balance».
- A preview of the stitch pattern is displayed.



- > To correct the longitudinal direction of the stitch pattern, turn the «Lower Multi-function Knob» until the preview of the stitch pattern matches the stitch pattern sewn on the fabric.



- > Altered Balance settings can be saved for each stitch in the «Personal Memory» .
- > Altered Balance settings only remain valid until the «Clear Settings» is pushed or the machine is switched off.

Programming Pattern Repeat



- > Select a stitch pattern or alphabet.
- > Tap «i-Dialog».



- > To repeat the stitch pattern, tap «Pattern Repeat» once.
- > To repeat the stitch pattern up to nine times, tap «Pattern Repeat» two to nine times.
- The machine stops automatically after the programmed number of patterns has been sewn.



- > To secure a backstitch at the end of sewing, «Securing Stitches» is activated.
- > To deactivate securing, tap «Securing Stitches».

Mirror Image of Stitch Patterns



- > Select a stitch pattern or alphabet.
- > Tap «i-Dialog».



- > To mirror the stitch pattern from left to right, tap «Mirror Image Left/Right».



- > To mirror the stitch pattern in sewing direction, tap «Mirror Image Up/Down».

Edit Stitch Pattern Length

Stitches from category satin stitch pattern can be lengthwise extended or shortened.

- > Select a stitch pattern.



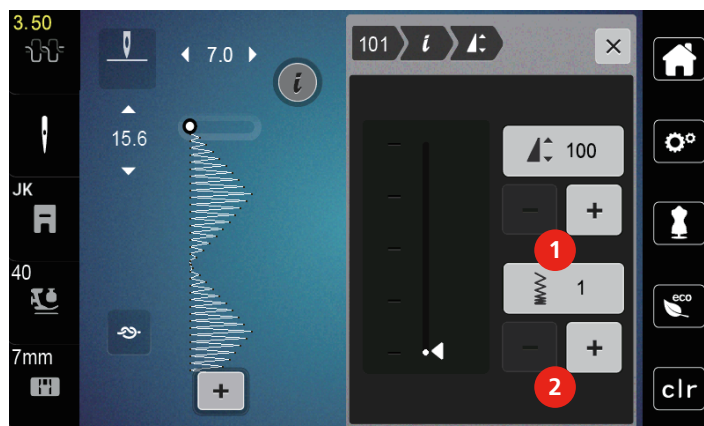
> Tap «i-Dialog».



> Tap «Edit Stitch Pattern Length».

> To set the stitch pattern length, push the slide or tap «Plus»/«Minus» (1).

> To determine the density of the stitch pattern, tap «Plus»/«Minus» (2).



Permanent Quick Reverse

> Select a stitch pattern or alphabet.

> Tap «i-Dialog».



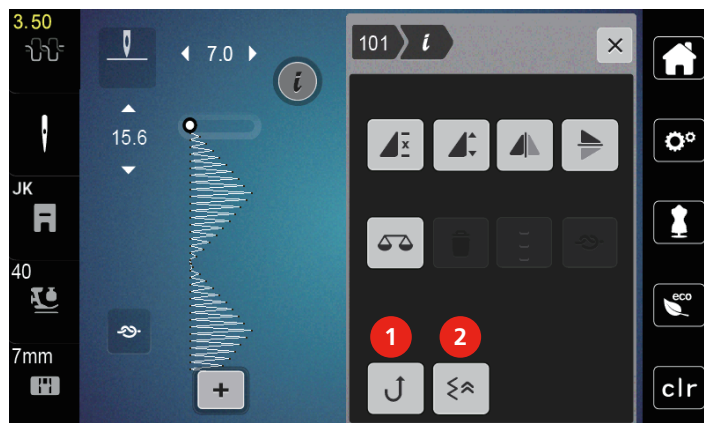
> To sew backward permanently, tap «Quick Reverse» (1).

Backstepping

> Select a stitch pattern, alphabet or buttonhole.

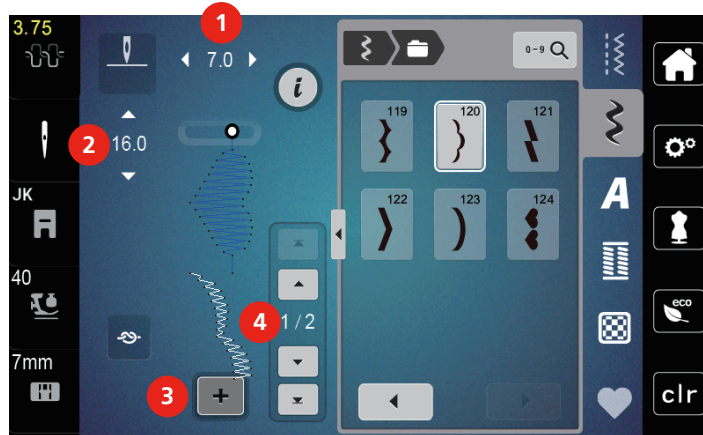
> Tap «i-Dialog».

> For stitch-precise reverse sewing, tap «Back Stepping» (2).



5.6 Combining Stitch Patterns

Overview Combi Mode



- | | | | |
|---|-----------------|---|--|
| 1 | «Stitch Width» | 3 | «Combination Mode/Single Mode» |
| 2 | «Stitch Length» | 4 | Individual Stitch Pattern within the Combination |

Creating Stitch Pattern Combinations

In the Combi mode stitch patterns and alphabets can be combined according to your wish. Each combination can hold up to 20 stitches. Patterns created in the Stitch Designer cannot be integrated in the pattern combinations.

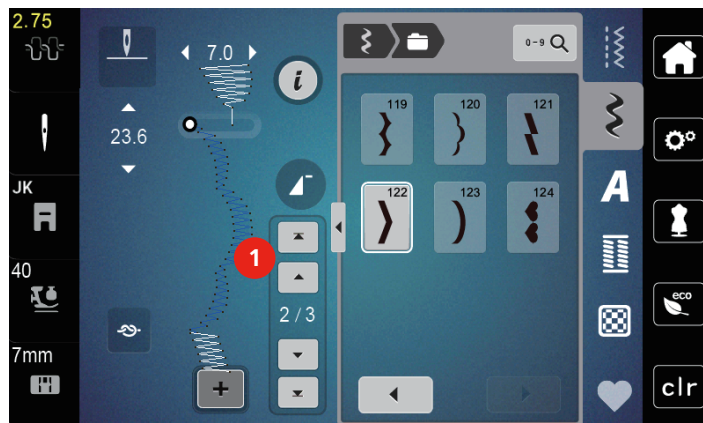


- > Tap «Combination Mode/Single Mode» (3).
- > Select the desired stitch patterns.
- > To get back to the Single Mode, tap «Combination Mode/Single Mode» again.

Editing a Single Stitch Pattern

Prerequisite:

- A stitch pattern combination has been created.
- > To select a single stitch pattern, tap the desired position (1) within the stitch pattern combination.



- > To edit the single stitch pattern, tap «i-Dialog».

Deleting a Single Stitch Pattern

- > Create a stitch pattern combination.
- > To select a single stitch pattern, tap the desired position (1) within the stitch pattern combination.



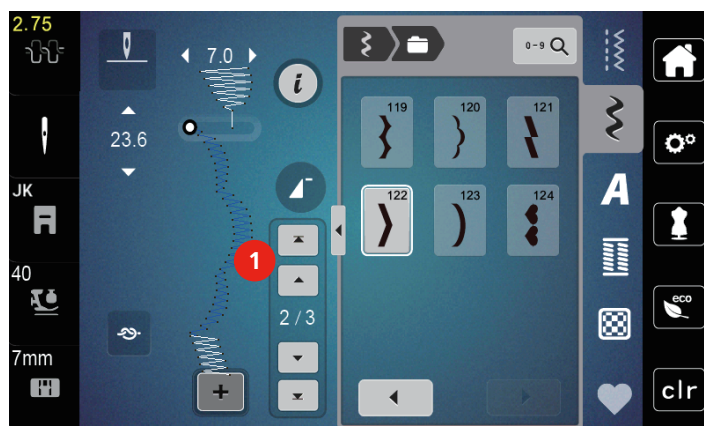
- > Tap «i-Dialog».



- > To delete the single stitch pattern, tap «Deleting».

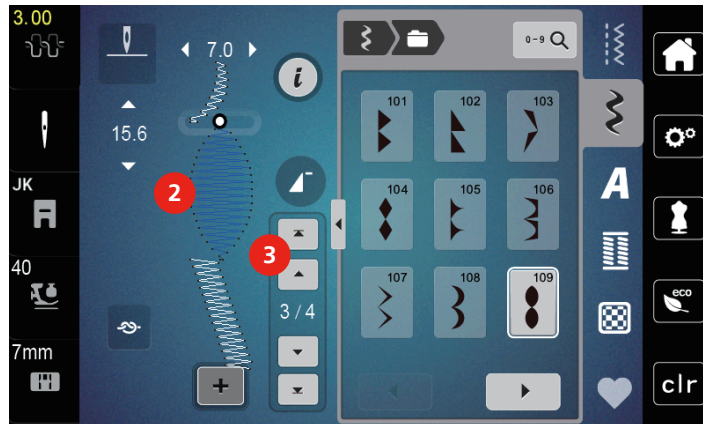
Adding a Single Stitch Pattern

- > To add a stitch pattern at the start, go right to the front of the stitch pattern group and tap the second upper arrow (1).
 - Both upper arrows are inactive.
- > Add a new stitch pattern.



- > Create a stitch pattern combination.

- > To select a new stitch pattern according to the selected stitch pattern, tap the desired position (2) within the stitch pattern combination or use the arrow (3).



Mirroring a Stitch Pattern Combination

Prerequisite:

- A stitch pattern combination has been created.



- > Tap «i-Dialog».
- > Tap «Edit Entire Combination».



- > To mirror the whole stitch pattern combination from left to right, tap, «Mirror Image Left/Right».
- > To reset the changes and revert to the default settings, tap «Mirror Image Left/Right».

Programming Pattern Repeat



- > Create a stitch pattern combination.
- > Tap «i-Dialog».
- > Tap «Edit Entire Combination».



- > To repeat the stitch pattern combination, tap «Pattern Repeat» once.
 - «Securing» at the final end of the combination is activated.
- > To repeat the stitch pattern combination up to nine times, tap «Pattern Repeat» again.
- > To switch off the pattern repetition, press and hold «Pattern Repeat» until an «X» appears in place of a number.

Securing a Stitch Pattern Combination

Securing at the end of the stitch pattern combination is deactivated. To activate securing at the end of the stitch pattern combination:



- > Create a stitch pattern combination.
- > Tap «i-Dialog».
- > Tap «Edit Entire Combination».



- > Tap «Securing Stitches».

Saving a Stitch Pattern Combination

To use an individually created stitch pattern combinations again, they can be saved in the folder «Personal Memory».

Prerequisite:

- A stitch pattern combination has been created.



> Tap «Personal Memory».



> Tap «Save Stitch Pattern».



> To save the stitch pattern combination, tap «Confirm».

Loading a Stitch Pattern Combination



> Tap «Combination Mode/Single Mode».



> Tap «Personal Memory».



> Tap «Loading a Stitch Pattern Combination».

> Select a stitch pattern combination.

Overwriting a Stitch Pattern Combination

Prerequisite:

- A stitch pattern combination has been created.



> Tap «Personal Memory».



> Tap «Save Stitch Pattern».

> Select the stitch pattern combination which is to be overwritten.



> To overwrite the stitch pattern combination, tap «Confirm».

Deleting a Stitch Pattern Combination

Prerequisite:

- A stitch pattern combination has been created.



> Tap «i-Dialog».

> Tap «Edit Entire Combination».



> Tap «Deleting».



> Tap «Confirm».

5.7 Administering Stitch Patterns

Saving Stitch Patterns in Personal Memory

In the filing system «Personal Memory» any stitch patterns, also those which have been individually edited, can be saved.

- > Select a stitch pattern, alphabet or buttonhole.
- > Edit the stitch pattern.
- > Tap «Personal Memory».



- > Tap «Save Stitch Pattern».



- > Tap «Confirm».

Overwriting Stitch Patterns from the Personal Memory

Prerequisite:

- The stitch pattern is saved in the personal memory.
- > Select a stitch pattern, alphabet or buttonhole.
- > Edit the stitch pattern.
- > Tap «Personal Memory».



- > Tap «Save Embroidery Design».
- > Select the stitch pattern which should be overwritten.



- > Tap «Confirm».

Loading Stitch Patterns from the Personal Memory

Prerequisite:

- The stitch pattern is saved in the personal memory.
- > Tap «Personal Memory».



- > Tap «Load Embroidery Design».
- > Select a stitch pattern.

Deleting Stitch Patterns from the Personal Memory

Prerequisite:

- The stitch pattern is saved in the personal memory.

- > Tap «Personal Memory».



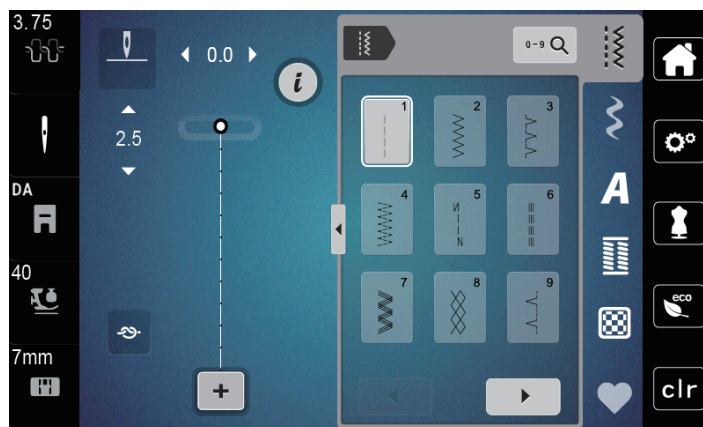
- > Tap «Deleting».
- > Select a stitch pattern.
















- > Tap «Confirm».

6 Practical Stitches

6.1 Overview Practical Stitches



Stitch Pattern	Stitch Number	Name	Description
	1	Straight Stitch	Seams and topstitching.
	2	Zigzag	Reinforcing seams, overcasting edges, sewing elastic seams and attaching lace.
	3	Vari-Overlock	Sewing and finishing in one step of elastic fabrics.
	4	Running Stitch	Darning with running stitch, mending fabrics, reinforcing edges.
	5	Securing Program	Securing starts and ends of seams by straight stitching.
	6	Triple Straight Stitch	Reinforced seams in heavy fabrics; visible hems and seams.
	7	Triple Zigzag	Reinforced seams in heavy fabrics; visible hems and seams.
	8	Honeycomb Stitch	For stretch fabrics and hems. Is also used with elastic thread in the bobbin.
	9	Blind Stitch	Blind hems, shell edging effect on soft jerseys and fine material, decorative seams.
	10	Double Overlock	Sewing and finishing in one step of elastic fabrics.
	11	Superstretch Stitch	For highly stretch open seams. For all types of clothing.

Stitch Pattern	Stitch Number	Name	Description
	12	Gathering Stitch	Most types of fabric; gathering with shirring elastic, butted seams = butting two pressed edges and sewing together, decorative stitches.
	13	Stretch Overlock	Sewing and finishing in one step of elastic fabrics.
	14	Tricot Stitch	Visible hems, visible seams in lingerie, sweaters, mending jersey.
	15	Universal Stitch	For firm fabrics such as felt and leather. Flat joining seams, visible seams, attaching elastic, decorative seams.
	16	Sewn-out Zigzag	Edge finishing and reinforcing, attaching elastic, decorative seam.
	17	Lycra Stitch	For lycra fabrics; flat joining seams and hems, reinforced seaming on underwear.
	18	Stretch Stitch	For highly stretch fabrics; open seam for sportswear.
	19	Reinforced Overlock	For medium-weight knitware and toweling. Overlock seams, flat joining seams.
	20	Knit Overlock	Sewing and finishing in one step of hand and machine knitted fabrics.
	21	Basting Stitch	For seams and hems.
	22	Simple Darning Program	Darning of holes and damaged fabric.
	23	Reinforced Darning Program	Reinforcing darning holes and damaged fabric.
	24	Bartack Program	Reinforcing pocket openings, sewing belt loops.

6.2 Sewing Straight Stitch



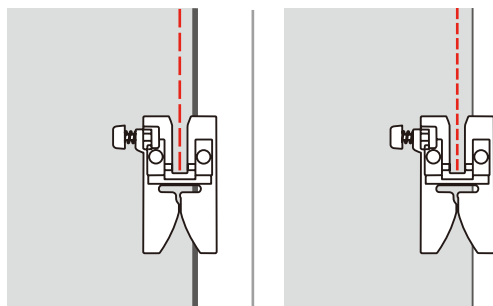
Adjust the stitch length for the sewing project, e.g. a long stitch for denim (approx. 3 – 4 mm) and a short stitch for delicate fabric (approx. 2 – 2.5 mm). Adjust the stitch length depending on the thread thickness, e.g. a long stitch (approx. 3 – 5 mm) for top-stitching with gimp.

Prerequisite:

- The Zigzag Foot (DA) is attached.



- > Tap «Practical Stitches».
- > Select Straight Stitch No. 1.



6.3 Securing with the Automatic Securing Program

Due to a determined number of 6 stitches sewn forwards and 6 stitches sewn in reverse, the securing is regular.

Prerequisite:

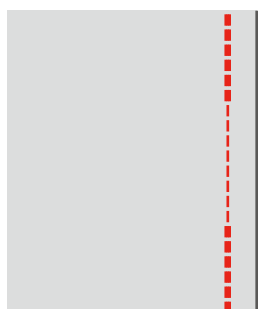
- The Zigzag Foot (DA) is attached.



- > Tap «Practical Stitches».
- > Select the Securing Program No. 5.
- > Press the foot control.
 - The machine secures automatically.
- > Sew the seam in the desired length.



- > Push the button «Securing Stitches».
 - The machine secures automatically and stops at the end of the securing program.

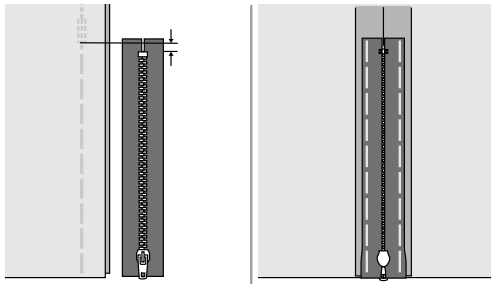


6.4 Sewing in the Zipper

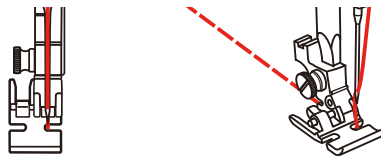


As the fabric feed can be difficult when starting to sew, it is recommended to hold the threads firmly or to pull the fabric slightly to the back for a few stitches or to sew 1 – 2 cm reverse first.

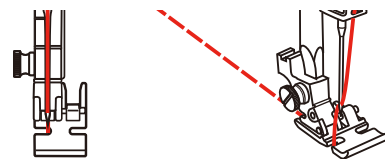
- > Attach the Zigzag Foot (DA).
- > Tap «Practical Stitches».
- > Select Straight Stitch No. 1.
- > Close the zipper length with long stitches.
- > Finish the seam allowances individually.
- > Iron the seam apart.
- > Open the zipper length.
- > Baste the zipper under the fabric so that the fabric folded edges meet over the center of the zipper.



- > Attach the Zipper Foot (JB).
- > When sewing the left-hand side of the zipper, secure the right-hand side of the presser foot pin using the holder.

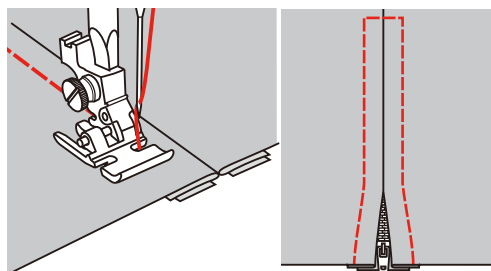


- > When sewing the right-hand side of the zipper, secure the left-hand side of the presser foot pin using the holder.



- > Sew the left-hand side of the open zipper from top to bottom.
- > Close the zipper up to approx. 5 cm from the end.
- > Sew over the lower end and the right-hand side of the zipper.
- > Stop before the zipper slider.
- > Move the needle into the lower position.
- > Raise the presser foot.
- > Open the zipper.
- > Finish sewing the right side.

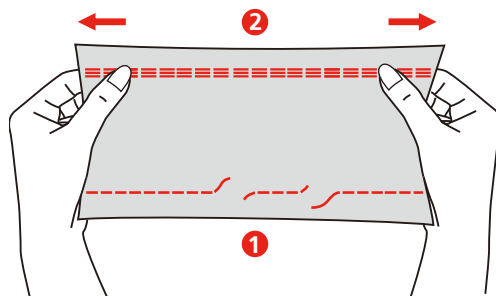
- > Remove the tacked seam.



6.5 Sewing Triple Straight Stitch

The triple straight stitch is especially suitable for durable seams and for firm, densely woven fabrics such as denim and corduroy.

- > Attach the Zigzag Foot (DA).
- > Tap «Practical Stitches».
- > Select the Triple Straight Stitch No. 6.



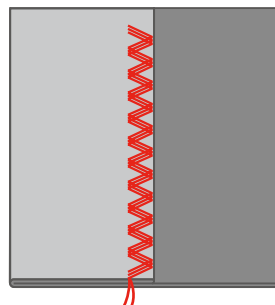
1 Straight Stitch

2 Triple Straight Stitch

6.6 Sewing Triple Zigzag

In firm fabrics, particularly for denim fabrics, deckchair covers, awnings. Hems on items that are frequently washed. Finish the seam edges first.

- > Attach the Zigzag Foot (DA).
- > Tap «Practical Stitches».
- > Select the Triple Zigzag No. 7.

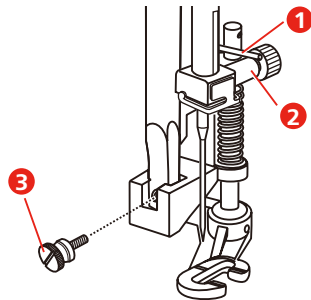


6.7 Manual Darning

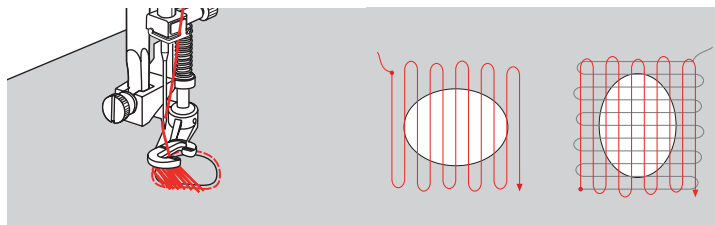
Used for darning holes or worn areas in all fabric types.

If the thread is lying on top and a poor stitch formation results, slow down the movement of the sewing project. If there are knots on the wrong side of the fabric, move the sewing project faster. When the thread breaks, guide the sewing project more consistently.

- > Remove the presser foot holder and attach the free motion foot (RX) to the presser foot holder bar.
 - The pin (1) should rest on the upper side of the needle clamping screw (2).
- > Press the Free-motion Embroidery Foot (RX) firmly from below with your index finger and tighten the screw (3).



- > Tap «Practical Stitches».
- > Select Straight Stitch No. 1.
- > Lower the feed dog.
- > Attach the Slide-on Freearm Extension Table.
- > Hoop the sewing project in the round embroidery hoop (optional accessory).
 - The darning area remains evenly stretched and cannot be deformed.
- > Sew from the left to the right, guide the fabric evenly by hand without using pressure.
- > Move in curves when changing the direction to avoid holes and thread breakage.



6.8 Reinforced Darning, Automatic

The simple Darning Program No. 22 is especially suitable for quick darning of worn or damaged areas. It is recommended to use fine material as a backing for the worn and damaged areas or to stick an adhesive interlining. The simple Darning Program No. 22 replaces threads along the lengthwise grain in all materials. If the darning area becomes distorted, correct with the balance.

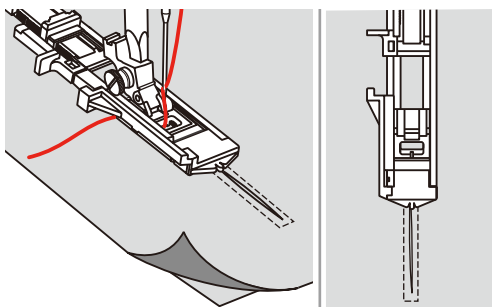
The reinforced Darning Program No. 23 is especially suitable for quick darning of worn or damaged areas. The reinforced Darning Program No. 23 replaces threads along the lengthwise or transverse grain in all materials.

Prerequisite:

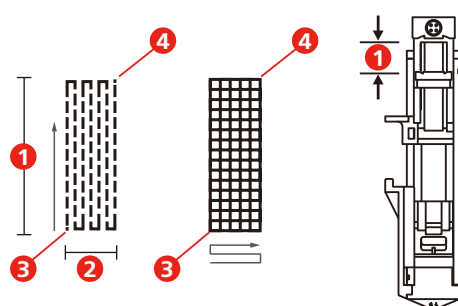
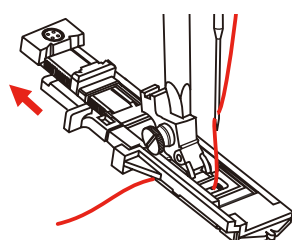
- The underlay material is fixed with basting stitches.
- > Attach the Buttonhole Foot with Slide (RJ).
- > Tap «Practical Stitches».
- > Select the reinforced Darning Program No. 23.



- > Lower the presser foot over the center of the tear.



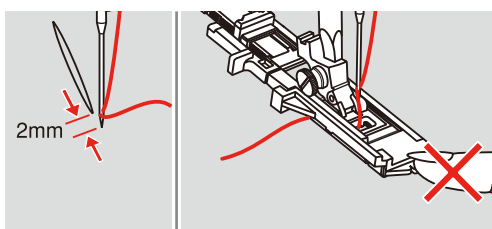
- > Adjust the button holder on the buttonhole foot to the desired length. The size of one darning sequence is variable.
 - The maximum sewing length is 2.6 cm (1 inch) and the maximum sewing width is 7 mm (9/32 inch).



- | | | | |
|---|----------------------|---|-------|
| 1 | The Length of Sewing | 3 | Start |
| 2 | The Width of Sewing | 4 | Stop |

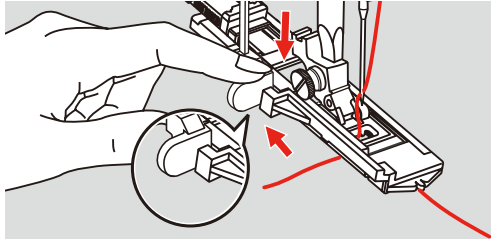
- > Position the fabric so that the needle is 2 mm (1/16 inch) in front of the area to be darned.
- > Lower the presser foot.

When lowering the presser foot, do not push the front of the presser foot, otherwise the darning will not be sewn in the correct size.

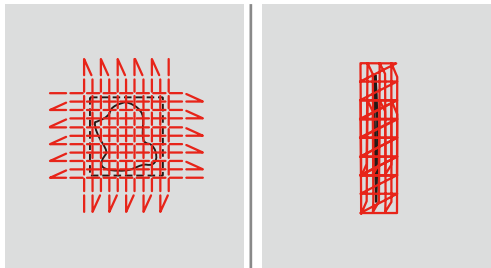


- > Lead the upper thread down through the hole in the presser foot.
- > Pull down the buttonhole lever as far as possible.
 - The buttonhole lever is positioned behind the bracket on the buttonhole foot.

- > Hold the upper thread to the left side vertically to the Buttonhole Foot with Slide and start sewing.



- > If the sewing range is too big to sew, then we recommend to sew the area several times (or cross sew) to get better sewing result.



6.9 Finishing Edges

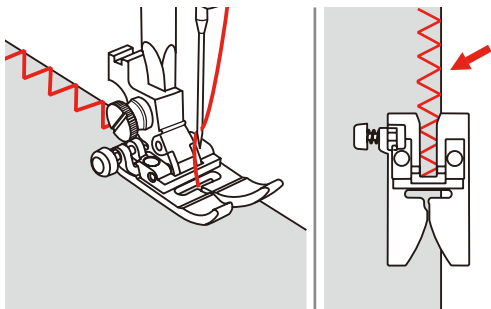
The zigzag stitch is suitable for finishing all types of fabric. Use darning thread for fine materials.

Prerequisite:

- The edge of the fabric should lie flat and not roll.



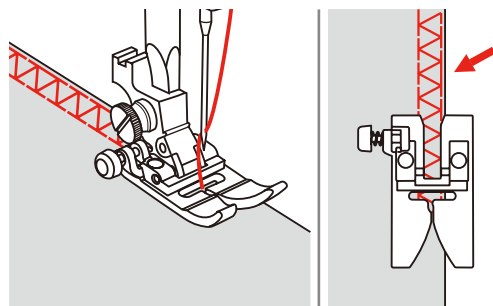
- > Attach the Zigzag Foot (DA).
- > Attach the Zigzag Foot (DA).
- > Tap «Practical Stitches».
- > Neither select too wide a stitch nor too long a stitch.
- > Guide the edge of the fabric into the center of the presser foot, so that the needle goes into the fabric on one side and over the edge into the air on the other side.



6.10 Sewing Double Overlock

A double overlock seam is suitable for looser knit fabric and for cross seams in woven fabric. When working with jersey, a jersey needle should be used to prevent damaging the knit fabric. When sewing stretch materials, use a stretch needle.

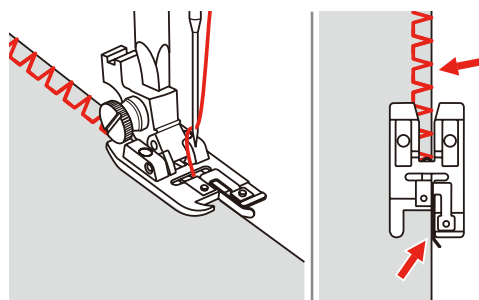
- > Attach the Zigzag Foot (DA).
- > Tap «Practical Stitches».
- > Select the Double Overlock No. 10.



6.11 Sewing Vari Overlock

Sewing overcasting stitches along the edges of fabric to prevent them from fraying. When sewing stretch materials, use a stretch needle.

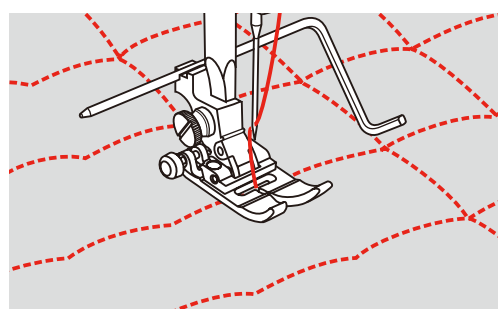
- > Attach the Overlock Foot (DI).
- > Tap «Practical Stitches».
- > Select the Double Overlock No. 3.
- > Sew the fabric with the fabric edge against the guide of the foot.



6.12 Edgestitching Using the Seam Guide

When sewing parallel wide top-stitching lines, we recommend guiding the seam guide along a sewn line.

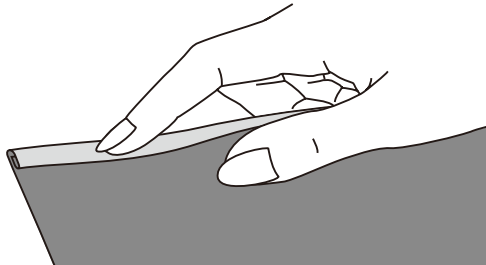
- > Attach the Zigzag Foot (DA).
- > Tap «Practical Stitches».
- > Select Straight Stitch No. 1.
- > Insert the seam guide into the hole of the presser foot.
- > Sew the first row and move over the fabric to sew subsequent rows with the guide riding along the previous row of stitching.



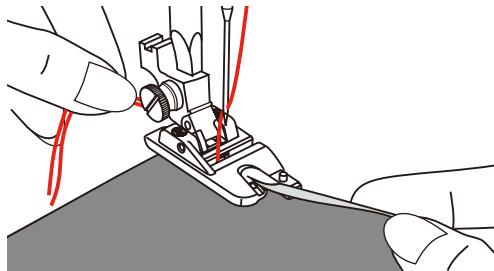
6.13 Sewing a Narrow Hem



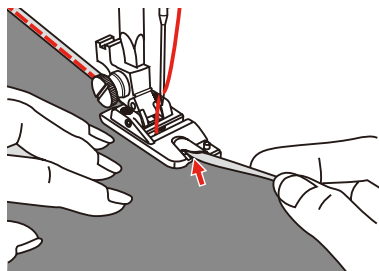
- > Attach the Hemmer Foot (DG) optional accessory.
- > Tap «Practical Stitches».
- > Select Straight Stitch No. 1.
- > Fold the edge of the fabric over about 3 mm, then fold it over again 3 mm for about 5 cm along the edge of the fabric.



- > Place the edge of the fabric with the left-hand side of the fabric facing up under the presser foot. The fabric under the presser foot should be just less than the width of the presser foot.
- > Sew 4 – 5 stitches.
- > Raise the needle and presser foot.
- > Pull the fabric backwards by about 10 – 15 cm. Do not cut the thread.
- > Hold the 4 threads in your left hand. Pull the edge of the fabric into the spiral guide on the hemmer foot using your right hand.

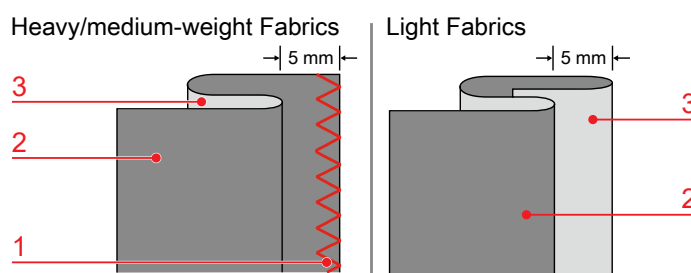


- > Lower the presser foot.
- > Continue sewing slowly while slightly folding the cut edge of the fabric in front of the hemmer foot and holding it to the left. Guide the edge of the fabric evenly into the spiral guide on the hemmer foot and sew.



6.14 Sewing Blind Hems

For invisible hems in medium to heavy weight cotton, wool and blended materials.



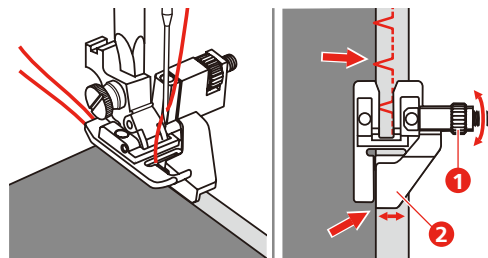
1 Finishing Seam

2 Left-hand Fabric Side

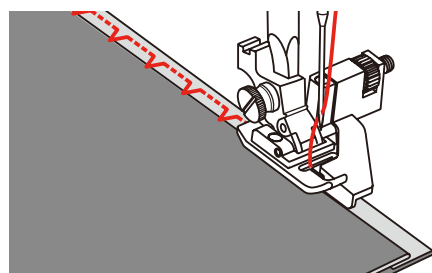
3 Right-hand Fabric Side

Prerequisite:

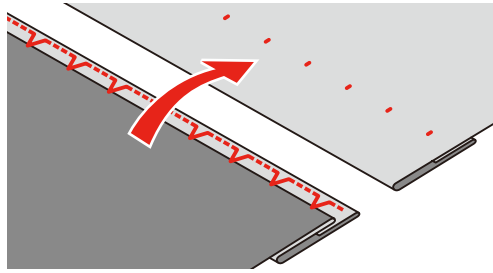
- The fabric edges are finished.
- > Attach the Blindstitch Foot (DM).
- > Tap «Practical Stitches».
- > Select the Blindstitch No. 9.
- > Fold the fabric as illustrated with the wrong side up.
- > Place the fabric beneath the presser foot.
- > Turn the handwheel anti-clockwise until the needle is all the way to the left.
The needle should just pierce the fold in the fabric (3). If it does not, adjust the stitch width accordingly.
- > Adjust the guide (2) by turning the dial (1) so that the guide is positioned directly against the fold.



- > Sew slowly while guiding the fabric carefully along the edge of the guide.



- > Turn over the fabric.

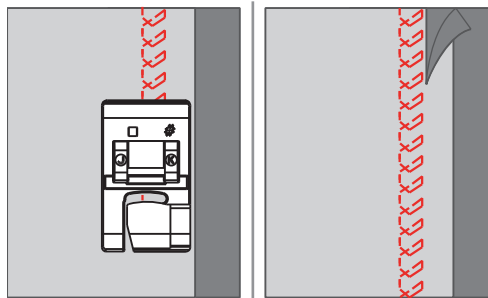


6.15 Sewing Visible Hems

The visible hem is particularly suitable for elastic seams in tricot made of cotton, wool, synthetic and mixed fibers.



- > Attach the Embroidery Foot (JK).
- > Tap «Practical Stitches».
- > Select the Tricot Stitch No. 14.
- > Iron the hem and baste if necessary.
- > Reduce the presser foot pressure if necessary.
- > Sew the hem in the desired depth on the right side of the fabric.
- > Trim off the remaining fabric on the wrong side of the fabric.



6.16 Sewing Basting Stitches

When sewing basting stitches, it is recommended to use a fine darning thread. This is easier to remove. The longest stitch possible is 5 mm. The recommended stitch length is 3.5 – 5 mm. The basting stitch is suitable or sewing projects where a very long stitch length is required.

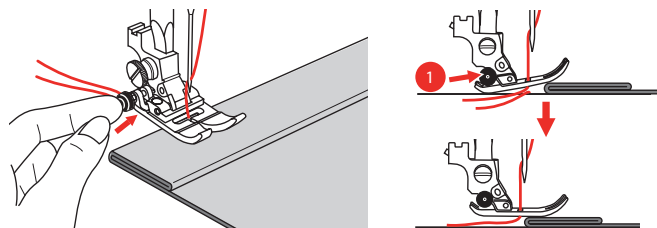


- > Attach the Zigzag Foot (DA).
- > Tap «Practical Stitches».
- > Select the Basting Stitch No. 21.
- > Select the stitch length.
- > Pin the fabric layers at a right angle to basting direction to prevent the layers from slipping.
- > Sew 3 – 4 securing stitches at the beginning and at the end.

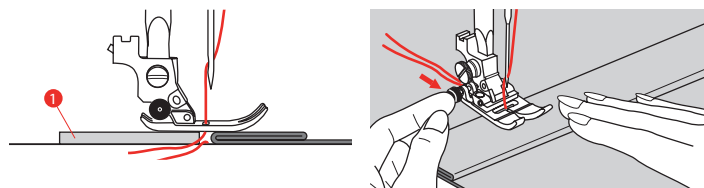
6.17 Sew Thick Areas

- > Attach the Zigzag Foot (DA).
 - The black button on the left side of the presser foot will lock the presser foot in a horizontal position if you push it in before lowering the presser foot (1). This ensures even feeding at the beginning of a seam and helps when sewing multiple layers of fabric such as sewing over seams when hemming jeans.
- > Once the highest point has been reached, lower the needle and raise the presser foot.

- > Press the foot tip and the black knob, lower the presser foot and continue sewing.
 - The black button releases automatically after sewing few stitches.



- > To support the presser foot when manually guiding the fabric and sewing from the folded side, place one, two or three small plates from the height compensating tool (1) behind the needle under the presser foot.



1 Height Compensating Tool

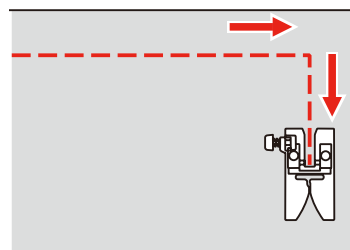
6.18 Sewing Corners



- > Stop the machine when the corner is reached.
- > Pierce the needle into the fabric.



- > Raise the presser foot.
- > Use the needle as a pivot and turn the fabric.
- > Lower the presser foot and continue sewing.



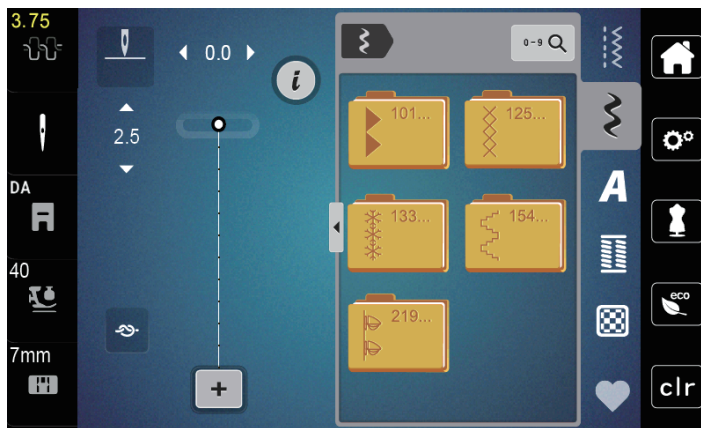
7 Decorative Stitches

7.1 Overview Decorative Stitches

Easier or more difficult decorative stitches come into their own depending on the type of fabric.

- Decorative stitches which are programmed with simple straight stitches are particularly appropriate for light-weight materials, e.g. the Decorative stitch No. 142.
- Decorative stitches which are programmed with triple straight stitches or with a few satin stitches are particularly appropriate for medium-weight materials, e.g. Decorative stitch No. 152.
- Decorative stitches which are programmed with satin stitches are particularly appropriate for medium-weight materials, e.g. Decorative stitch No. 101.

For a perfect stitch formation, it is of advantage to use the same thread color for upper and bobbin thread and a stabilizer. With pile or longfiber materials, it is recommended to use an additional water-soluble stabilizer, which can be easily removed after sewing, on the right side of the fabric.



Decorative Stitch	Stitch Number	Name
	101-124	Satin Stitches
	125-132	Cross Stitches
	133-153	Nature Stitches
	154-218	Geometric Stitches
	219-233	Children Stitches

7.2 Altering the Stitch Density

With satin stitches (e. g. No. 101) the stitch density can be altered. A larger number means a larger stitch distance, i.e. the stitch is sewn less densely. For a high stitch density, the number must be decreased. Stitch density 1 is the minimum. The set stitch pattern length is not changed by altering the stitch density.

- > Select the satin stitch.
- > Tap «i-Dialog».



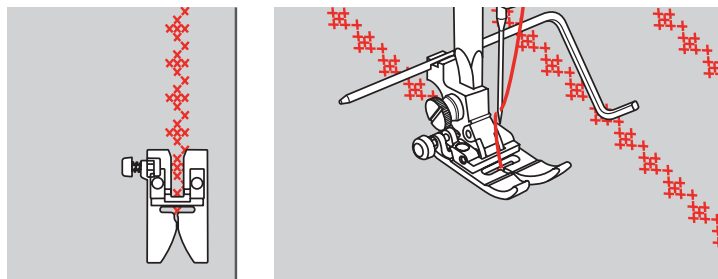
- > Tap «Altering the Pattern Length/Stitch Density».
- > To increase the stitch density, tap (1) «Minus».
- > To reduce the stitch density, tap (1) «Plus».



7.3 Sewing Cross Stitches

Cross stitch embroidery is a traditional technique and an addition to the other decorative stitches. If the cross stitches are sewn on fabrics with a linen structure, they look as if they were hand-stitched. When cross stitches are sewn with embroidery yarn, the stitch pattern appears fuller. Cross stitches are particularly used for home furnishing, trimmings on garments and embellishing in general. As every following line refers to the first row, it is important to stitch the first row in a straight line.

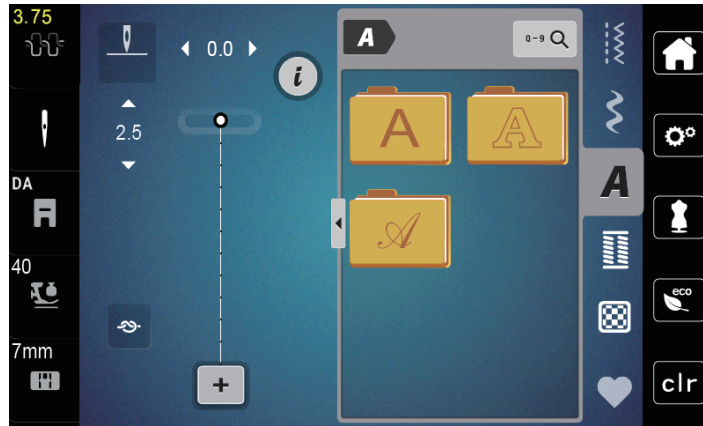
- > Attach the Zigzag Foot (DA) or the Embroidery Foot (JK) or the Open embroidery Foot (DN) (optional accessory).
- > Select a cross stitch of the Decorative stitch No. 125-132 and combine it as desired.
- > Stitch the first row using the seam guide to sew a straight line.
- > Stitch the second row next to the first at a distance of one presser foot's width or using the seam guide.



8 Alphabets

8.1 Overview Alphabet

Block, Double block and Script alphabets can be sewn in two different sizes, in upper and lower case letters. For a perfect stitch formation, it is recommended to use the same thread color for upper and bobbin threads. The fabric can be reinforced with embroidery stabilizer on the wrong side. Use an additional, water-soluble stabilizer on the right side of pile or napped fabrics.



Stitch Pattern	Name
ABCabc	Block alphabet
ABCabc	Double-Block
<i>ABCabc</i>	Script (Italics)

8.2 Creating Lettering



Sewing a test sample with the thread, the actual fabric and stabilizer you intend to use is recommended. Make sure that the fabric is fed evenly and lightly, ensuring that it cannot push against or catch on anything. The fabric shouldn't be pulled, pushed or held back.

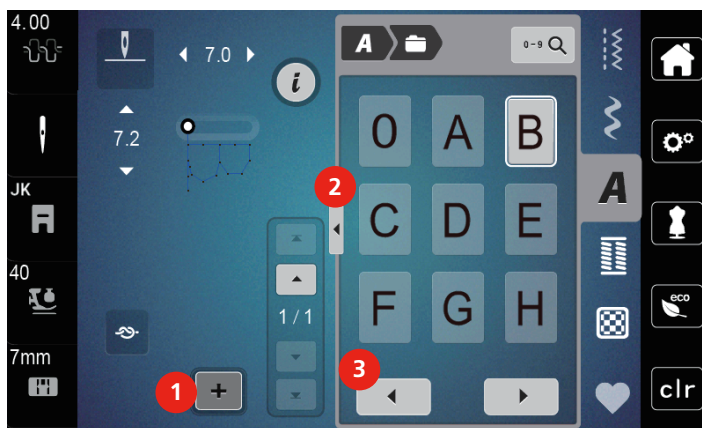


- > Select «Alphabets».
- > Select the font.



- > To create a combination, tap «Combination Mode/Single Mode» (1).

> To open the expanded input mode, tap «Show Alphabet» (2).



> Select the letters.



> To display further letters, tap «Scroll Left» (3).



> To delete single letters of the entered text, tap «Deleting».

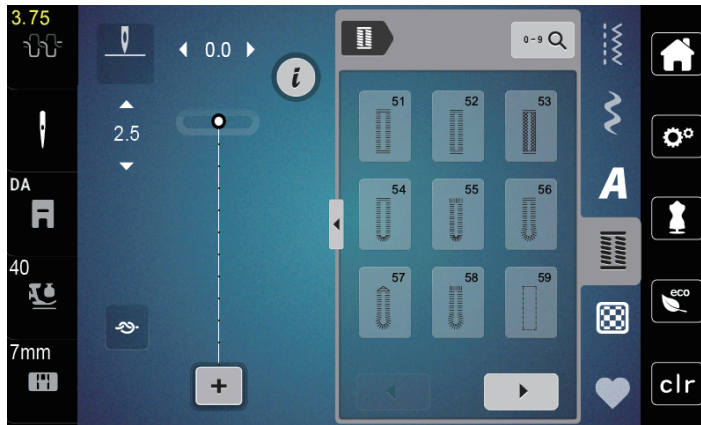
> To close the expanded input mode, tap «Show Alphabet» (1) again.




















9 Buttonholes

9.1 Overview Buttonholes

To be able to create the right buttonhole for every button, every purpose and also for every garment, the bennette b77 comes with an extensive collection of buttonholes. The corresponding button can be sewn on automatically. Eyelets can also be sewn.

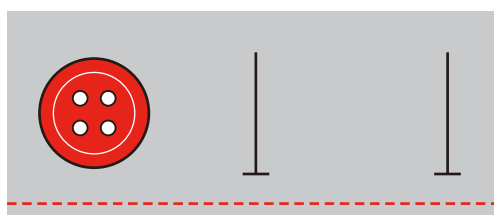


Buttonhole	Buttonhole Number	Name	Description
	51	Standard Buttonhole	For light to medium-weight fabrics. e.g. blouses, dresses and bed linen.
	52	Standard Buttonhole Narrow	For light to medium-weight fabrics. e.g. blouses, dresses, children's and baby clothes, crafts.
	53	Stretch Buttonhole	For any highly elastic jersey made from cotton, wool, silk and synthetic fibers.
	54	Round Buttonhole with Normal Bartack	For medium-weight to heavy fabrics, dresses, jackets, coats and rainwear.
	55	Round Buttonhole with Horizontal Bartack	For medium to heavy weight fabrics: dresses, jackets, coats, rainwear.
	56	Keyhole Buttonhole	For firmer, non-stretch fabrics, jackets, coats, leisure wear.
	57	Keyhole Buttonhole with Pointed Bartack	For firmer, non-stretch fabrics, jackets, coats, leisure wear.
	58	Keyhole Buttonhole with Horizontal Bartack	For firm, non-stretch fabrics: jackets, coats, leisure wear.
	59	Straight Stitch Buttonhole	Program for staystitching buttonholes, for pocket openings, reinforcing buttonholes, especially for buttonholes in leather and imitation leather.

Buttonhole	Buttonhole Number	Name	Description
	63	Heirloom Buttonhole	For light to medium-weight woven fabrics; blouses, dresses, leisure wear, bedlinen.
	64	Double-rounded Buttonhole	For medium to heavy-weight fabrics in all kinds of different materials.
	66	Buttonhole with Double Pointed Bartack, Narrow	Decorative buttonhole for medium weight fabrics; blouses, dresses, jackets.
	69	Decorative Buttonhole with Double Pointed Bartack	For decorative buttonholes in firmer, non-elastic fabrics.
	71	Stretch Buttonhole	For jeans or stretch fabric with a coarse weave.
	60	Button Sew-on Program	For buttons with 2 and 4 holes.
	61	Eyelet with Small Zigzag	Openings for cords and narrow ribbons, for decorative work.
	62	Eyelet with Straight Stitch	Openings for cords and narrow ribbons, for decorative work.

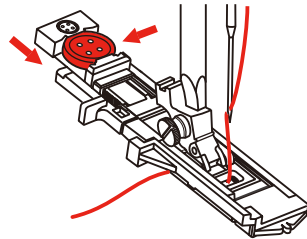
9.2 Marking Buttonholes

- > Mark the positions of the buttonhole on the fabric.
 - The maximum buttonhole length is 3 cm (1 3/16 inch). (Total of diameter + thickness of button.)
- > The size of the buttonhole is determined by the button inserted in the buttonholder plate.

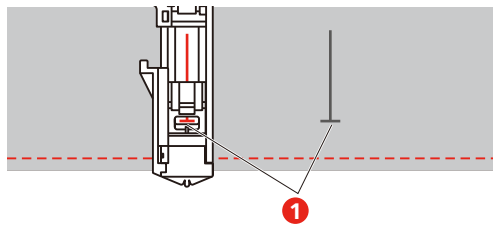


9.3 Sewing a Buttonhole Automatically

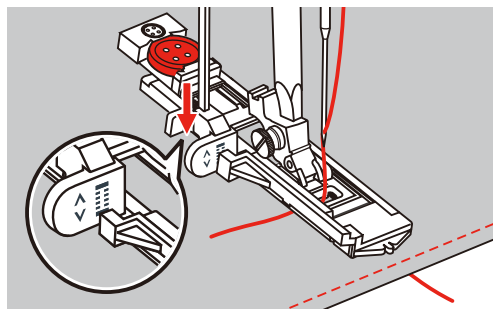
- > Attach the Buttonhole Foot with Slide (RJ).
- > Pull out the button holder plate and insert the button.
- > Pass the thread through the hole in the presser foot and then place it under the foot.
- > Tap «Buttonholes».
- > Select the buttonhole stitch.



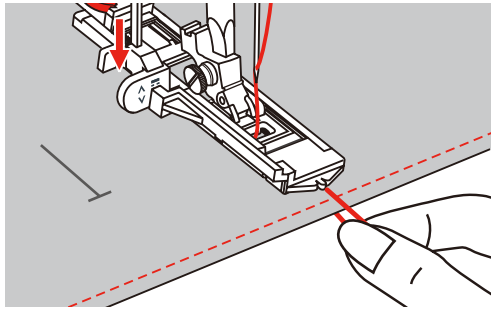
- > Adjust the stitch width and stitch length to the desired width and density.
- > Position the fabric under the presser foot so that marking of the centerline is aligned with the starting point (1).
- > Make sure that there is no gap between the presser foot tip and the plastic part.



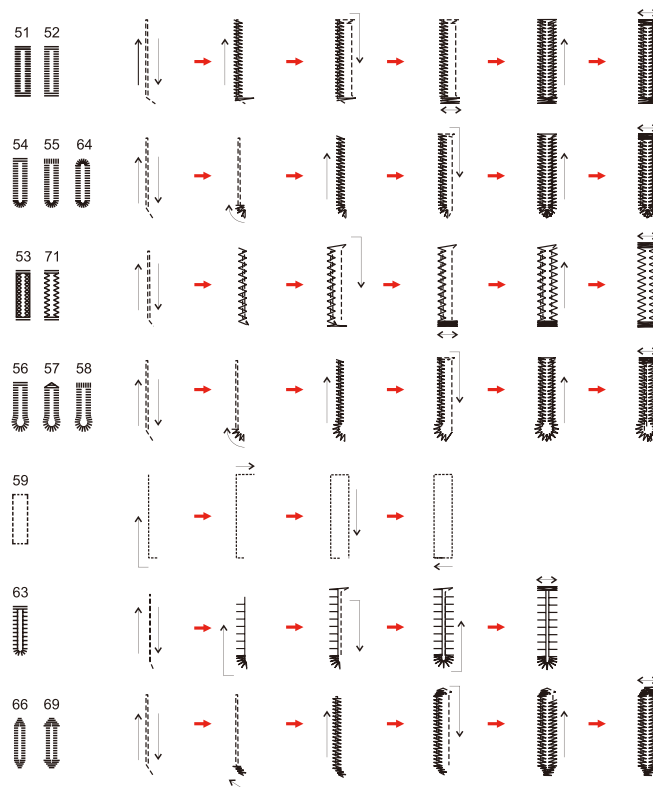
- > Push the button «Start/Stop».
 - While the buttonhole lever is raised, the display shows an error message to lower the buttonhole lever.
- > Pull the buttonhole lever down as far as possible until it clicks into place.



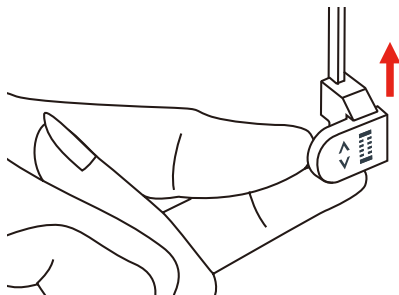
- > Hold the upper thread vertically to the buttonhole foot with slide and start sewing.
- After the buttonhole has been sewn, the machine automatically sews a securing stitch before stopping.



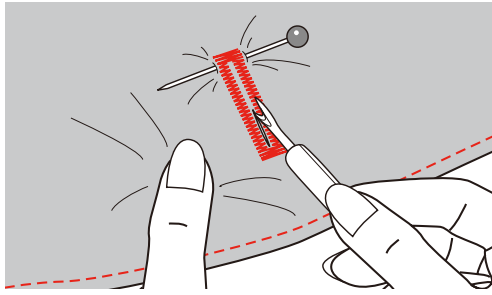
- The buttonholes are sewn backwards from the front of the presser foot as illustrated.



- > Raise the sewing foot and cut the thread.
- > After sewing the buttonhole, raise the buttonhole lever to the stop.



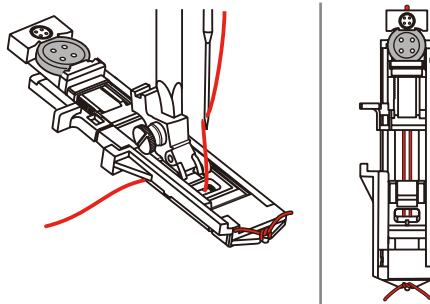
- > Cut the buttonhole open and make sure that the beads are not cut on either side. Use a pin as a stop at the bartack to avoid cutting too far.



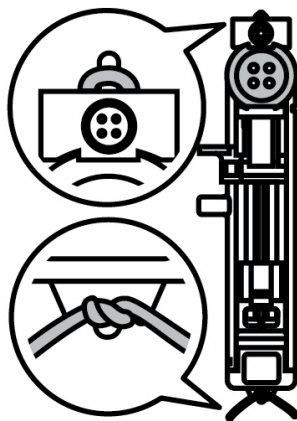
9.4 Reinforce Buttonhole

When sewing buttonholes on stretch fabric, hook a heavy thread or a cord under the buttonhole foot.

- > Attach the Buttonhole Foot with Slide (RJ).
- > Pull out the button holder plate and insert the button.
- > Pass the thread through the hole in the presser foot and then place it under the foot.

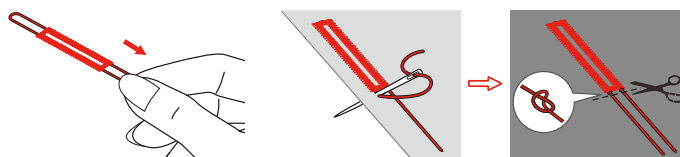


- > Bring the two cord ends to the front of the foot and insert them in the grooves, then temporarily tie them there.
- > The stitch width and stitch length has to be adjusted before the sewing starts.



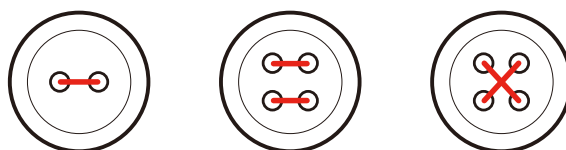
- > Lower the presser foot and sew the buttonhole.
 - The buttonhole will sew over the cord, covering it.
- > Pull the cord loop until the loop disappears in the bartack.

- > Pull the cord ends with the sewing needle to the back and knot or secure them.



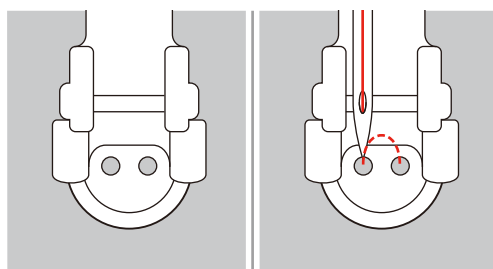
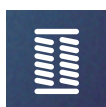
9.5 Sewing On Buttons

The Button Sew-on Program can be used to sew on buttons with two or four holes, press studs or snap fasteners. To enhance the stability, the Button Sew-on Program always stitches into the left hole of the button. As for a button with 4 holes, the two front holes should be sewn first.

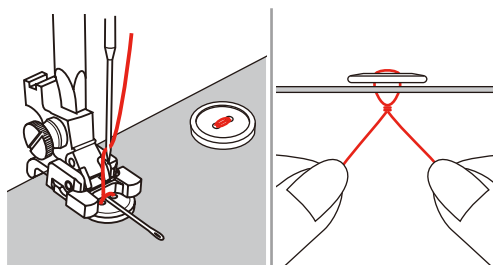


The first securing stitch of the Button Sew-on Program always stitches into the left hole of the button.

- > Attach the Button Sew-on Foot (RC).
- > Tap «Buttonholes».
- > Lower the feed dog.
- > Select the Button Sew-on Program No. 60.
- > Fit the button into the sewing project.
- > Check distances between holes with the handwheel. If necessary, alter the stitch width.



- > Hold the threads when starting to sew.
 - The machine sews the buttonhole program and stops automatically.
 - When a stem is needed, place a darning needle on the buttonhole and sew.
- > Pull the two bobbin threads until the thread ends of the upper threads are visible on the wrong side of the fabric.
- > Tie the threads manually.



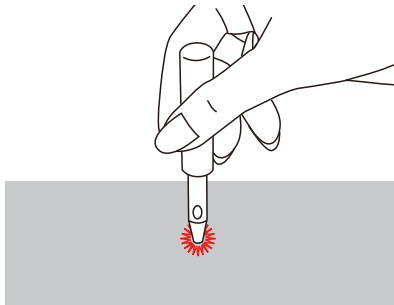
9.6 Sewing Eyelets



For increased stability sew the eyelet twice. Adjust stitch with the balance if necessary.

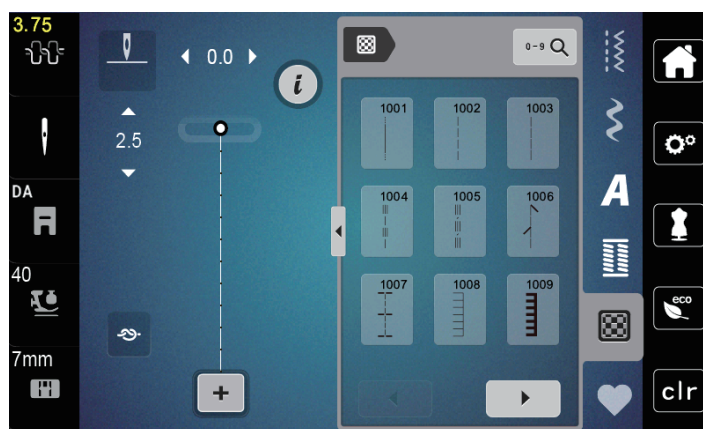











- > Attach the Zigzag Foot (DA) or the Embroidery Foot (JK) or the Open embroidery Foot (DN) (optional accessory).
- > Tap «Buttonholes».
- > Select the Eyelet Program No. 61 or No. 62.
- > To alter the size of the eyelet, turn the «Upper Multi-function Knob» or the «Lower Multi-function Knob».
- > Sew the Eyelet Program.
 - The machine stops automatically at the end of the Eyelet Program.
- > Use an awl, punch pliers or a hole punch to open the eyelet.



10 Quilting

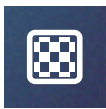
10.1 Overview Quilt Stitches



Stitch Pattern	Stitch Number	Name	Description
	1001	Quilting, Securing Program	To secure at the sewing start and sewing end with short stitches forward.
	1002	Quilting, Straight Stitch	Straight stitch 2 mm stitch length, to join patchwork parts.
	1003	Piecing Stitch/Straight Stitch	Straight stitch at 3 mm stitch length.
	1004	Handlook Quilt Stitch 1005, 1030, 1034, 1035	Imitation of handlook quilt stitch with monofilament.
	1006	Decorative Quilt Stitch Variations 1007, 1010-1012, 1015-1019, 1025-1027, 1031-1032	For "Crazy Patchwork" and embellishing.
	1008	Blanket Stitch	For appliqué and sewing on ribbons.
	1009	Double Blanket Stitch	For appliqué and sewing on ribbons.
	1013	Dual Blanket Stitch	To edgestitch between two appliqués, "Crazy Patchwork".
	1014	Double Blanket Stitch Dual	To edgestitch between two appliqués, "Crazy Patchwork".

Stitch Pattern	Stitch Number	Name	Description
	1020	Feather Stitch Variations 1021-1023	For "Crazy Patchwork" and embellishing.
	1024	Stippling Stitch/ Stippling Quilt Stitch	Imitation of stipple quilting.
	1029	Feather Stitch 1028, 1033	For "Crazy Patchwork" and embellishing.

10.2 Quilting, Securing Program



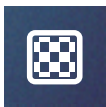
- > Attach the Zigzag Foot (DA).
- > Tap «Quilt Stitches».
- > Select Quilt Stitch Pattern No. 1001.
- > Press the foot control.
 - The machine sews 5 stitches forward automatically when sewing is started.



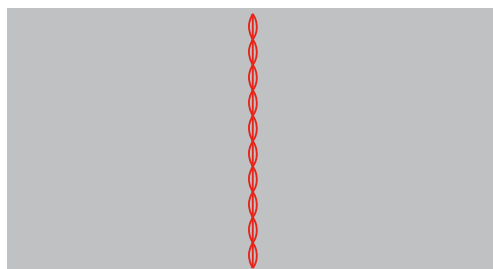
- > Sew the seam in the desired length.
- > Push the button «Securing Stitches».
 - The machine sews 5 stitches forward automatically and stops automatically at the end of the Securing Program.

10.3 Sewing Hand-look Quilt Stitches

Hand-look quilt stitches are suitable for all fabrics and sewing projects that should look like hand-sewn. It is recommended to use a monofilament thread for the upper thread and a cotton embroidery thread for the bobbin thread. The sewing speed should be moderate to prevent the monofilament from breaking. If required, the upper thread tension and the balance can be adjusted to the sewing project and the desired quilt stitch.



- > Attach the Embroidery Foot (JK) / Zigzag Foot (DA).
- > Tap «Quilt Stitches».
- > Select the Hand Quilt Stitch No. 1004 or 1005.
- > If necessary, adjust the upper thread tension and the balance to suit the sewing project and the desired quilt stitch.
- > To start the machine, press the foot control or push the button «Start/Stop».



10.4 Guiding the Quilt Work Freely



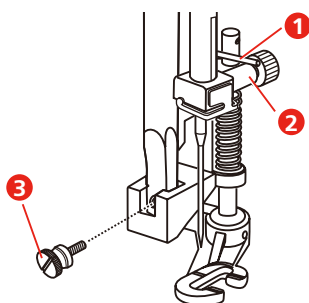
Quilting gloves with rubber nubs make it easier to guide the fabric.

It is recommended to use the extension table (optional accessory) and the Free Hand System. With free motion quilting, it is of advantage to quilt from the center outwards and to guide the fabric using smooth, round movements to form the design of your choice. Free motion quilting and darning are based on the same free motion principles.

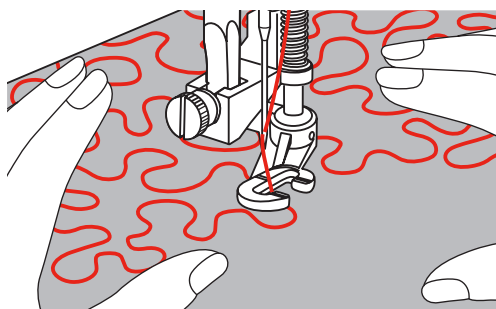
With stipple quilting, entire surfaces of the fabric are filled with quilt stitches. The single lines of stitching are rounded and never cross one another.

Prerequisite:

- The top layer, the batting and the backing are pinned together or basted.
- > Lower the feed dog.
- > Attach the Free-motion Embroidery Foot (RX) to the presser foot holder bar.
 - The pin (1) should rest on the upper side of the needle clamping screw (2).
- > Press the Free-motion Embroidery Foot (RX) firmly from below with your index finger and tighten the screw (3).



- > Tap «Practical Stitches».
- > Select Straight Stitch No. 1.
- > If necessary adjust the upper thread tension according to the sewing project.
- > To start the machine, press the foot control or push the button «Start/Stop».
- > Hold both hands close to the presser foot like an embroidery hoop to guide the fabric.
- > If the thread is lying on top of the fabric, slow down the movement.
- > If there are knots on the wrong side of the fabric, move the fabric more quickly.



11 Maintenance and Cleaning

11.1 Cleaning and Maintenance Intervals

To ensure the functionality and sewing quality of the machine, the machine must be cleaned and maintained regularly. The intervals for cleaning and maintenance of the machine depend on various factors, such as the fabrics and threads used.

As an advice to clean the machine, a message appears after 500,000 stitches.

As an advice to have the machine maintained, a message appears when 4,000,000 stitches have been sewn after a service.

11.2 Cleaning the Display

- > Clean the display when it is switched off with a soft slightly damp microfiber cloth.

11.3 Cleaning the Feed Dog

Remaining threads under the stitch plate must occasionally be removed.

- > Raise the needle and presser foot.



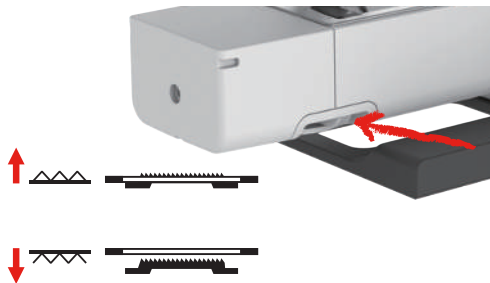
CAUTION

Electronically Driven Components

Risk of injury near the needle and the hook.

- > Switch the machine off and disconnect it from the power supply system.

- > Remove the needle and presser foot.
- > Lower feed dog.



- > Remove the stitch plate.

NOTICE

Dust and Thread Residues Inside the Machine

Damage to mechanical and electronic components.

- > Use a brush or a soft cloth.
 - > Do not use compressed air spray.
-
- > Clean the feed dog with the brush.

11.4 Cleaning the Hook



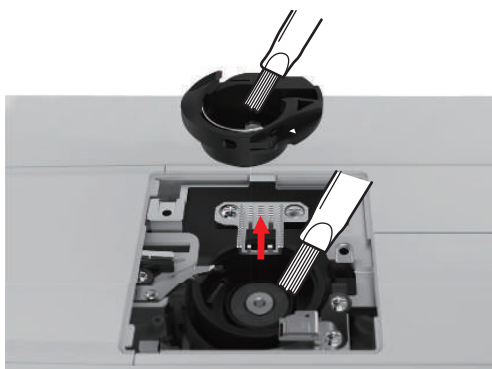
CAUTION

Electronically Driven Components

Risk of injury near the needle and the hook.

- > Raise the presser foot.
- > Switch the machine off and disconnect it from the power supply system.

- > Remove the presser foot and the needle.
- > Remove the stitch plate.
- > Clean the bobbin case with the brush.



- > Set needle to topmost position.
- > Remove the bobbin case.



- > Clean the shuttle race with the brush.
- > Insert the bobbin case.
 - Note:** The markings of the bobbin case and the stitch plate must be aligned identically.
- > Fit the stitch plate.
- > Fit the bobbin cover.
- > Fit the needle and presser foot.

11.5 Oiling the Needle Bar

The needle bar may not move smoothly without lubrication. If the machine is used frequently, the needle bar should be oiled every 6 months to prevent blocking.

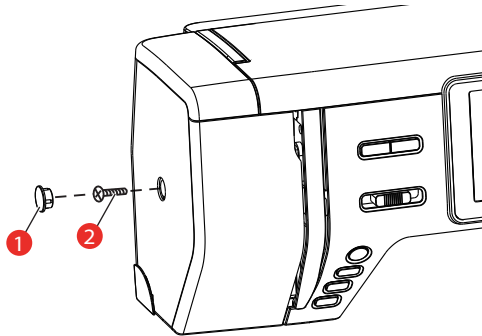


Electronically Driven Components

Risk of injury near the needle bar.

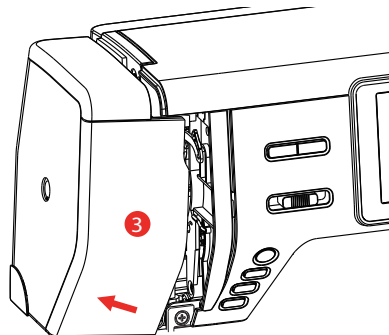
> Switch the machine off and disconnect it from the power supply system.

> Remove the protective cap (1) and screw (2).

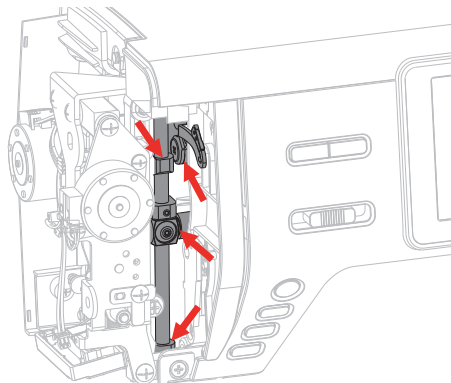


> Remove the headframe cover (3).

– After removing the headframe cover, pay attention to the moving parts.



> Apply a drop of oil to the movement mechanism of the needle bar, including the connecting rod/needle bar, needle bar holder and needle bar holder (apply oil to the points marked with an arrow).



> Remove the presser foot.

> Turn the handwheel a few times and remove any excess oil with a cloth.

> Attach the headframe cover again.

12 Errors and Faults



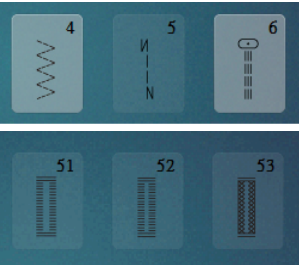
12.1 Troubleshooting


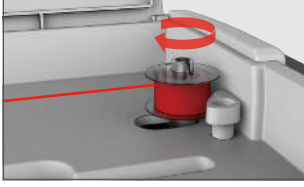
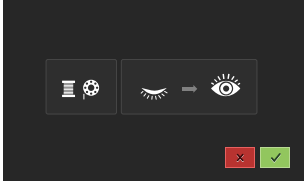
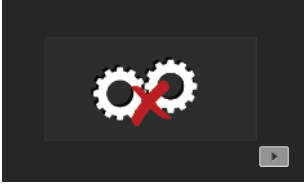

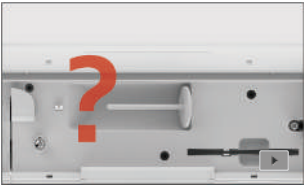

Fault	Cause	Repair
Uneven Stitch Formation	Upper thread too tight or too loose.	> Adjust the upper thread tension.
	Needle blunt or bent.	> Replace the needle, make sure that a new BERNINA quality needle is used.
	Poor quality needle.	> Use a new BERNINA quality needle.
	Poor quality thread.	> Use quality thread.
	Incorrect needle/thread combination.	> Match the needle with the thread size.
	Incorrectly threaded.	> Rethread.
	The fabric has been pulled.	> Feed the fabric evenly.
	Dust or thread remnants under the tension spring of the bobbin case.	> Remove any dust or thread remnants from under the tension spring of the bobbin case.
Skipped Stitches	Incorrect needle.	> Use the needle system 130/705H.
	Needle blunt or bent.	> Replace the needle.
	Poor quality needle.	> Use a new BERNINA quality needle.
	The needle is incorrectly inserted.	> Insert the needle with the flat side to the back as far up as it will go into the needle holder and tighten the screw.
	Incorrect needle point.	> Match the needle point to the texture of the material.
Faulty Stitching	Thread remnants between the thread tension discs.	> Fold a piece of thin material and slide the folded edge (not the raw edges) between the thread tension discs.
	Incorrectly threaded.	> Rethread.
	Thread is caught in the hook.	> Remove the upper thread and the bobbin case, turn the handwheel backwards and forwards by hand and remove the thread remnants.
	Incorrect needle/thread combination.	> Check the needle/thread combination.

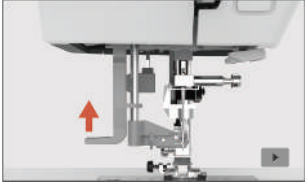
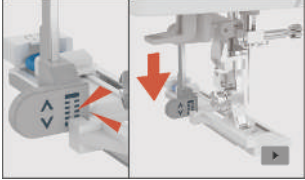

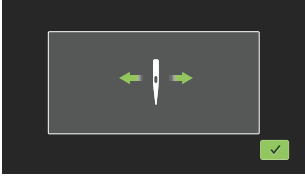
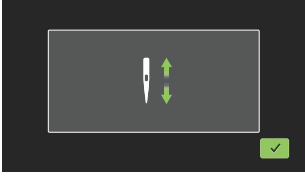

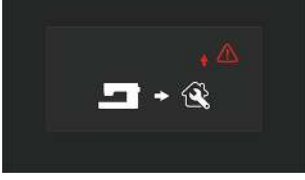
Fault	Cause	Repair
Upper Thread Breaks	Incorrect needle/thread combination.	> Match the needle with the thread size.
	Upper thread is too tight.	> Reduce the upper thread tension.
	Incorrectly threaded.	> Rethread.
	Poor quality thread.	> Use quality thread.
	The stitch plate or the hook tip is damaged.	> Contact a specialized bernette dealer to have the damages repaired. > Replace the stitch plate.
Lower Thread Breaks	The bobbin is not inserted correctly.	> Remove and reinsert the bobbin and pull on the thread. – The thread should run easily.
	Bobbin is wound incorrectly.	> Check bobbin and thread correctly.
	The stitch hole in the stitch plate is damaged.	> Contact a specialized bernette dealer to have the damages repaired. > Replace the stitch plate.
	Needle blunt or bent.	> Replace the needle.
Needle Breaks	The needle is incorrectly inserted.	> Insert the needle with the flat side to the back as far up as it will go into the needle holder and tighten the screw.
	The fabric has been pulled.	> Feed the fabric evenly.
	Thick fabric has been pushed.	> Use the appropriate presser foot, e.g. Jeans foot No. 8 for thick material. > Use the height compensating tool when sewing over a thick seam.
	Knotted thread.	> Use quality thread.
Display is Inactive	Incorrect calibrating data.	> Switch the machine off. > Switch the machine on and simultaneously press and hold down the buttons «Needle Left/Right». > Recalibrate the display.
	The eco Mode is active.	> Tap «eco Mode».
Stitch Width Not Adjustable	The selected needle and stitch plate cannot be used in combination.	> Replace the needle. > Replace the stitch plate.

Fault	Cause	Repair
Speed Too Low	Unfavorable room temperature.	> Place the machine in a warm room one hour before use.
	Settings in the Setup Program.	> Adjust the sewing speed in the Setup Program. > Adjust the slide.
The Machine doesn't Start	Unfavorable room temperature.	> Place the machine in a warm room one hour before use. > Connect the machine and switch it on.
	The machine is damaged.	> Contact the specialized bernette dealer.
The Light of the Button «Start-/Stop» doesn't Light Up	Light is defect.	> Contact the specialized bernette dealer.
Neither the Sewing Light Nor the Light on the Frearm Lights Up	Settings in the Setup Program.	> Activate it in the Setup Program.
	The sewing light is defect.	> Contact the specialized bernette dealer.
Upper Thread Indicator Fails to Respond	Settings in the Setup Program.	> Activate it in the Setup Program.
	The upper thread indicator is defect.	> Contact the specialized bernette dealer.
Bobbin Thread Indicator doesn't React	Settings in the Setup Program.	> Activate it in the Setup Program.
	The bobbin thread indicator is defect.	> Contact the specialized bernette dealer.

12.2 Error messages

Message on the Display	Cause	Repair
	This stitch number does not exist.	> Check the entry and enter the new number.
	Selection of stitch patterns not possible in combi-mode.	> Check the entry and enter the new number.
	The stitch number cannot be selected in combi mode.	> Select other stitches.

Message on the Display	Cause	Repair
	The selected needle and stitch plate cannot be used in combination.	<ul style="list-style-type: none"> > Check whether the correct needle and stitch plate are attached. > Exchange the needle and select it in the user interface. > Exchange the stitch plate and select it in the user interface.
	The winding unit is activated.	<ul style="list-style-type: none"> > Deactivate the winding unit.
	The thread indicator is deactivated.	<ul style="list-style-type: none"> > To switch on both thread indicators, tap «Confirm». > To keep the thread indicators switched off, tap «Cancel».
 	The main motor is not running.	<ul style="list-style-type: none"> > Turn the handwheel clockwise until the needle is at its top position. > Remove the stitch plate. > Remove the thread remnants. > Clean the hook. > Remove the hook and make sure that there are no pieces of broken needle points on the magnetic back of the hook.
	The upper thread is used up.	<ul style="list-style-type: none"> > Insert a new thread spool. > Rethread.
	The upper thread has broken.	<ul style="list-style-type: none"> > Rethread.
	The bobbin thread is used up.	<ul style="list-style-type: none"> > Remove the empty bobbin, wind it again and reinsert it.

Message on the Display	Cause	Repair
	<p>The threader lever is not raised.</p>	<ul style="list-style-type: none"> > Raise the threader lever.
	<p>The buttonhole lever does not touch the buttonhole foot with slide (RJ).</p>	<ul style="list-style-type: none"> > Pull the buttonhole lever down as far as possible until it engages behind the bracket.
	<p>The buttonhole lever is not pulled down. The feed dog is lowered.</p>	<ul style="list-style-type: none"> > Pull the buttonhole lever down as far as possible until it engages behind the bracket. > Raise the feed dog.
	<p>The needle moves sideways.</p>	<p>When the stitch plate is exchanged, this illustration appears because the needle is likely to move.</p>
	<p>The needle moves upwards.</p>	<ul style="list-style-type: none"> > Check whether there are any external objects near the stitch plate. > To raise the needle, tap «Confirm».
	<p>500,000 stitches have been sewn with the machine since the last cleaning advice.</p>	<ul style="list-style-type: none"> > Clean the machine. > For reference to cleaning to be made again after switching on the machine, tap «Cancel».
	<p>The machine has reached a stitch count of 4,000,000 since the last maintenance by a bernette dealer.</p>	<ul style="list-style-type: none"> > Contact your specialized bernette dealer to have the machine maintained. > For reference to maintenance to be made again after switching on the machine, tap «Cancel».

13 Technical data

Designation	Value	Unit
Sewign Light (LED)	300, 2	mA, Watt
Maximum Speed	Sewing Mode: 1000	Stitches per Minute
Measurements (w × d × h)	509 x 200 x 315	mm
Weight	Machine: 9.21 Accessory Box: 0.46	kg
Energy Consumption	90	W
Input Voltage	100 – 240	V
Protection Class (Electrical Engineering)	Protection Class II	

14 Appendix

14.1 Overview Stitch Patterns

Practical Stitches

1	2	3	4	5	6	7	8	9	10	11
12	13	14	15	16	17	18	19	20	21	22
23	24									

Buttonholes

51	52	53	54	55	56	57	58	59	60	61
62	63	64	66	69	71					

Decorative stitches

Satin Stitches

101	102	103	104	105	106	107	108	109	110	111
112	113	114	115	116	117	118	119	120	121	122
123	124									

Cross Stitches

125	126	127	128	129	130	131	132			
















Nature Stitches

133	134	135	136	137	138	139	140	141	142	143
144	145	146	147	148	149	150	151	152	153	




































Geometric Stitches

154	155	156	157	158	159	160	161	162	163	164
165	166	167	168	169	170	171	172	173	174	175
176	177	178	179	180	181	182	183	184	185	186
187	188	189	190	191	192	193	194	195	196	197
198	199	200	201	202	203	204	205	206	207	208
209	210	211	212	213	214	215	216	217	218	

Children Stitches

219	220	221	222	223	224	225	226	227	228	229
										
230	231	232	233							
										

Quilt Stitches

1001	1002	1003	1004	1005	1006	1007	1008	1009	1010	1011
										
1012	1013	1014	1015	1016	1017	1018	1019	1020	1021	1022
										
1023	1024	1025	1026	1027	1028	1029	1030	1031	1032	1033
										
1034	1035									
										

Index

A

Adjusting the Presser Foot Position via the Knee Lifter of the Free Hand System.....	29
Adjusting the Upper Thread Tension	43
Alphabets	80
Attaching the Knee Lifter of the Free Hand System	24
Attaching the Presser Foot Sole.....	29
Attaching the Seam Guide	30

B

Buttonholes	82
-------------------	----

C

Calibrating the Display	50
Calling up the Creative Consultant.....	52
Changing the Needle	31
Changing the Presser Foot	29
Changing the Presser Foot Holder	29
Changing the Stitch Plate.....	32
Checking the Firmware Version.....	50
Checking the Stitch Plate in the User Interface	33
Cleaning the Feed Dog	92
Cleaning the Hook.....	93
Combination Mode.....	60

D

Decorative Stitches.....	78
Dual Feed	55

E

Environmental Protection	9
Error Messages	97
Explanation of Symbols.....	10

F

Fabric Thickness Measurement.....	47
Feed Dog Up/Down	28
Foot Control	
Connecting	23

H

Height Compensating Tool	76
--------------------------------	----

I

Indicating the Presser Foot Sole in the User Interface.....	30
Inserting the Spool.....	27
Inserting the Spool Cap	25

M

Maintenance and Cleaning	92
--------------------------------	----

N

Needle Stop Up/Down (Permanent).....	32
Needle, Thread, Fabric	19
Needle/Thread Combination	22
Needles Overview	19

O

Overview of the Stitch Patterns	101
---------------------------------------	-----

P

Power Cable	23
USA/Canada	23
Practical Stitches	65
Preparing the Threading	34
Removing the Presser Foot Sole	29
Programming the Securing Stitches.....	43

Q

Quilting	89
----------------	----

R

Raising/Lowering the Needle	25
Regulating the Speed.....	25, 56
Restoring the default settings	50
Reverse Sewing.....	46

S

Safety Instructions	6
Saving a Stitch Pattern Combination	63
Second Spool Pin	26
Selecting a Stitch Pattern	54
Setting the Display Brightness	49
Setting the Display Color	48
Setting the Lower Thread Indicator	49
Setting the Presser Foot Pressure.....	31

Setting the Sewing Light	49
Setting the Upper Thread Indicator	48
Sewing Corners	77
Slide-on Freearm Extension Table	28
Sound On/Off	49

T

Technical Specifications	100
Threading the Bobbin Thread	41
Threading the Twin Needle	37
Threading the Upper Thread	34
Troubleshooting	95

U

Using eco Mode	52
Using the Spool Net	26

W

Winding the Bobbin Thread	39
---------------------------------	----



www.mybernette.com/b77

2023-06 EN
5020077.40A.04
© BERNINA International AG
Steckborn CH, www.bernina.com