

Basic Quilting Guide

– Making a Quilt –

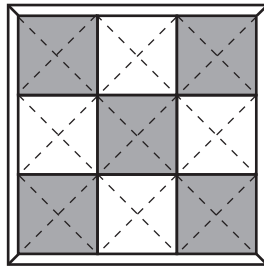

1 Preparing Materials and Equipment

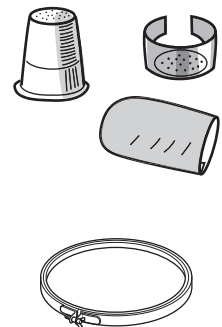

- Fabric We recommend 100% cotton that is not too thick.
- Quilt batting Normally, medium-thick 100% polyester batting is used. There is also cotton batting.
- Thread Since there are various types, for example, for piecing, for quilting, for hand-sewing and for machine-sewing, select the type appropriate for the desired purpose and use.
- Sewing needles/pins..... Since there are various types, for example, for piecing and for quilting, select the type appropriate for the desired purpose.
- Quilting pencil (erasable pen, etc.) ... Use to copy patterns onto fabric and to draw quilting lines.
- Thimble Use to protect your fingers when quilting.
Place a thimble on the middle finger of your right hand to push the needle and on the middle or index finger of your left hand to stop the needle.
- Quilting hoop Use the hoop for quilting with a cleaner finish.
- Thread clipper
- Iron/press
- Measuring stick



2 Cutting Pieces (Fabric)

Refer to “Cutting Around Drawings” in the Operation Manual to specify a seam allowance and draw the pattern lines, and then cut out the pieces. Be sure to observe the following instructions.

1 Check the fabric grain (weaving direction).

-  Lengthwise-grain fabric Hard to stretch
-  Crosswise-grain fabric Slightly stretched
-  Bias-grain fabric Easy to stretch

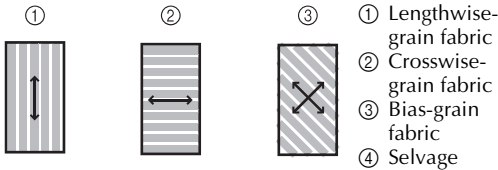
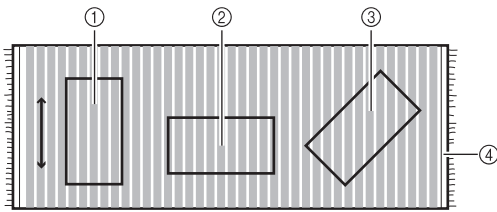

- * When making pieces from patterned fabric, the pattern has priority over the fabric grain.
- * Observe the fabric grain on the pattern if it is indicated.

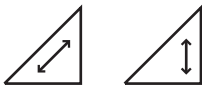

2 If a seam allowance will be drawn, attach the fabric with the wrong side facing up. Align the lengthwise grain with the insertion direction.

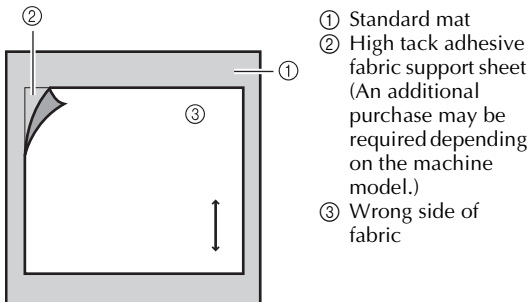

- ① Standard mat
- ② High tack adhesive fabric support sheet (An additional purchase may be required depending on the machine model.)
- ③ Wrong side of fabric

3 Select the patterns, and then arrange them. If the fabric grain and pattern angle are not aligned, rotate the pattern.

- * Pre-installed patterns will automatically be arranged with their grain along the lengthwise grain of the fabric.

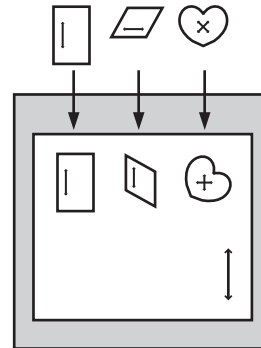

4 Specify the seam allowance.

- Widths that can be specified with this machine: 3 mm, 5mm, 1/4", 7mm, 10mm, 1/2", 5/8"

Standard seam allowance

Patchwork	5 mm (3/16"), 1/4", 7 mm
Appliqué	3 mm (1/8"), 5 mm (3/16")

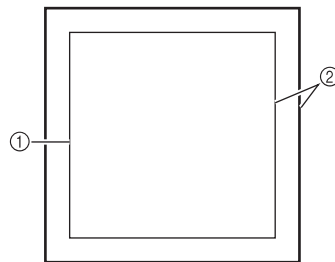

- ① Stitching line
- ② Seam allowance

3 Basic Hand Sewing Techniques



Memo

- If you are using a sewing machine to make the quilt, refer to your machine's instruction manual for information about the straight stitch, reverse/reinforcement stitch and appliqué stitch. When sewing pieces together without sewing reverse/reinforcement stitches, sew fine stitches, which have a short stitch length.

Thread knot

Make a knot at the end of the thread to secure it.

- 1 Wind the thread 2 or 3 times around the needle.

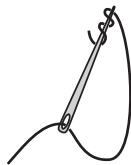

- 2 Hold the wound thread and pull out the needle.

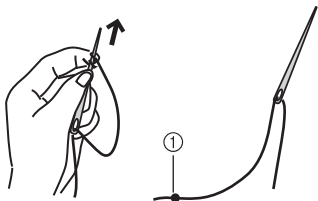

① Thread knot

- 3 Use scissors to cut off any excess thread.

Running stitch

Sew fine stitches when sewing pieces together.

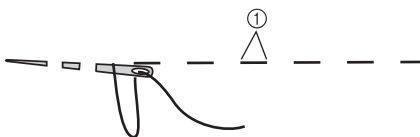

① 2 mm (1/16 inch)

Blindstitch

Attach appliqués so that threads are imperceptible.

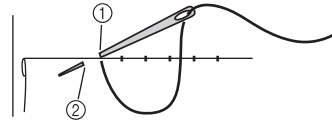

- ① Insert the needle
- ② Feed out the needle

Backstitch

At the beginning and end of stitching, sew one backstitch, and then secure the thread to prevent it from becoming loose.

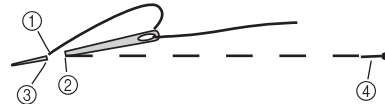

- ① Feed out the needle
- ② Insert the needle
- ③ Feed out the needle
- ④ Backstitch

French knot

At the end of stitching, sew a backstitch, make a knot, and then cut the thread.

- 1 Place the needle at the end of stitching.

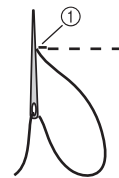

① Backstitch

- 2 Wind the thread twice around the needle, hold the wound thread with your finger, and then pull out the needle.

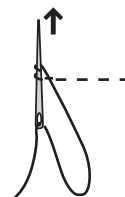

Seam starting or ending point

When sewing pieces together, sew to the corner of the stitching line.

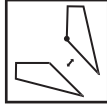

- 1 Sew the pieces together. At the beginning of stitching, make a knot in the thread, insert the needle in front of the stitching line, and then sew one backstitch.

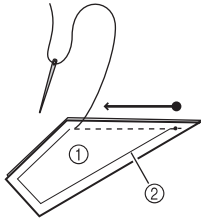

- ① Wrong side of fabric
- ② Stitching line

- 2 At the end of stitching, sew one backstitch, and then make a french knot at the corner.

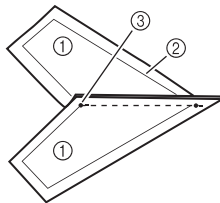
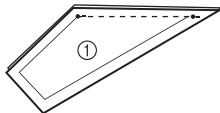
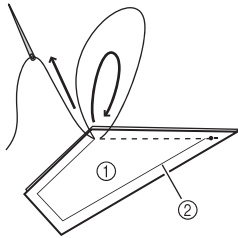

- ① Wrong side of fabric
- ② Stitching line
- ③ End point

Set in seam

Continuously sew together multiple pieces of fabric by sewing each side without cutting the thread.



▨: Right side of fabric

□: Wrong side of fabric

- 1 Sew pieces A' and B together. At the end point, pass the needle to the opposite side of A'.

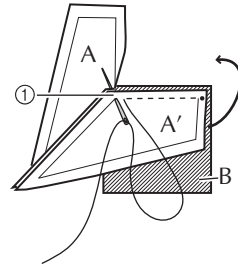

- ① End point

- 2 Feed the needle out to the end point of A.

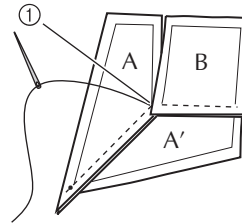

- ① Start point

- 3 Overlap A and B, and then continue sewing.

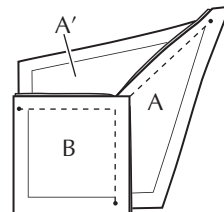
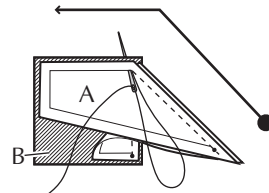

4 Sewing Pieces Together to Make the Top (Patchwork)

Using two types of fabric, prepare 4 square pieces from one and 5 from the other. (Refer to the illustration below.)
Cut the pieces with a seam allowance.

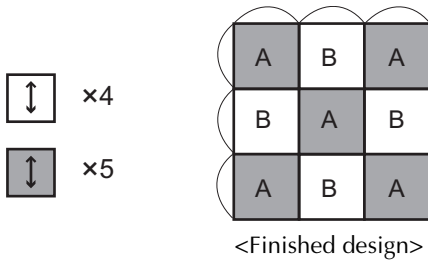

Sewing order

- 1 Sew pieces together into rows.**
Fold over seam allowances in alternating directions.

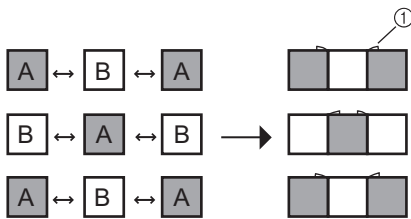

① Seam allowance

- 2 Sew the rows together to complete it.**

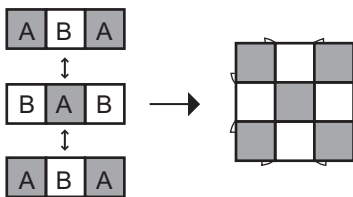

Sewing method

- 1 Align the pieces with their right sides together, and then pin them.**
At the beginning of stitching, insert the needle one stitch in front of the stitching line.

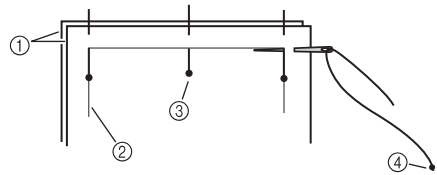

- ① Right sides together
- ② Stitching line
- ③ Pin
- ④ Thread knot

- 2 Sew one backstitch, and then continue sewing a running stitch.**

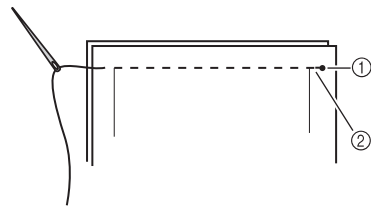

- ① Thread knot
- ② Backstitches

- 3 At the end of the stitching, sew one backstitch.**

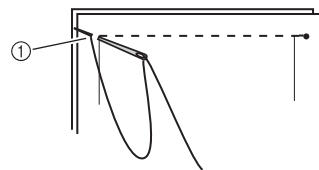

- ① Backstitches

- 4 Make a French knot.**

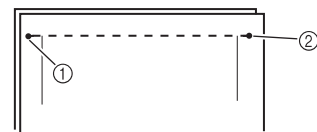

- ① French knot
- ② Thread knot

Sewing appliqués

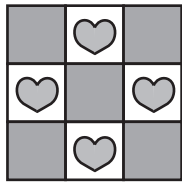

<Finished design>

- 1 Cut the appliqué pieces with a seam allowance applied.
(Example: 4 hearts)
- 2 Make cuts 1 mm (1/16 inch) from the stitching line.

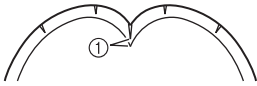

① 1 mm (1/16 inch)



Note

- Make more cuts in tight curves.

- 3 Place the pattern on the appliqué piece, and then fold over the seam allowance using an iron or press.

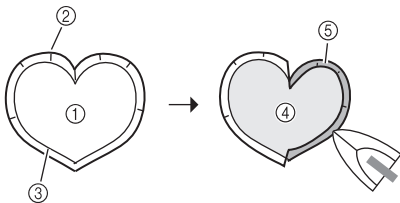

- ① Wrong side of fabric
- ② Cut
- ③ Stitching line
- ④ Pattern
- ⑤ Right side of fabric

- 4 Mark the base fabric.

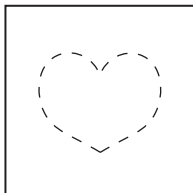

- 5 Remove the pattern, and then place the appliqué piece on the base fabric.

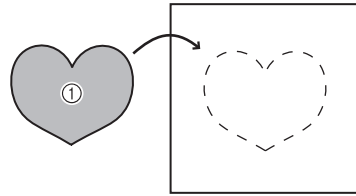

① Right side of fabric

- 6 Attach the appliqué piece to the base fabric with blindstitching.

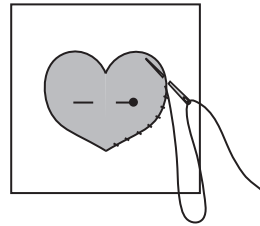

5 Drawing Quilting Lines

After the top (patchwork) is finished, draw the quilting lines.
Use a quilting pencil or erasable pen to lightly draw the lines.
Draw with a light color on dark fabric.

Sample quilting lines

Diagonal grid

Quilt a diagonal grid. This is frequently used to securely sew the fabric together.

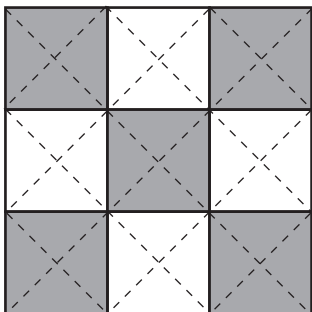

Diagonals

Quilt parallel diagonal lines.

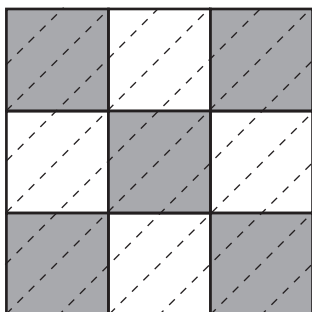

In-the-ditch

Quilt at the edge of the pieces on the sides where the seam allowance was not folded onto.

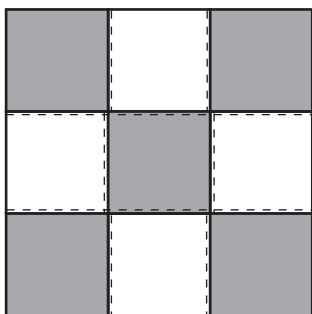

Outline

Quilt 3 to 4 mm (1/8 to 3/16 inch) inside the edge of each piece.

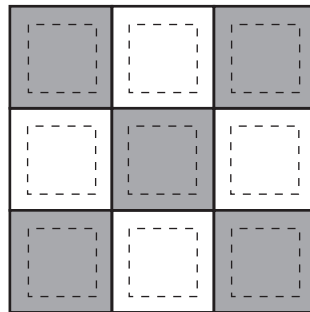

Grid

Quilt a vertical and a horizontal line through the center of each piece.

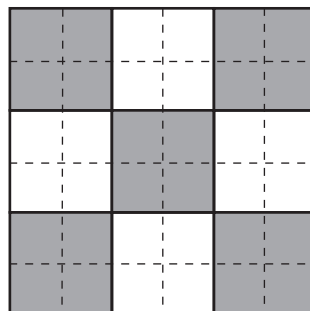

Block

Quilt patterns.

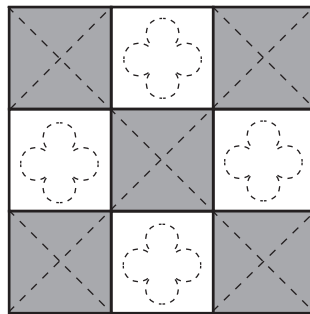

6 Basting

After drawing the quilting lines, overlap the backing fabric, quilt batting and top (patchwork), in order, and then baste them together.

- 1 Prepare quilt batting and backing fabric 3 to 4 cm (1-3/16 to 1-9/16 inches) larger than the top, overlap the three layers, and then secure them with pins.**

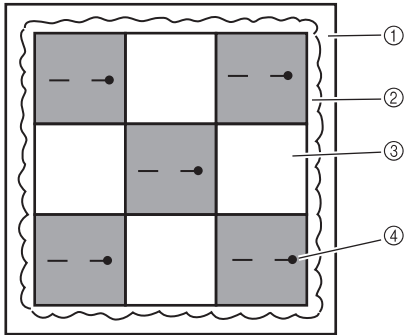

- ① Wrong side of fabric
- ② Quilt batting
- ③ Top
- ④ Pin

- 2 From the center to the outside, baste a grid pattern in the order shown in the illustration. At the beginning of stitching, make a thread knot. At the end of stitching, sew a backstitch, and then cut the thread.**

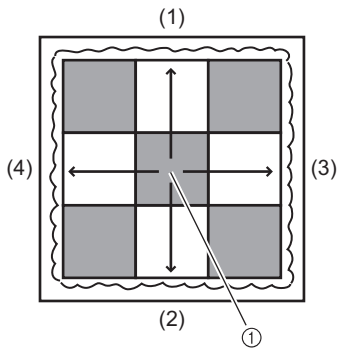

- ① Beginning of stitching

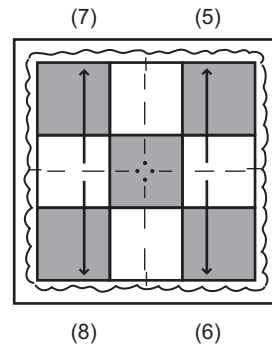

(8) (6)

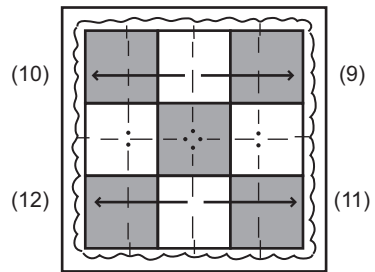

(12) (11)

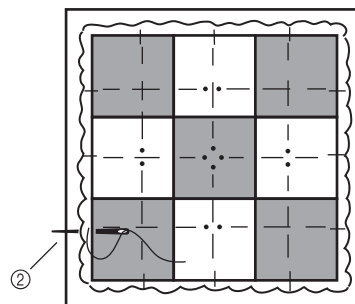

- ② Backstitch

* When quilting small items, basting pins can also be used.

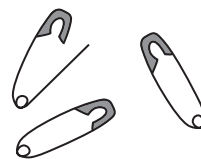

7 Quilting

Quilting order

From the center to the outside, sew symmetrically in the order shown in the illustration.

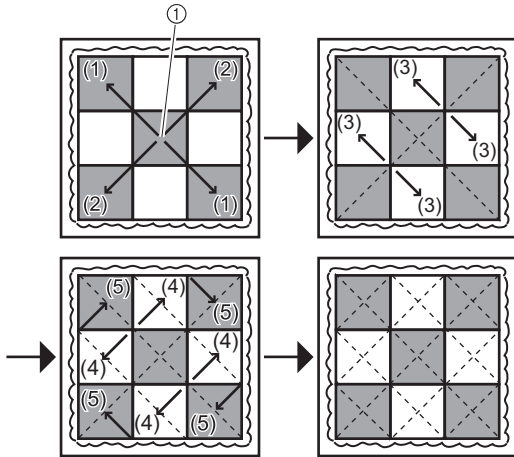

① Beginning of stitching

Beginning stitching

- 1 Insert the needle a short distance from the beginning, and then pull the thread to bring the knot between the top and backing fabric in order to hide it.

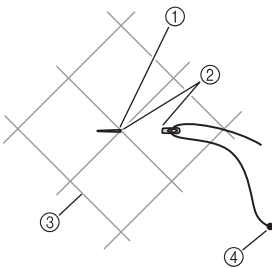

- ① Start of quilting
- ② 2 to 3 cm (3/4 to 1-3/16 inches)
- ③ Quilting lines
- ④ Thread knot
- ⑤ The thread knot is inside.

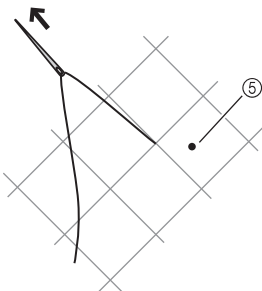

- 2 At the beginning of stitching, sew one backstitch.

Be sure to pass the needle through the three layers (top, quilt batting and backing fabric) when quilting.

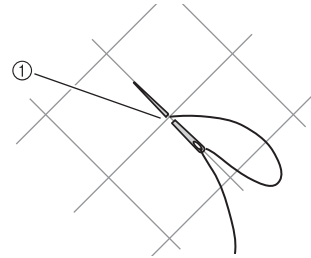

① Backstitch

Ending stitching

- 1 Sew one backstitch, make a french knot, and then insert the needle into the same hole again to bring the knot between the top and backing fabric in order to hide it.

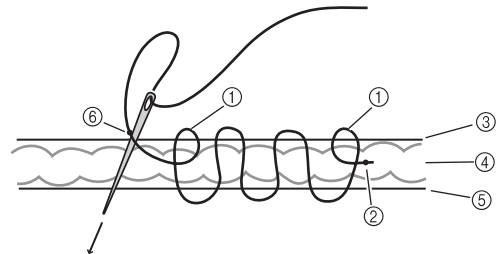

- ① Backstitches
- ② Thread knot
- ③ Top
- ④ Quilt batting
- ⑤ Back of fabric
- ⑥ French knot

- 2 After quilting and removing the basting stitching, cut off the excess backing fabric and quilt batting, leaving for the bias tape a finished width of 7 mm (1/4 inch) from the edge of the top (patchwork).

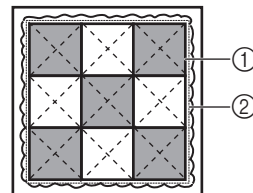

- ① Top (patchwork)
- ② Cut off, leaving for the bias tape a finished width from the edge of the top.

8 Binding (Finishing Fabric Edges)

After quilting, cover the edges with bias tape to finish them.

Making bias tape

Make bias tape with a finished width of 7 mm (1/4 inch).

Draw a 35-mm-wide (1-3/8 inches) strip at a 45° angle on the fabric, and then cut it out.

Draw a line 7 mm (1/4 inch) from the edge of the bias tape.

Sew the strips together to a length of 15 to 20 cm (6 to 8 inches) plus the length of the four sides of the quilt.

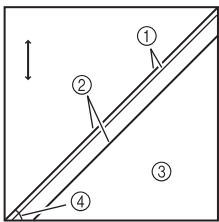

- ① 7 mm (1/4 inch)
- ② 35 mm (1-3/8 inches)
- ③ Wrong side of fabric
- ④ 45°

Connecting bias tape sections

With their right sides together, align the ends of two sections, and then sew them together with 7 mm (1/4 inch) seam allowance.

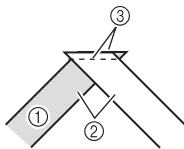

- ① Right side of fabric
- ② Right sides together
- ③ 7 mm (1/4 inch)

Binding

- 1** Align the 7 mm (1/4 inch) line with the stitching line of the quilt, and then sew. Fold over 1 cm (3/8 inch) of the end of the bias tape.

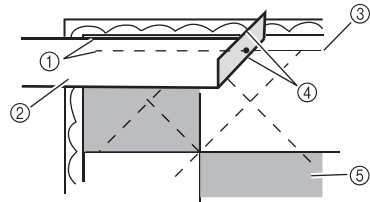

- ① 7 mm (1/4 inch)
- ② Wrong side of bias tape
- ③ Stitching line
- ④ Fold over 1 cm (3/8 inch).
- ⑤ Right side of quilt

- 2** At the corner, fold the bias tape out at a 45° angle.

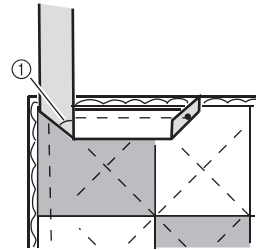

- ① 45°

- 3** As shown in the illustration, fold it at a 90° angle, and then sew along the 7 mm (1/4 inch) line.

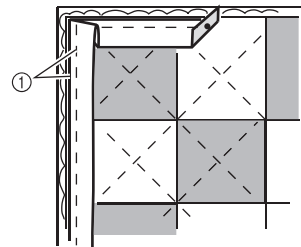

- ① 7 mm (1/4 inch)

- 4** In the same way, sew all along the edges and return to the folded back end of the bias tape. Cut off any excess bias tape.

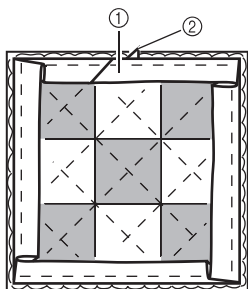

- ① Overlap the fold.
- ② Excess bias tape

- 5** Turn the quilt over, cover the seam allowance with the bias tape, and then finish it with blindstitching. The corner will be mitered as shown in the illustration.

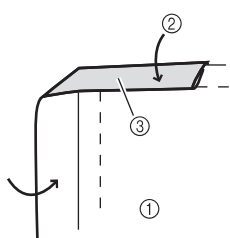

- ① Wrong side of fabric
- ② Fold in three
- ③ Right side of bias tape

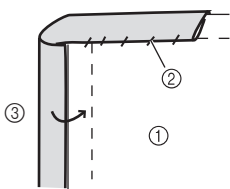

- ① Wrong side of fabric
- ② Blindstitch
- ③ Fold in three

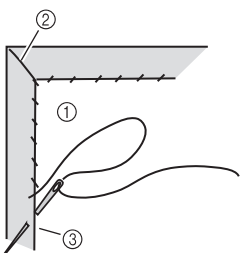

- ① Wrong side of fabric
- ② Mitered
- ③ Blindstitch

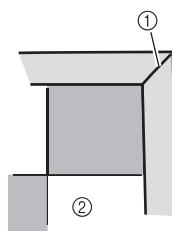

- ① Mitered
- ② Right side of quilt



Memo

- Binding sewn with a sewing machine will be securely attached. With binding sewn by hand, secure with a half-backstitch.

