



BERNINA 700

User Manual

Table of Contents

IMPORTANT SAFETY INSTRUCTIONS	7	2.3 Connection and Switching On	31
Important Information	9	Connecting the foot control (Optional accessory)	31
1 My BERNINA	11	Connecting the Machine	31
1.1 Introduction	11	Fixing the Touch Screen Pen	32
1.2 BERNINA Quality Control	11	Switching the Machine On	32
1.3 Welcome to the World of BERNINA	11	Switching on the sewing light	32
1.4 Overview Machine	13	2.4 Foot control (Optional accessory)	32
Overview front controls	13	Regulating the speed via the foot control	32
Overview front	14	Raising/Lowering the needle	33
Overview sideways	15	2.5 Spool Pin	33
Overview - Back Panel	16	Swiveling Spool Pin	33
Overview Embroidery module	17	Horizontal Spool Pin	34
1.5 Supplied Accessories	18	Attaching the multiple-spool holder	34
Overview Accessories Machine	18	2.6 Embroidery foot	34
Accessory box	20	Adjusting the Presser Foot Position via the Button «Presser Foot Up/Down»	34
Overview Accessory Embroidery Module	21	Attaching the embroidery foot	34
1.6 Overview User Interface	22	Selecting the Stitch Plate in the User Interface	35
Overview Functions and Views	22	2.7 Needle and Stitch Plate	35
Overview System settings	22	Inserting the embroidery needle	35
Overview Selection menu	22	Selecting the needle in the User Interface	36
Software Operation	23	Selecting needle type and needle size	36
1.7 Needle, Thread, Fabric	25	Attaching the stitch plate	37
Overview Needles	25	Selecting the stitch plate in the User Interface	37
Example for Needle Description	26	2.8 Threading	37
Needle/Thread Combination	26	Threading the upper thread	37
Upper Thread	26	Winding the bobbin thread	40
Bobbin Thread	27	Threading the Bobbin Thread	41
1.8 Important Embroidery Information	27	Thread-up Command	43
Choosing the Embroidery Design	27	Indicating Fill Level of Bobbin Thread	43
Selecting the Embroidery File Format	27	2.9 Attaching the Module	43
Embroidery Test	28	2.10 Selecting the embroidery motif	44
The Size of the Embroidery Design	28	2.11 Embroidery Hoops	44
Embroidering Designs by Third-party Providers	28	Overview Embroidery Hoop Selection	44
Underlay Stitches	28	Selecting the Embroidery Hoop	45
Satin or Leaf Stich	28	Tear-away Stabilizers	45
Step Stitch	29	Cut-away Stabilizers	45
Connecting Stitches	29	Using Adhesive Spray	45
2 Embroidery Preparation	30	Using Spray Starch	45
2.1 Before Using the Machine for the First Time	30	Using Iron-on Interfacing	45
2.2 Accessories Box	30	Using Paper-backed Adhesive Stabilizer	46
Accessory box free standing	30	Using Water-soluble Stabilizer	46
Storing accessory	30	Preparing the Embroidery Hoop	46
		Attaching the Hoop	47
		Overview embroidery functions	48



Centering the embroidery hoop to the needle	48	5.4	Regulating the Speed	59
Moving the hoop to the back	48	5.5	Editing the Embroidery Design	60
Moving the embroidery arm to the left	48		Overview Editing embroidery motif	60
Grid On/Off	49		Scaling Up the Embroidery Design View	60
Locating the center of the embroidery motif	49		Downsizing the Embroidery Design	60
Virtual Positioning of the Embroidery Hoop	49		Moving the Embroidery Design View	60
3 Setup Program	50		Moving the Embroidery Design in Enlarged View	61
3.1 Embroidery Settings	50		Moving the Embroidery Design	61
Adjusting the Upper Thread Tension	50		Rotating the Embroidery Design	61
Adjusting the Maximum Embroidering Speed	50		Altering the Embroidery Design Size Proportionally	62
Centering or opening embroidery motifs in the original position	50		Altering the Embroidery Design Size Disproportionally	62
Calibrating the embroidery hoop	50		Mirroring Embroidery Designs	63
Entering the fabric thickness	51		Changing the Stitch Type	63
Activating/Deactivating the function thread away	51		Altering the Stitch Density	63
Programming the securing stitches	51		Checking the embroidery motif size and position	64
Adjusting the thread cut	52		Endless Embroidery	64
Changing the measuring unit	53		Duplicating the embroidery motif	66
3.2 Selecting personal settings	53		Deleting an Embroidery Design	66
3.3 Monitoring Functions	53		Changing the sequence within an embroidery motif combination	66
Activating the Upper Thread Indicator	53		Undoing entries	67
Activating the Bobbin Thread Indicator	53	5.6	Grouping embroidery motifs	67
3.4 Activating the audio signals	54		Pinpoint Placement	68
3.5 Machine Settings	54		Positioning of grid points	68
Selecting a language	54		Free point positioning	69
Adjusting the Brightness of the Display	54	5.7	Combining Embroidery Designs	70
Adjusting the Sewing Light	55		Combining Embroidery Designs	70
Calibrating the Display	55		Deleting a Single Embroidery Design	70
Back to basic setting	55		Duplicating the embroidery motif	70
Deleting user data	55		Duplicating a combination	71
Deleting motifs on the BERNINA USB Stick	56	5.8	Creating Lettering	71
Packing the embroidery module	56		Overview embroidery alphabets	71
Reviewing the total number of stitches	56		Creating Lettering	73
Registering details of the dealer	56		Editing the Lettering	73
Saving Service data	57	5.9	Changing the Colors of the Embroidery Design	74
4 System Settings	58		Overview changing the color	74
4.1 Calling up the tutorial	58		Changing the colors	74
4.2 Calling up the Embroidery Consultant	58		Altering the colors via the color wheel	74
4.3 Calling Up the Help	58		Changing the Thread Brand	75
4.4 Using eco mode	58	5.10	Embroidering the Embroidery Design	76
4.5 Cancelling Any Alterations with «clr»	58		Overview Embroidery menu	76
5 Creative Embroidering	59		Adding Basting Stitches	76
5.1 Overview Embroidering	59		Moving the Hoop	76
5.2 Selecting and Changing the Embroidery Design	59		Embroidery sequence control when thread breaks	76
5.3 Checking the Embroidery Time and the Embroidery Design Size	59		Cutting Connecting Stitches	77
			Reducing Color Changes	77
			Multi-colored Embroidery Design On/Off	77
			Endless Embroidery	77
			Color Indication	78
		5.11	Freearm Embroidery	78

5.12	Administering Embroidery Designs	79	Borders and Lace	101
	Administering Embroidery Designs	79	Children	104
	Saving Embroidery Designs in the Personal Memory	79	Flowers	107
	Saving the Embroidery Design on the BERNINA USB Stick	80	Seasons	110
	Overwriting the Embroidery Design in the Personal Memory	80	Embellishment	112
	Overwriting the Embroidery Design on the BERNINA USB Stick	80	Sport and Hobbies	115
	Loading an Embroidery Design from the Personal Memory	80	Asia	117
	Loading an Embroidery Design from the BERNINA USB Stick	81	Charming monograms	118
	Deleting an Embroidery Design from the Personal Memory	81	Animals	121
	Deleting an Embroidery Design from the BERNINA USB Stick	81	DesignWorks	123
			Monograms in pink	124
			Monograms in blue	127
6	Embroidery	82	Index	130
6.1	Embroidering via the button «Start/Stop»	82		
6.2	Increasing the Embroidery Speed	82		
6.3	Adjusting the upper thread tension	82		
6.4	Embroidering via the foot control (Optional accessory)	83		
7	Care and Maintenance	84		
7.1	Firmware	84		
	Restoring saved data	84		
	Checking the firmware version	84		
	Updating firmware	84		
7.2	Machine	85		
	Cleaning the Display	85		
	Removing thread remnants under the stitch plate	85		
	Cleaning the Hook	85		
	Lubricating the Hook	86		
	Cleaning the thread catcher	88		
8	Errors and Faults	89		
8.1	Error messages	89		
8.2	Troubleshooting	93		
9	Storage and Disposal	96		
9.1	Storing the Machine	96		
9.2	Dispose of the Machine	96		
10	Technical data	97		
11	Overview Stitch Patterns	98		
11.1	Overview Embroidery Desings	98		
	Editing the Embroidery Design	98		
	Projects	98		
	Quilt Designs	99		



Safety Instructions

- While operating the machine, all protective inserts must be in place and all covers must be closed.

Appropriate Use

- The machine may be used, cleaned and maintained by children older than eight or by people with reduced physical, sensory or mental capabilities or if there is a lack of experience and knowledge as long as they have been given instructions.
- Furthermore, these persons must be supervised while working with the machine, and/or they must know the safe operation of the machine and be aware of the resulting hazards.
- Children are not allowed to play with the system.
- Special care should be taken when the machine is operated by or in the presence of children.
- Only use the machine with the supplied power cable.
- USA and Canada only: Do not connect power plug NEMA 1-15 to circuits exceeding 150 volt-to-ground.
- Only use this machine with the supplied foot control of type LV-1.
- Do not insert any objects into the openings of the machine.
- Do not place any objects on the foot control.
- While sewing, guide the fabric gently. Pulling and pushing the fabric can cause needle breakage.
- Keep fingers away from all moving parts.
- Special care is required in the needle area.
- For activities in the needle area - such as threading the needle, changing the needle, threading the looper or changing the presser foot - switch off the machine.
- To switch off, set the power switch to «0».

- When protective covers are removed, when the machine is oiled or when other cleaning and maintenance operations mentioned in this instruction manual are carried out, switch off the machine and disconnect the power plug from the outlet.
- Pull the plug out of the outlet by pulling on the plug. Do not pull on the cable.

Safety Signs on the Machine

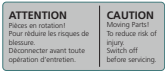
Safety signs	Purpose
	<p>Caution; moving parts.</p> <p>To reduce the risk of injury, switch off the machine before maintenance work.</p>



Explanation of Symbols

 DANGER

Designates a danger with a high risk which can lead to serious injuries or even death unless it is avoided.

 WARNING

Designates a medium-risk hazard which can lead to serious injuries if not avoided.

 CAUTION

Designates a low-risk hazard which can lead to minor or moderate injuries if not avoided.

NOTICE

Designates a hazard which can lead to material damage if not avoided.



Tips by BERNINA **Embroidery experts** can be found next to this sign.



BERNINA Blog



Subtle instructions, free cutting patterns and embroidery designs as well as many new ideas: All this you can find in the weekly blog of BERNINA. Our experts give useful tips and explain step by step how you can achieve the desired result. In the community you can upload your own projects and exchange experiences and ideas with other sewing and embroidering enthusiasts.

www.bernina.com/blog

Available in English, German, Dutch and French.

BERNINA Social Media



Follow on social networks to learn more about events, thrilling projects as well as tips and tricks all about sewing, quilting and embroidering. We will keep you informed and we are looking forward to presenting you the one or the other highlight from the world of BERNINA.

www.bernina.com/social-media

BERNINA App



Download the BERNINA App from the App Store to your smartphone and enjoy direct access to all product information. The accessory organizer gives you an overview of your accessories and those you still would like to have. Furthermore, you have direct access to the customer portal, the blog and the "inspiration" online store, and you can always find an authorized specialist dealer near you. The app is available in the Apple App Store and the Google Play Store. You will find direct links at: www.bernina.com/app



1.4 Overview Machine

Overview front controls



- | | | | |
|---|------------------------------------|----|-------------------------------|
| 1 | «Sewing Light On/Off» | 7 | «Check Embroidery Motif Size» |
| 2 | «Thread Cutter» | 8 | «Bobbin Thread Up» |
| 3 | «Presser Foot Up/Down» | 9 | «Upper Multi-function Knob» |
| 4 | «Start/Stop» | 10 | «Lower Multi-function Knob» |
| 5 | «Center Embroidery Hoop to Needle» | 11 | «Pinpoint Placement» |
| 6 | «Move Hoop to the Back» | 12 | «Center Motif» |

Overview front



- | | | | |
|---|--------------------------------------|----|-----------------------------------|
| 1 | Connection for the embroidery module | 6 | Slide speed control |
| 2 | Bobbin cover | 7 | Thread take-up lever cover |
| 3 | Embroidery foot | 8 | Thread take-up lever |
| 4 | Needle threader | 9 | Fixing screw |
| 5 | Sewing light | 10 | Connection for the slide-on table |

Overview sideways



- | | | | |
|---|---------------------------------|----|-------------------------------------|
| 1 | Connection for Foot Control | 7 | Power Switch |
| 2 | Service Connection | 8 | Connection for Power Cable |
| 3 | Spool Pin | 9 | Magnetic Holder for Touchscreen Pen |
| 4 | Winding Unit with Thread Cutter | 10 | Air Vents |
| 5 | Swiveling Spool Pin | 11 | USB Port |
| 6 | Handwheel | | |

Overview Embroidery module



- | | | | |
|---|--------------------------------|---|-----------------------------|
| 1 | Embroidery arm | 3 | Guide rails for the machine |
| 2 | Coupling for securing the hoop | 4 | Connection to the machine |



1.5 Supplied Accessories



You will find further information and application tips on the supplied and optional accessories at: <https://www.bernina.com/700#!accessories>

Overview Accessories Machine









Illustration	Name	Purpose
	Dust Cover	To protect the machine from dust and contamination.
	BERNINA Accessories Box	To store the supplied accessories as well as optional accessories.
	Multiple Spool Holder	For quick access to the thread spools and thread changes, e.g. for multicolored embroidery motifs. For a longer way to the needle and therefore to the option to untangle difficult threads before embroidering.
	Spool Cap	To support the regular unwinding of the thread from the spool.
	Bobbin for B9 Hook Set of 4	To wind the bobbin thread.
	Foam Pad 2 pieces	The foam pad prevents the thread from slipping, tangling or breaking on the spool pin.
	Touchscreen Pen	For precise operation of the touch screen.
	Seam Ripper	To undo seams and to cut buttonholes open.

Illustration	Name	Purpose
	Screwdriver Torx, gray	To change the needle.
	Screwdriver red (slot)	To loosen and tighten slotted screws.
	Angular Torx Wrench Torx	To open the headframe.
	Brush/Needle Inserter	To clean the feed dog and the looper area.
	Sewing Machine Oil	To oil the machine.
	Power Cable	To connect the machine with the power supply system.

Accessory box





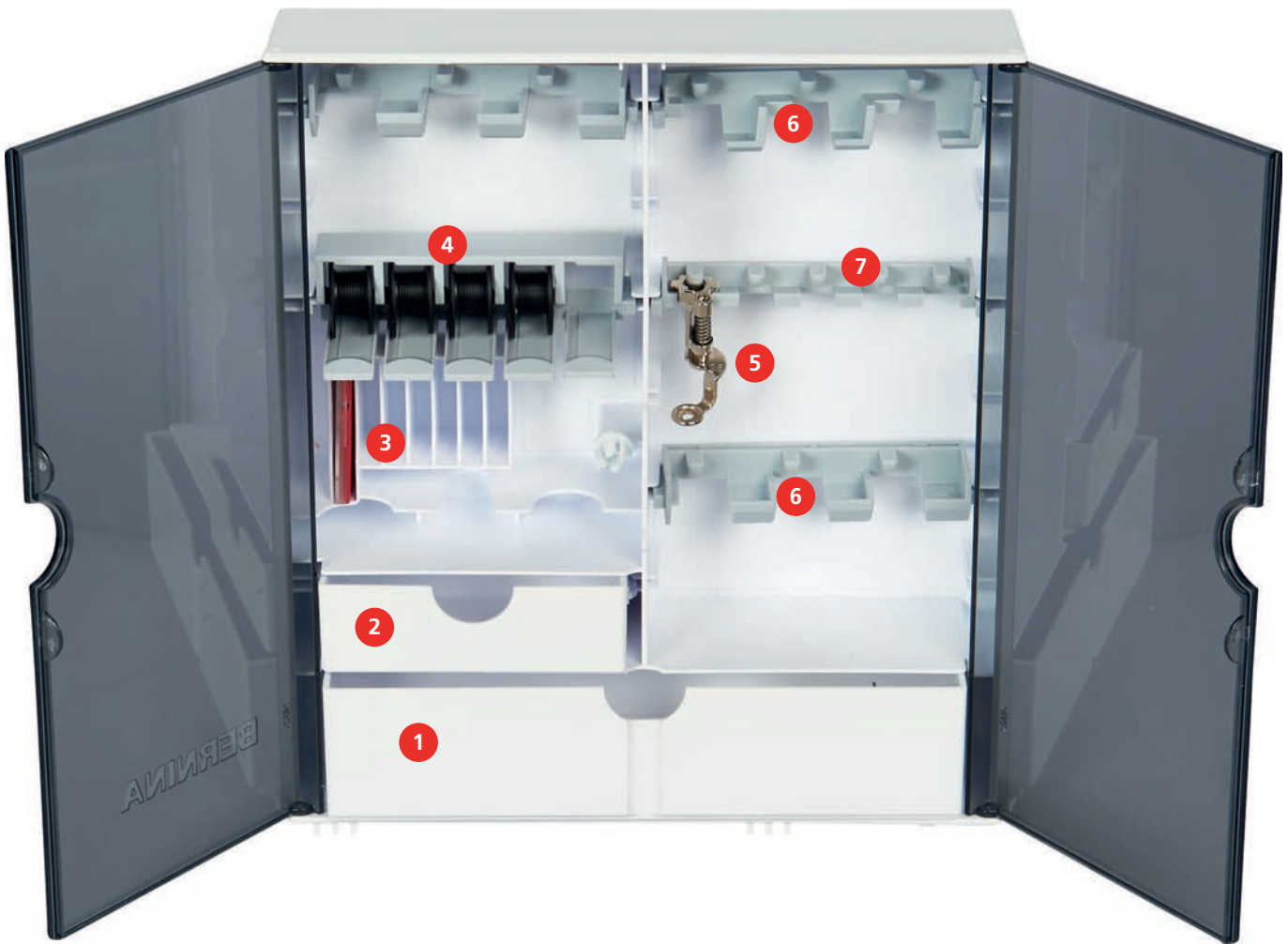



- 1 Big Drawer
- 2 Small Drawer
- 3 Needle Assortment
- 4 Spool Pin

- 5 Embroidery Foot
- 6 Holder for Embroidery Feet, 9.0 mm
- 7 Holder for Embroidery Feet, 5.5 mm



Overview Accessory Embroidery Module

Illustration	Name	Purpose
	Drop-shaped Embroidery Foot #26	For embroidering, darning and freehand quilting.
	Large Oval Embroidery Hoop	To embroider large embroidery designs or design combinations up to 145 x 255 mm (5.70 x 10.04 in). Template for precise fabric positioning included.
	Medium Embroidery Hoop	To embroider medium-sized embroidery designs up to 100 x 130 mm (3.94 x 5.12 in). Template for precise fabric positioning included.
	Small Embroidery Hoop	To embroider small embroidery motifs up to 72 x 50 mm (2.83 x 1.97 in). For free arm embroidering with closed sewing projects such as sleeves, trouser legs or socks. Including the template for precise fabric positioning.
	Embroidery Needle Assortment	For embroidering.
	Template Holder	To place and remove the template in or out of the embroidery hoop.
	Spool Net	For even thread unwinding with smooth threads from the thread spool, e.g. nylon, rayon, silk threads or metallic yarns.

1.6 Overview User Interface

Overview Functions and Views



- | | | | |
|---|---|---|------------------------------|
| 1 | «Upper Thread Tension» | 4 | «Hoop Indicator/Select Hoop» |
| 2 | «Needle Selection» | 5 | «Stitch Plate Selection» |
| 3 | «Presser Foot Indicator/Presser Foot Selection» | 6 | «Bobbin Thread» |

Overview System settings



- | | | | |
|---|-------------------------|---|------------------|
| 1 | «Home» | 5 | «Help» |
| 2 | «Setup Program» | 6 | «eco Mode» |
| 3 | «Tutorial» | 7 | «Clear Settings» |
| 4 | «Embroidery Consultant» | | |

Overview Selection menu

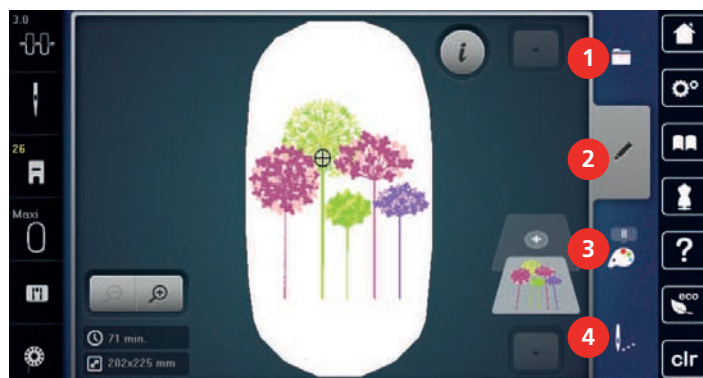

- | | | | |
|---|-------------|---|---------------------|
| 1 | «Selection» | 3 | «Color Information» |
| 2 | «Edit» | 4 | «Embroidery» |

Software Operation







The touch-sensitive display can be operated with the finger or stylus.

Tap: Short tap of an element..





Swipe: Tap an element and swipe quickly on the display.

Draw: Tap the display and slowly move in one direction, eg. for scrolling up and down.



Navigation

Illustration	Name	Purpose
	«Home»	Show Home screen.
	Navigation Path	Show a previous menu level.
	«Close»	Close the window.
	More	Show more features or information.
	Continue	Scroll to next display.
	Back	Scroll to previous display.

Activate/Deactivate Functions

Illustration	Element	Status
	Switch	Function is activated.
		Function is deactivated.
	Icon	Function is deactivated.
		Function is activated.

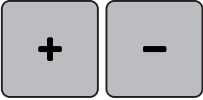





Adjust Values

Illustration	Name	Purpose
	Slider Control	Set the value with the slider control. Reset the value to the default value by tapping the small bullet.
	Field «Plus» / «Minus»	«Plus» increase, «Minus» reduce the value.
	Yellow Frame	Indication that the set value differs from the default value. Reset the value to the default value by tapping.

Enter Text and Numbers

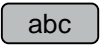
To enter numerical values or text, a corresponding keyboard is shown.

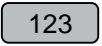
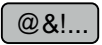

Illustration	Name	Purpose
	Entry Field	Display of the entry. Delete all characters entered with a single tap.
	«Deleting»	Delete the last character.
	«Lower Case Characters»	Show the available letters in lower case letters.
	«Upper Case Characters»	Show the available letters in upper case letters.
	«Numbers and Mathematical Characters»	Show the available numbers and mathematical characters.
	«Special Characters»	Show the available special characters.
	«Confirm»	Confirm the entry and leave the submenu.
	«Cancel»	Cancel the entry and the view closes.

1.7 Needle, Thread, Fabric

Needles will wear down over time. Therefore, the needle should be replaced regularly. Only a perfect point results in a good stitching result. In general, the thinner the fabric, the finer the needle. The illustrated needles are either standard or optional accessory, depending on the machine.

- Needle sizes 70, 75: for light-weight fabrics.
- Needle sizes 80, 90: for medium fabrics.
- Needle sizes 100, 110 and 120: for heavy fabrics.

Overview Needles

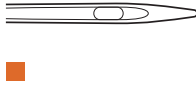
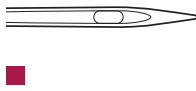
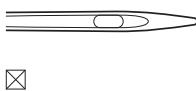
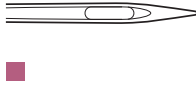
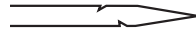
Illustration	Needle Name	Needle Description	Purpose
	Jersey/ Embroidery Needle 130/705 H SUK 80/12	With a medium ball point.	For woven fabrics (light, medium, heavy-weight), knitwear, plastic. For general sewing, sewing on buttons and buttonholes, zippers, hems and topstitching, decorative sewing, embroidery.
	Embroidery Needle 130/705 H-E 75/11 – 90/14	With a light ball point and a particularly wide eye and wide groove.	For woven fabrics (light, medium, heavy-weight), knitwear. For voluminous and woolen threads. For general sewing, sewing on buttons and buttonholes, zippers, hems and topstitching, decorative sewing, embroidery.
	Fine Fabrics Needle 130/705 H SES 70/10 – 90/14	With a light ball point.	For fine, delicate materials, such as velvet. For general sewing, sewing on buttons and buttonholes, zippers, hems and topstitching, decorative sewing, embroidery, patchwork, quilting.
	Metafil Needle 130/705 H METAF IL 80/12	With medium ball point and long eye (2 mm).	For woven fabrics (light, medium, heavy-weight), knitwear. For sewing with special effects and fancy threads, especially metallic threads. For embroidery with metallic thread. For hems and topstitching, decorative sewing and embroidery.
	Felting Needle PUNCH	With small barbs.	For woven fabrics (light, medium, heavy-weight), jeans/denim. For felting a variety of yarns and threads into base fabrics.

Example for Needle Description

The 130/705 system, which is the most common for household machines, is explained by the following picture of a Jersey/Stretch needle.

	<p>130/705 H-S/70</p> <p>130 = Shank length (1)</p> <p>705 = Flat shank (2)</p> <p>H = Needle scarf (3)</p> <p>S = Needle point (here medium ball point) (4)</p> <p>70 = Needle size 0.7 mm (5)</p>
--	---

Needle/Thread Combination

	<p>The needle/thread combination is correct, when the thread fits perfectly into the long groove and goes easily through the needle eye. The thread can be optimally sewn.</p>
	<p>The thread can break and skipped stitches can occur when there is too much clearance in the long groove and the needle eye.</p>
	<p>The thread can break and get stuck when the thread scrapes against the edge of the long groove not fit well into the needle eye optimally.</p>

Upper Thread

A good quality thread (name-brand manufacturer) is essential for embroidery so that the embroidery is not affected negatively because of poor thread or thread breakage.

Embroidery is particularly effective if you use 40wt glossy rayon or polyester embroidery threads as upper threads. They are available in a wide range of colors for beautiful embroidery.

- Polyester with a brilliant sheen is a hard-wearing, colorfast thread and has a high tensile strength which is suitable for all types of embroidery.
- Rayon is a soft viscose fiber with a brilliant sheen and suitable for fine, delicate embroidery, or items that will not receive excessive wear and tear.



- Metallic thread is a light to medium-weight thread suitable for special effects in embroidery.
- When working with metallic threads, the automatic bobbin thread cutter should be deactivated. The other thread cutters shouldn't be used either because the knives are likely to wear off very quickly.
- When using metallic threads, the speed and the upper thread tension should be reduced.



Bobbin Thread

In most cases black or white bobbin thread is used for embroidering. When both sides should have the same look, it is recommended to use the same color for bobbin and upper thread.

- Bobbin Fill is an especially soft and light polyester thread which is suited to be used as bobbin thread. This special bobbin thread ensures a steady thread tension and an optimal intertwining of the upper and bobbin thread.
- Darning and embroidery threads are fine mercerized cotton threads which are suitable for embroidery on cotton.



1.8 Important Embroidery Information

Choosing the Embroidery Design

Simple designs with a low stitch count are suitable for embroidery on fine material. Densely embroidered designs, e. g. embroidered designs with multiple color and embroidery direction changes, are suitable for medium and heavy-weight material.

Selecting the Embroidery File Format

In order that embroidery designs can be read by the BERNINA Embroidery machine, they have to be created by the BERNINA Embroidery Software and exported as .EXP file. Besides the actual embroidery file, a .BMP file and an .INF file are generated additionally. The .BMP file allows a preview of the embroidery design and the .INF file provides the information on the thread colors. **Note:** If the .INF file is missing, the embroidery design cannot be displayed in the real color but only in standard colors. In this case, the colors can be entered manually in the color overview of the motif on the machine.

Additionally, following embroidery formats can be read by the machine: .PES, .PEC, .XXX, .PCS, .JEF and .DST. BERNINA International AG doesn't warrant that embroidery designs which have not been created or converted by the BERNINA Embroidery software can be correctly read and embroidered.

2 Embroidery Preparation

2.1 Before Using the Machine for the First Time



BERNINA recommends lubricating the hook before using the machine for the first time or after a longer period of non-use. (see page 84)

By oiling the hook, the occurrence of unwanted noises in the hook area can be avoided.

2.2 Accessories Box

Accessory box free standing

> On the back of the box, pull both extensions out until they click into place.



Storing accessory

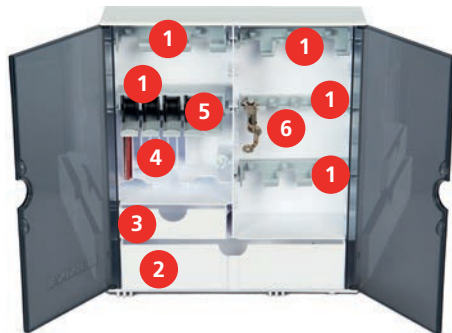

- > Insert the holders (1) for bobbins, feet and needles.
- > Store the small parts, e.g. thread discs etc., in the drawers (2) and (3).
- > Store the provided needle assortment in the special compartment (4).

NOTICE

Scratched Sensor Surfaces of the Bobbin

Malfunction of the lower thread indicator. If the sensor surfaces of the bobbins are scratched or dirty, the bobbin thread indicator will no longer detect the low thread level.

> Always position the bobbins in the bobbin holder with the silver sensor surface to the right.

- > Insert the bobbins into the compartment (5) of the accessories box so that the silvery sensor surfaces are on the right side.
- > To remove a bobbin, press the compartment holder down.
- > Store the embroidery feet (5.5 mm or 9.0 mm) in the holders (6).

Fixing the Touch Screen Pen

- > Store the touchscreen pen at the magnet holder.



Switching the Machine On

- > Set the power switch to «I».



Switching on the sewing light

Prerequisite:

- The sewing light has to be activated in the Setup Program.



- > To switch the sewing light off, push the button «Sewing Light On/Off».
- > To switch the sewing light on, push the button «Sewing Light On/Off» again.
 - The sewing light can also be switched on and off in the Setup Program. (see page 55)

2.4 Foot control (Optional accessory)

Regulating the speed via the foot control

Via the foot control the speed can be adjusted infinitely variable.

- > Press the foot control down carefully to start the machine.
- > To sew faster, press the foot control harder.
- > Release the foot control to stop the machine.



Raising/Lowering the needle

- > Sink the heel back on the foot control to raise/lower the needle.



2.5 Spool Pin

Swiveling Spool Pin

Installing the spool pin



With metallic or other special threads, it is recommend to use the swiveling spool pin.

The swiveling spool pin is used when special threads are embroidered and it can also be used for winding during embroidering.

- > Swivel the spool pin up as far as it will go.



Inserting foam pad and thread spool

The foam pad prevents the thread from getting hooked at the swiveling spool holder.

- > Place the foam pad on the swiveling spool holder.
- > Place the thread spool on the spool holder.



Horizontal Spool Pin

Placing the Foam Pad, the Thread Spool and the Spool Cap

Spool caps hold the thread spool in place for proper release of thread from the spool. The spool cap is only used with the horizontal spool holder.

- > Place the foam pad on the spool pin.
- > Place the thread spool on the spool pin.
- > Position the appropriate spool cap on the spool pin so that there is no space between the spool cap and the thread spool.

Using the Spool Net

The spool net holds the thread on the thread spool and prevents the thread from knotting and breaking. The spool net is only used with the horizontal spool holder.

- > Pull the spool net over the thread spool. Ensure when doing so that the spool net does not slip off the thread spool, e.g. double-insert the net over the thread spools or insert a part of the net into the thread spool at the rear.



Attaching the multiple-spool holder

Additional information how to assemble the multi-spool pin can be found in the separate instruction manual of the multi-spool pin.

2.6 Embroidery foot

Adjusting the Presser Foot Position via the Button «Presser Foot Up/Down»



- > To raise the presser foot, push the button «Presser Foot Up/Down».
- > To lower the presser foot, push the button «Presser Foot Up/Down» again.

Attaching the embroidery foot

- > Raise the needle.
- > Switch the machine off and disconnect it from the power supply system.
- > Push the clamping lever up (1).
- > Guide the embroidery foot upwards over the cone (2).



- > Press the clamping lever down.



Selecting the Stitch Plate in the User Interface

After fitting the corresponding embroidery foot, it can be selected and saved on the machine. Furthermore, any alternative feet that are available for the respectively selected embroidery design are displayed.

- > Switch the machine on.
- > Select the embroidery design.
- > Tap «Presser Foot Indicator/Presser Foot Selection».



- > To display all suitable presser feet for the selected embroidery design, tap «Optional Presser Feet».
- > Select the fitted embroidery foot.

2.7 Needle and Stitch Plate

Inserting the embroidery needle



Embroidery needles of the type 130/705 H-SUK provide a larger eye and are slightly rounded. This avoids thread abrasion when using Rayon- and cotton embroidery thread. Depending on the embroidery thread use a size No. 70-SUK to No. 90-SUK needle.

- > Raise the needle.
- > Switch off the machine.
- > Remove the fitted foot.
- > Loosen the fixing screw of the needle using the screwdriver gray Torx.



- > Pull the needle down.
- > Hold the new needle with the flat side to the back.
- > Insert the needle as far as it will go.
- > Tighten the needle clamp using the gray Torx screwdriver.

Selecting the needle in the User Interface

After changing the needle, you can check whether this can be used with the selected stitch plate.



- > Tap «Needle Selection».
- > Select the fitted needle.



- If the selected needle is suitable in combination with the stitch plate, embroidering can be started.
- If the selected needle is not suitable in combination with the stitch plate, starting the machine is automatically blocked.

Selecting needle type and needle size

Convenient memory function: To prevent a loss of information, the needle type and the needle size can be saved additionally on the machine. The saved needle type and the saved needle size can be checked at any time.



- > Tap «Needle Selection».



- > Tap «Needle Information».



- > Select the needle type (1) of the fitted needle.
- > Select the needle type (2) of the fitted needle.

Attaching the stitch plate

The stitch plate has a small hole in the needle insertion area. The thread is pulled in and knotted optimally which results in an optimized stitching result.

Prerequisite:

- The machine is switched off and disconnected from the power supply system.
 - The foot and the needle are removed.
- > Press the stitch plate down at the mark back right until it flips up.



- > Remove the stitch plate.
- > Place the openings of the stitch plate (PunchWork, Optional accessory) above the corresponding guide pins and press down until it clicks into place.



Selecting the stitch plate in the User Interface

After changing the stitch plate, you can check whether it can be used with the selected needle.



- > Tap «Stitch Plate Selection».
- > Select the fitted stitch plate (PunchWork, optional accessory).



- If the selected needle is suitable in combination with the stitch plate, embroidering can be started.
- If the selected needle is not suitable in combination with the stitch plate, starting the machine is automatically blocked.

2.8 Threading

Threading the upper thread

Prerequisite:

- The needle and the presser foot are raised.
 - The machine is switched off.
- > Place the foam pad on the spool pin.
- > Place the thread spool on the spool pin so that the thread unwinds clockwise.

- > Attach the appropriate spool cap.
- > Guide the thread in direction of the arrow through the rear thread guide (1) and hold the thread with the hands so that it is taut and can be inserted into the thread tension.
- > Guide the thread in direction of the arrow through the thread tension (2).



- > Guide the thread downwards (3) around the thread take-up lever cover (4).
- > Guide the thread upwards and insert into the thread take-up lever (5).
- > Guide the thread downwards again (6).



- > Guide the thread through the guides (7/8) above the presser foot.



- > Switch the machine on.



- > Press the semi-automatic threader lever (9) slightly down, keep it pressed and pull the thread to the left beneath the gray threader finger/hook (10).



- > Guide the thread around the gray threader hook from the left to the right (12).
- > Press the threader lever down as far as it will go (11) and then pull the thread from the left to the right (12) through the threader slot (13) until it hooks into the small wire hook.

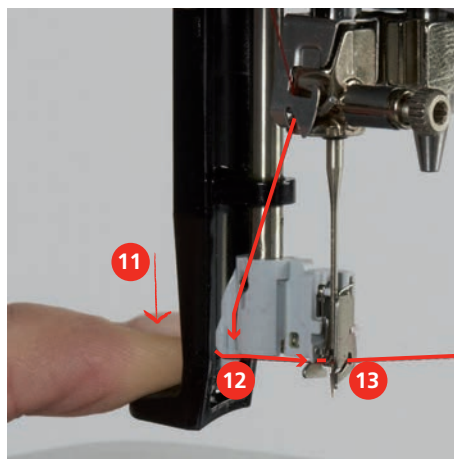

- > Release the lever and the thread simultaneously to thread.
- > Pull the thread loop (14) to the back.

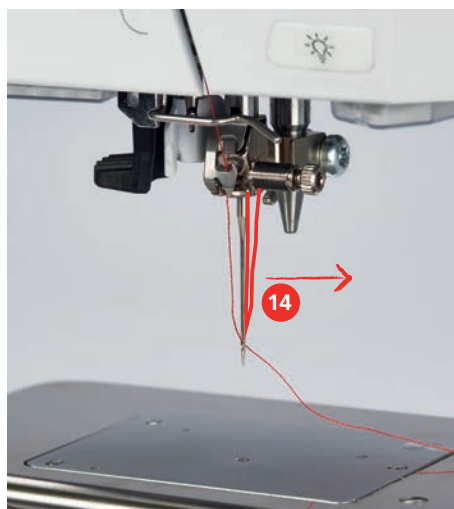

- > Pull the thread beneath the presser foot from back to front over the thread cutter (15) and cut.



Winding the bobbin thread



The bobbin thread can be wound while embroidering if the swiveling spool holder is used for winding.

Prerequisite:

- The foam pad, the thread spool and the appropriate spool disc are fitted.
- > Place the empty bobbin on the Winding Unit (1) so that the silvery sensor surface is down.



- > Guide the thread to the left into the rear thread guide (2).
- > Guide the thread around the bobbin winder pretension clockwise (3).
- > Wind the thread clockwise 2 – 3 times around the empty bobbin (4).

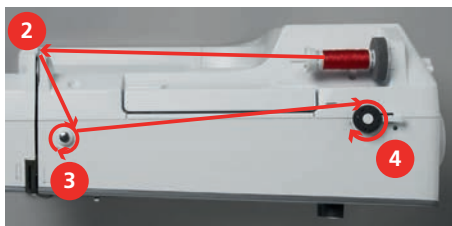

- > Pull the excess thread over the thread cutter at the engaging lever (5) and cut.

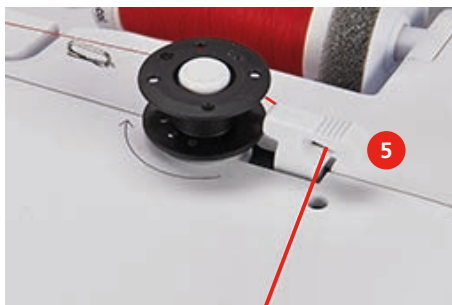

- > Push the engaging lever (6) towards the bobbin.

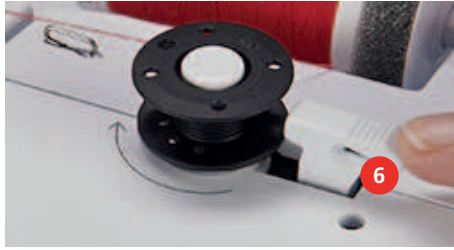

- The machine winds and the display to wind the bobbin appears.
- > Set winding speed.
- > To stop the winding process, the engaging lever must be pushed to the right.
- > Push the engaging lever towards the bobbin again to continue the winding process.
 - As soon as the bobbin is full, the machine stops the winding process automatically.
- > Remove the bobbin and cut the thread using the thread cutter at the engaging lever.

Threading the Bobbin Thread

Prerequisite:

- The needle is raised.
- The machine is switched off and the bobbin cover is opened.
- > Press the bobbin case release at the bobbin case (1).

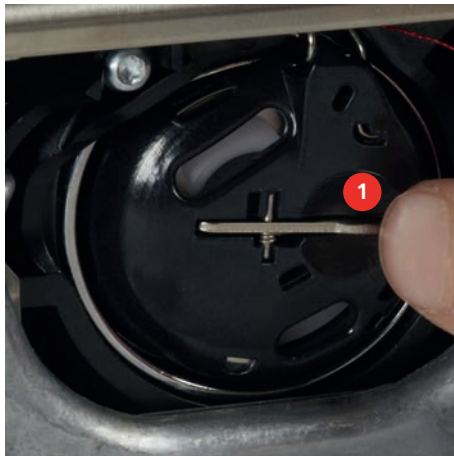

- > Remove the bobbin case.
- > Remove the bobbin from the bobbin case.
- > Insert the new bobbin so that the silvery sensor surface is facing the back of the bobbin case.



- > Pull the thread into the slot (2) from the left.



- > Pull the thread to the right under the spring (3), then pass it below the two thread guides (4) and pull it upwards.



- > To insert the bobbin case into the machine, hold it so that the thread guide (5) points upwards.



- > Insert the bobbin case.
- > Press onto the center of the bobbin case until it engages.



- > Pull the thread through the thread cutter (6) and cut.

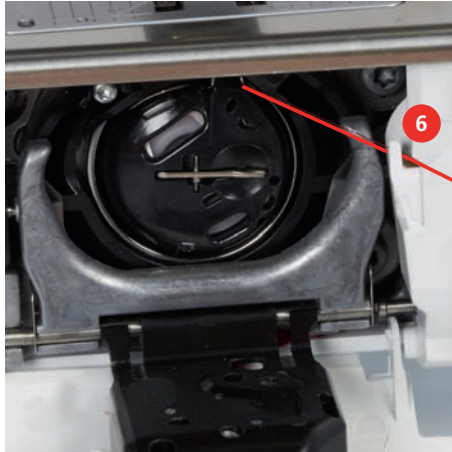

- > Close the looper cover.

Thread-up Command

The machine must be ready for embroidery to bring up the bobbin thread. The bobbin thread can be brought up in one step for a manual knotting. If no securing stitches are wanted, it is recommended to deactivate the securing stitches in the Setup.



- > Hold the upper thread.
- > Push the button «Presser Foot Up/Down».
 - The bobbin thread is brought up automatically.

Indicating Fill Level of Bobbin Thread

When the fill level of the bobbin thread is low, an animation appears in the icon «Bobbin Thread» to indicate that the bobbin thread is about to run out.



- > To thread the bobbin thread according to the animation, tap, «Bobbin Thread».

2.9 Attaching the Module

NOTICE

Transporting the Embroidery Module

Damage to the embroidery module connection and machine.

- > Remove the embroidery module before transporting the machine.

Prerequisite:

- Extension table must not be fitted.
- > Make sure that the module and the machine are placed on a stable, even surface.
- > Ensure that the embroidery arm can move freely.
- > Lift the embroidery module on the left side.
- > Carefully push the module from left to right into the embroidery module connection (1) of the machine.

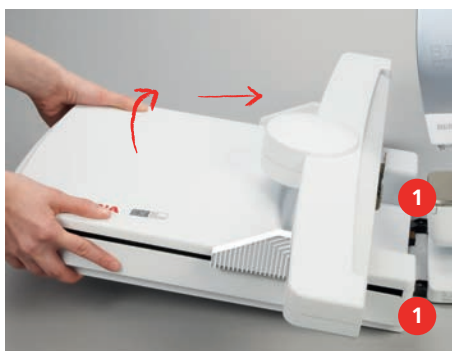

> To remove, lift the embroidery module on the left and carefully pull to the left.

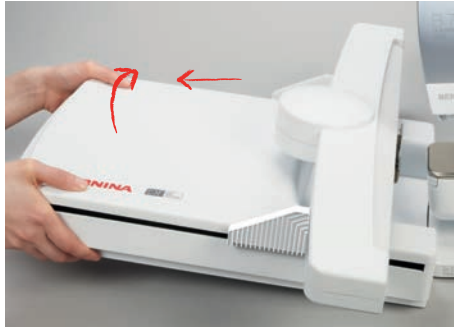

2.10 Selecting the embroidery motif

All of the embroidery designs can be either directly embroidered or can be changed using different functions offered by the machine. All the embroidery designs can be found at the end of this instruction manual. In addition to that, embroidery designs can be loaded from the personal memory or from the BERNINA USB stick (optional accessory).

Prerequisite:

- The Drop-shaped Embroidery Foot #26 is fitted.
- > Select an alphabet, embroidery design or a personal embroidery design from one of the files.

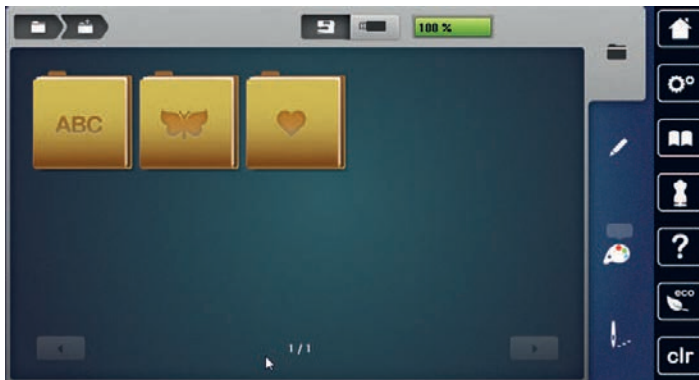

2.11 Embroidery Hoops

Overview Embroidery Hoop Selection

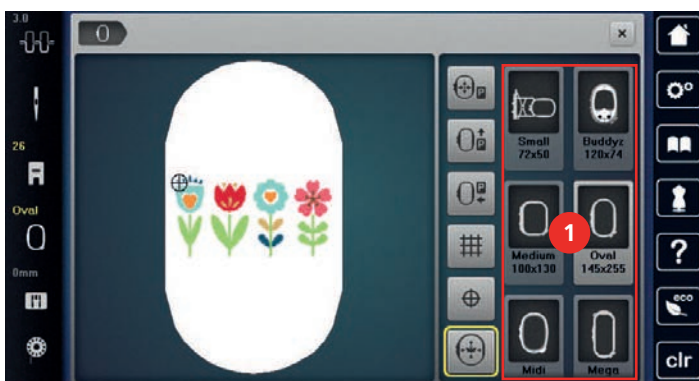

1 Hoop Selection

Selecting the Embroidery Hoop

The best embroidery result is achieved when the smallest possible embroidery hoop for the embroidery design is selected.

The embroidery design has a pre-set size which is displayed.

Prerequisite:

- The embroidery design is selected.



- > Tap «Hoop Indicator/Select Hoop».
 - The machine selects the optimal embroidery hoop according to the size of the embroidery design automatically. If the preset embroidery hoop is not available, another desired embroidery hoop can be selected. When an embroidery hoop is attached which does not correspond with the selected one, the attached hoop is considered active and the embroidery design area is displayed accordingly.
- > Select the desired embroidery hoop.

Tear-away Stabilizers

Using a stabilizer ensure more stability of the embroidery project. A tear-away stabilizer suits all woven and non-stretch materials. 1 – 2 layers can be used. Stabilizers are available in different weights. With larger areas to be embroidered the stabilizer will remain under the embroidery thread. The stabilizer is applied to the wrong side of the fabric with temporary adhesive spray. Carefully cut away excess stabilizer after embroidering.

Cut-away Stabilizers

Using a stabilizer ensure more stability of the embroidery project. A cut-away stabilizer suits all elastic materials. 1 – 2 layers can be used. Stabilizers are available in different weights. With larger areas to be embroidered the stabilizer will remain under the embroidery thread. The stabilizer is applied to the wrong side of the fabric with temporary adhesive spray. Carefully cut away excess stabilizer after embroidering.

Using Adhesive Spray

The application of spray adhesive is recommended for stretch and smooth materials and knitware. It prevents the fabric from losing shape and slipping. Appliqués can be exactly positioned with spray adhesive. The spray adhesive shouldn't be used near the machine to avoid contamination.

- > Use the spray adhesive carefully at a distance 25 – 30 cm (9 – 12 inch) when spraying the stabilizer.
- > Adhere the sprayed stabilizer to the wrong side of the fabric carefully, smoothing material so there are no puckers.
- > Position smaller parts such as pocket flaps or collars on the stabilizer.
- > To avoid the possibility of getting hoop marks when working with napped materials or fleece, don't hoop the parts but spray the stabilizer and hoop it.
- > Adhere the fabric to be embroidered.
- > Remove any adhesive residue before starting the machine.

Using Spray Starch

Spray starch is ideal for additional stiffening fine, loosely woven materials. Always use an additional stabilizer on the wrong side of the material.

- > Spray the area to be embroidered.
- > Let it dry or press gently with a warm iron if necessary.

Using Iron-on Interfacing

Iron-on interfacings are available in a variety of weights. It is recommended to use an iron-on interfacing which is easily removable from the basic fabric. An Iron-on interfacing suits all materials that are easily distorted like stretch fabric such as tricot and jersey.

- > Iron-on interfacings are ironed to the wrong side of the material using a warm iron.



Using Paper-backed Adhesive Stabilizer

Paper-backed adhesive stabilizers are intended to be used for fabrics such as jersey and silk as well as for embroidery projects which are not suited to be hooped in the embroidery hoop.

- > Place the stabilizer in the hoop, so that the paper side is up.
- > Use a pair of scissors to score the paper and remove paper in the hoop area.
- > Position the fabric to be embroidered on the stabilizer and press it on place.
- > Remove any adhesive residue before starting the machine.

Using Water-soluble Stabilizer



For lace embroidery it is recommended to hoop 1 - 3 layers of water-soluble stabilizer in the embroidery hoop. As the embroidery design is not embroidered on the fabric, only the thread embroidered design is left. The embroidery designs should be combined with short stitches otherwise the individual designs may fall out.

Water-soluble stabilizers are ideal for fine, sheer fabrics where other stabilizers may show through the embroidery stitches as well as for lace embroidery. The stabilizer dissolves in water. Water-soluble stabilizers are an ideal protection for looped pile fabrics preventing the loops from being damaged. It prevents threads from sinking into the material and keeps the fabric pile from poking through the embroidery.

- > Place the stabilizer on the underside of the material.
- > Use adhesive spray to adhere stabilizer if necessary.
- > For material with a pile, reinforce with additional, suitable stabilizer on the wrong side.
- > Place all the layers together into the embroidery hoop.
- > After dissolving, lay the motif down flat and let dry.

Preparing the Embroidery Hoop

The embroidery hoop consists of an outer and an inner hoop. There is a corresponding template for every hoop. The area to be embroidered is marked in 1 cm (0.39 inch) squares. The center and corner points are marked with holes. The required marks can be transferred to the material.

- > Mark the center of an embroidery design on the fabric, using a water-soluble pen.

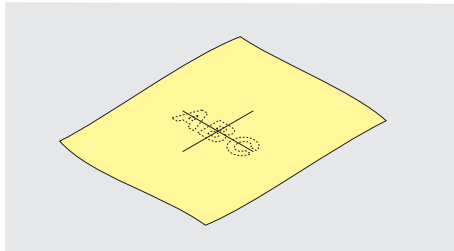

- > Loosen the screw on the outer hoop.
- > Remove the inner hoop.
- > Make sure that the arrows marks of both hoops match.
- > Attach the template holder.
- > Place the template in the inner hoop, so the BERNINA logo is at the front edge at the arrow mark until it clicks into place.

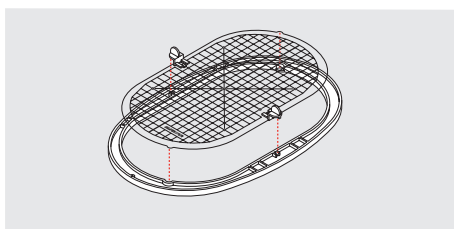

- > Place the fabric under the inner hoop.
- > Line up the marked center point on the center of the template.

- > Place the material and the inner hoop on the outer hoop, so that the arrow markings of both hoops are aligned.

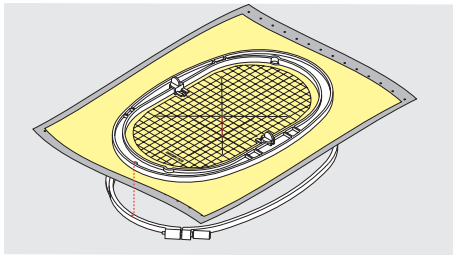

- > Fit the hoops into each other so that the material does not move.
- > Hoop the fabric tautly in the embroidery hoop.
- > Tighten the screw.
- > Remove the template from the hoop by using the template holder.
- > To avoid scratches on the free arm, press the inner hoop into the outer hoop so that the inner hoop including the fabric protrudes downwards by up to 1 mm.

Attaching the Hoop

- > Raise the needle.
- > Raise the embroidery foot.
- > Hold the hoop with the right side of the fabric up with the attaching mechanism to the left.
- > Position the hoop below the embroidery foot.
- > Press both attaching mechanisms (1) of the hoop towards each other.
- > Position the embroidery hoop (2) above the bracket of the embroidery arm.
- > Press the hoop down until it clicks in position.
- > Release the attaching mechanism (1).

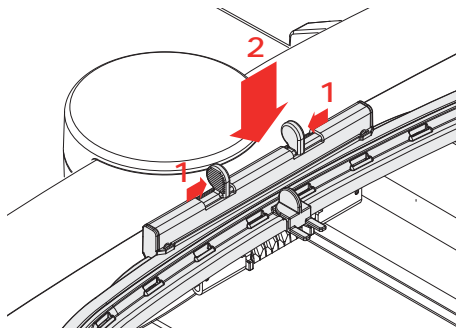

- > Press the attaching mechanisms of the hoop towards each other to remove the hoop.
- > Remove the hoop.



Overview embroidery functions



- | | | | |
|---|---|---|-------------------------------|
| 1 | «Centering the Needle to the Embroidery Hoop» | 4 | «Grid On/Off» |
| 2 | «Move Hoop to the Back» | 5 | «Center of Embroidery Design» |
| 3 | «Move Hoop to the Left» | 6 | «Virtual Positioning» |



Centering the embroidery hoop to the needle

Relocating the embroidery hoop facilitates threading when the needle is close to the embroidery hoop.



-  > Tap «Hoop Indicator/Select Hoop».
-  > Tap «Centering the Needle to the Embroidery Hoop».
- > Thread the upper thread.
-  > To move the hoop back to its previous position, push the button «Start/Stop».

Moving the hoop to the back

To facilitate changing the bobbin, it is recommended to move the hoop to the back before threading. This makes it easier to open the bobbin cover.

-  > Tap «Hoop Indicator/Select Hoop».
-  > Tap «Move Hoop to the Back».
- > Thread the bobbin thread. (see page 41)
-  > To move the hoop back to its previous position, push the button «Start/Stop». If available, pull the upper thread back.

Moving the embroidery arm to the left

-  > Tap «Hoop Indicator/Select Hoop».
- > Remove the embroidery hoop.
-  > Tap «Move Hoop to the Left».
- An animation «Remove the Embroidery Hoop» appears.
-  > Tap «Confirm».
- The embroidery arm moves to the left into the parking position.

Grid On/Off

When the center of the hoop and the grid are displayed, the embroidery design can be positioned more exactly.



> Tap «Hoop Indicator/Select Hoop».



> To show the hoop center on the display, tap «Grid On/Off».

> To show the grid lines, tap «Grid On/Off» again.

> To hide the hoop center and the grid lines, tap «Grid On/Off» again.

Locating the center of the embroidery motif

The embroidery hoop is positioned so that the needle is exactly above the center of the embroidery design or the motif begin.



> Tap «Hoop Indicator/Select Hoop».



> To position the hoop so that the needle is placed exactly over the center of the embroidery design, tap «Center of Embroidery Design».

> To position the hoop so that the needle is placed exactly over the motif start, tap «Center of Embroidery Design» again.

Virtual Positioning of the Embroidery Hoop

The embroidery hoop is automatically moved to the new position as soon as the embroidery design is repositioned. Therefore, the icon «Virtual Positioning» is activated automatically and outlined in yellow when an embroidery hoop is attached.

Prerequisite:

- The hoop is attached.



> Tap «Hoop Indicator/Select Hoop».



> To deactivate the automatic movement of the hoop after repositioning the embroidery design, tap «Virtual Positioning».

- The «Virtual Positioning» is not yellow-outlined.

> To activate the automatic movement of the hoop after repositioning the embroidery design, tap «Virtual Positioning» again.

3 Setup Program

3.1 Embroidery Settings

Adjusting the Upper Thread Tension

Changes to the upper thread tension in the Setup Program affect all of the embroidery designs.



> Tap «Setup Program».



> Tap «Embroidery Settings».



> Tap «Adjusting the Upper Thread Tension».
> Adjust the upper thread tension.

Adjusting the Maximum Embroidering Speed

The maximum speed can be reduced by this function.



> Tap «Setup Program».



> Tap «Embroidery Settings».



> Tap «Maximum Embroidering Speed».
> Set the maximum sewing speed.

Centering or opening embroidery motifs in the original position

When opening the embroidery motifs on the machine, they are always centered in the Embroidery Hoop. If it is desired to open embroidery motifs in the original position (determined by the BERNINA Embroidery Software), the function «Centering the Embroidery Design» must be activated.



> Tap «Setup Program».



> Tap «Embroidery Settings».



> Tap «Centering the Embroidery Design».



> Tap the Switch.
– A previously moved embroidery motif which has been saved in the new position is opened in the saved position after selecting.



> Tap the Switch again.
– The embroidery motif is centered to the Embroidery Hoop.

Calibrating the embroidery hoop



The calibration of the embroidery hoop is the coordination of the needle to the center of the embroidery hoop.

Prerequisite:

- The embroidery module is connected and the embroidery hoop with the appropriate embroidery template is attached.





> Tap «Setup Program».

-  > Tap «Embroidery Settings».
-  > Tap «Calibrating the Embroidery Hoop».
-  > To delete the current calibration, tap «Deleting» (1).
- > Center the needle via the arrow icons on the display.







Entering the fabric thickness

If the fabric thickness is more than 4 mm as for e.g. toweling, it is recommended to select 7.5 mm or 10 mm. The thicker the fabric, the slower the embroidery speed of the machine. When the machine is switched off, the alterations are reset to the basic setting 4 mm.

-  > Tap «Setup Program».
-  > Tap «Embroidery Settings».
-  > Tap «Entering the Fabric Thickness».
- > Select fabric thickness.

Activating/Deactivating the function thread away

To bring up the thread end after cutting and to pull it out of the fabric, the function must be activated. For embroidery motifs with long stitches it is recommended to deactivate the function Thread Away. If the distance between the presser foot and the embroidery hoop is too small, the function will not be carried out.

-  > Tap «Setup Program».
-  > Tap «Embroidery Settings».
-  > Tap «Thread Away».
-  > Activating/Deactivating the function thread away.







Programming the securing stitches

Embroidery motifs are programmed either with or without securing stitches. If an embroidery motif has programmed securing stitches, they will be embroidered. If the embroidery motif is programmed with securing stitches, the securing stitches can be removed in the BERNINA Embroidery Software.

The machine recognizes when no securing stitches are programmed and adds them. If no securing stitches are wanted, they can be deactivated.

-  > Tap «Setup Program».

Setup Program



-  > Tap «Embroidery Settings».
-  > Tap «Securing Stitches».
-  > To deactivate the securing stitches at the start, switch off the switch in the upper section.
 - If the embroidery motif doesn't have any programmed securing stitches, none are embroidered.
-  > Turn on the switch in the upper section to deactivate the securing stitches at the start.
 - If the embroidery motif doesn't have any programmed securing stitches, the securing stitches are added and will be embroidered.
-  > Turn off the switch in the lower section to deactivate the securing stitches at the end.
 - If the embroidery motif doesn't have any programmed securing stitches, none are embroidered.
-  > Turn on the switch in the lower section to activate the securing stitches at the end.
 - If the embroidery motif doesn't have any programmed securing stitches, the securing stitches are added and will be embroidered.

Adjusting the thread cut

The settings for the thread cut can be customized. Deactivate the thread cut before a color change (1) or adjust the length of the connecting stitch (3). The machine does the cutting of the connecting threads at the determined length for you. First, set the length from which the connecting stitches are cut, and then select the embroidery design.



The length of the connecting thread can be adjusted between 1 mm and 15 mm, the default setting is 6 mm. This means that all connecting stitches longer than 6 mm are cut automatically. If the value is reduced to 1 mm, more thread cuts are carried out, it takes longer to embroider and more loose thread ends can be seen on the wrong side of the fabric, especially when the function 'Thread-away' is activated too. On the right side of the fabric there will be practically none or merely very short connecting stitches which results in a wonderful stitch formation. Reducing the length of the thread cut to 1 mm is particularly of advantage when embroidering texts where usually many short connecting threads occur. When both sides of the embroidery designs are visible, it may be reasonable to not reduce the length of the thread cut so much so that there won't be too many loose thread ends on the wrong side of the fabric. Loose ends get sewn over and can hardly be removed afterwards.

-  > Tap «Setup Program».
-  > Tap «Embroidery Settings».
-  > Tap «Thread Cut Settings».



-  > To deactivate the automatic thread cut before changing a thread, tap the switch in the upper section of the display (1).
- > To activate the automatic thread cut before changing a thread, tap the switch in the upper section of the display (1) again.

- > Tap the switch in the middle section of the display (2) so that the machine will stop after about 7 stitches and the remaining thread can be cut manually.
- > Tap the switch in the middle section of the display (2) again and the machine won't stop for a manual thread cut.
- > To adjust the length from where the connecting stitches are cut, tap «Minus» or «Plus» (3).

Changing the measuring unit

The measuring unit in the Embroidery Mode can be changed from mm to inch. The standard setting is in mm.



- > Tap «Setup Program».



- > Tap «Embroidery Settings».



- > Tap «Measuring Unit».
- > To display the measurements in the Embroidery Mode in inch, tap «inch».
- > To display the measurements in the Embroidery Mode in mm, tap «mm».

3.2 Selecting personal settings



- > Tap «Setup Program».



- > Tap «Personal Settings».
- > Select the required display color and background.
- > Tap the text box above the color settings.
- > Enter and confirm the welcome text.

3.3 Monitoring Functions

Activating the Upper Thread Indicator



- > Tap «Setup Program».



- > Tap «Monitoring Functions».



- > Tap the switch in the upper section of the display to deactivate the upper thread indicator.
- > Tap the switch again to activate the upper thread indicator.

Activating the Bobbin Thread Indicator



- > Tap «Setup Program».



- > Tap «Monitoring Functions».



- > Tap the switch in the lower section of the display to deactivate the bobbin thread indicator.
- > Tap the switch again to activate the bobbin thread indicator.

3.4 Activating the audio signals

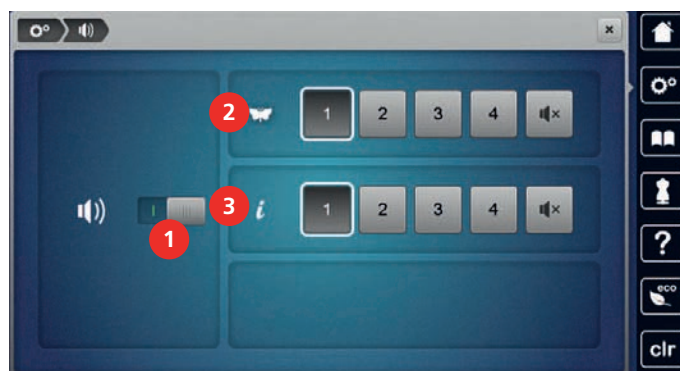

> Tap «Setup Program».



> Tap «Setting Sound».



> To switch off the sound when selecting an embroidery design, tap the corresponding area (2) «Switching Sounds On/Off».



> To switch on the sound when selecting an embroidery design, tap the corresponding area (2) «1 – 4».

> To switch off the sound for selecting functions, tap the corresponding «Switching Sounds On/Off» in area (3).

> To switch on the sound for selecting functions, tap the corresponding in area (3) «1 – 4».

3.5 Machine Settings

Selecting a language

The User Interface can be programmed in different languages according to the customer's wish because BERNINA provides a wide range of international languages for the customers. Via firmware updates additional languages for the User Interface can be provided.



> Tap «Setup Program».



> Tap «Machine Settings».



> Tap «Language Selection».

> Select a language.

Adjusting the Brightness of the Display

The brightness of the display can be set to meet your individual needs.



> Tap «Setup Program».



> Tap «Machine Settings».



> Tap «Display Settings».

> Adjust the brightness of the display in the upper section of the screen.

Deleting motifs on the BERNINA USB Stick

- > Insert the BERNINA USB stick into the USB Port of the machine.
- > Tap «Setup Program».



- > Tap «Machine Settings».



- > Tap «Factory Setting».



- > Tap «Deleting USB Stick» and confirm.



Packing the embroidery module

To pack the embroidery module into the original packaging without moving the embroidery arm manually, the embroidery arm needs to be brought to its packing position.

Prerequisite:

- The embroidery module is connected with the machine.

- > Tap «Setup Program».



- > Tap «Machine Settings».



- > Tap «Maintenance/Update».



- > Tap «Packing Position».
- > Follow the instructions on the display.



Reviewing the total number of stitches

The total number of stitches by the machine and the number of stitches since the last maintenance carried out by a specialist BERNINA dealer are displayed.

- > Tap «Setup Program».



- > Tap «Machine Settings».



- > Tap «Information».



- > Tap «Machine Data».



Registering details of the dealer

The contact details for your specialized BERNINA dealer can be entered.

- > Tap «Setup Program».



- > Tap «Machine Settings».



- > Tap «Information».



4 System Settings

4.1 Calling up the tutorial

The Tutorial gives information and explanations concerning various aspects of embroidering.



- > Tap «Tutorial».
- > Select the desired topic in order to view information.

4.2 Calling up the Embroidery Consultant

The Embroidery Consultant informs you about decision support for embroidery projects. After entering the desired embroidery project and the fabric, suggestions for the suitable needle and the suitable embroidery foot are displayed.



- > Tap «Embroidery Consultant».
- > Select the embroidering project.
- > Select the fabric on which you want to embroider.



- > Tap «Confirm».
- If an embroidery motif has already been selected, a warning appears stating that this will be overwritten.

4.3 Calling Up the Help

- > Touch the window in the display where help is needed.
- > To start the Help Mode, tap «Help» twice.
- > Tap the icon in the display where help is needed.



4.4 Using eco mode

During a longer interruption of work the machine can be set into a power save mode. The power save mode also serves as a child safety feature. Nothing can be selected in the display and the machine cannot be started.



- > To activate the power save mode, tap «eco Mode».
- The display goes to sleep. The power consumption is reduced and the sewing light is off.
- > To deactivate the power save mode, tap «eco Mode» again.

4.5 Cancelling Any Alterations with «clr»

Any alterations to designs can be reset to basic setting. Exceptions are saved designs which have been filed in the personal memory and monitoring functions.



- > Tap «Clear Settings».

5 Creative Embroidering

5.1 Overview Embroidering

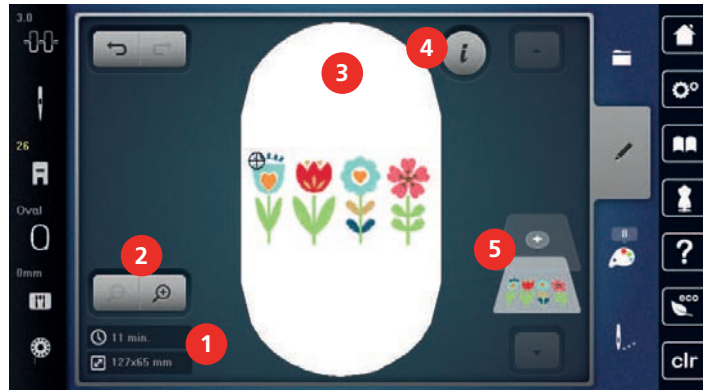

- | | | | |
|---|--|---|--------------------------|
| 1 | Embroidery Time/Embroidery Design Size | 4 | «i-Dialog» |
| 2 | Scaling Up, Downsizing and Moving the Embroidery Design View | 5 | Embroidery design Layers |
| 3 | Area to be Embroidered | | |

5.2 Selecting and Changing the Embroidery Design



- > Tap «Selection».



- > Tap «Loading the Embroidery Design».
- > Select a new embroidery design.

5.3 Checking the Embroidery Time and the Embroidery Design Size

In the selection menu «Edit» the estimated embroidery time in minutes as well as the width and height of the embroidery design is indicated at lower left (1).

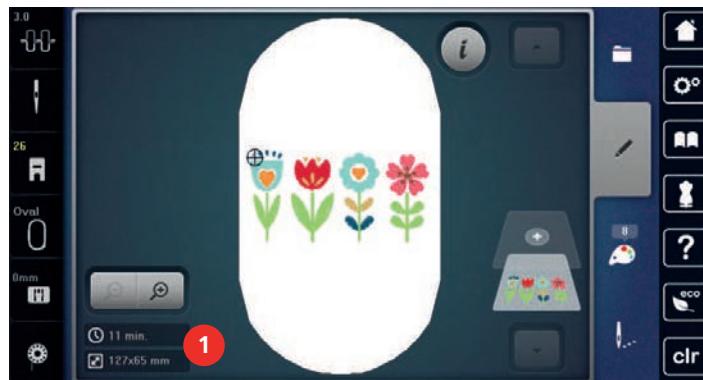

5.4 Regulating the Speed

The sewing speed can be adjusted infinitely variable with the slide.

- > Move the slide to the left to reduce the sewing speed.
- > Move the slide to the right to increase the sewing speed.



5.5 Editing the Embroidery Design

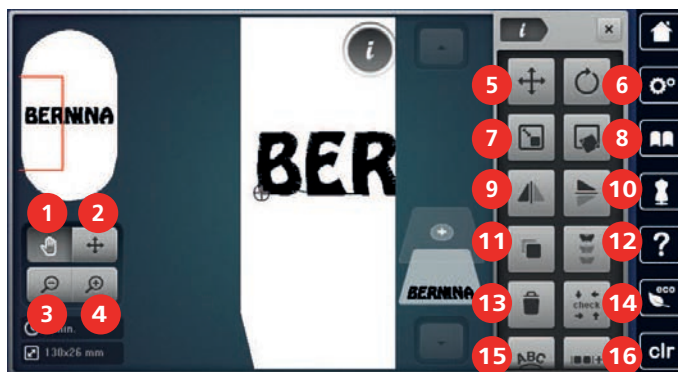

Overview Editing embroidery motif



- | | | | |
|---|----------------------------------|----|--|
| 1 | «Move View» | 10 | «Mirror Image Up/Down» |
| 2 | «Moving the Embroidery Design» | 11 | «Duplicating» |
| 3 | «Zoom Out» | 12 | «Endless Embroidery» |
| 4 | «Zoom In» | 13 | «Deleting an Embroidery Design» |
| 5 | «Moving the Embroidery Design» | 14 | «Check Embroidery Design Size» |
| 6 | «Rotating the Embroidery Design» | 15 | «WordArt»
(activated after text entry) |
| 7 | «Change Design Size» | 16 | «Group Embroidery Motifs» |
| 8 | «Pinpoint Placement» | 17 | «Change Embroidery Motif Sequence»
(becomes visible by scrolling) |
| 9 | «Mirror Image Left/Right» | 18 | «Alter Stitch Type/Stitch Density»
(becomes visible by scrolling) |



Scaling Up the Embroidery Design View

The view of the embroidery design can be scaled up. In addition to that, the view can be adjusted with or without changing the embroidery position.

- > Select the embroidery design.
-  > To edit the view of the embroidery design, tap «Zoom In».
-  > To scale up the view of the embroidery design, tap «Zoom In» 1 up to 4 times.
-  > To get back to the Edit Mode, tap «Zoom Out» 1 up to 4 times.

Downsizing the Embroidery Design

The view of the embroidery design can be downsized. In addition to that, the view can be adjusted with or without changing the embroidery position.

- > Select the embroidery design.
-  > To edit the view of the embroidery design, tap «Zoom In».
-  > To downsize the view of the enlarged embroidery design gradually, tap «Zoom Out» 1 – 4 times.

Moving the Embroidery Design View

The view of the embroidery design can be moved. In addition to that, the view can be adjusted with or without changing the embroidery position.

- > Select the embroidery design.
-  > To activate «Move View», tap «Zoom In».
 - «Move View» is activated (dark gray).

- > Move the view of the embroidery design.
 - The embroidery position is not altered.

-  > To get back to the Edit Mode, tap «Zoom Out».

Moving the Embroidery Design in Enlarged View

In addition to that, the view can be adjusted with or without changing the embroidery position. In addition to that, the view can be adjusted with or without changing the embroidery position.

- > Select the embroidery design.
-  > To display the icon «Relocating a Stitch Pattern», tap «Zoom In».

-  > Tap «Moving the Embroidery Design».
 - The icon turns dark gray.

- > Move the view of the embroidery design.
 - The embroidery position is altered.

-  > To get back to the Edit Mode, tap «Zoom Out».

Moving the Embroidery Design

- > Select an embroidery motif.
-  > Tap «i-Dialog».

-  > Tap «Moving the Embroidery Design».
 - > Turn the «Upper Multi-function knob» to move the embroidery motif horizontally in 1/10-mm steps.
 - > Turn the «Lower Multi-function knob» to move the embroidery motif vertically in 1/10 mm steps or tap and hold the embroidery motif to move the embroidery motif as you like.
 - The relocation is indicated in the yellow-outlined icons.

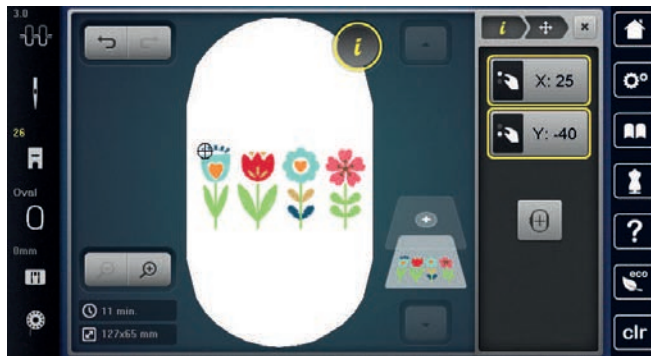

-  > Tap «Centering the Embroidery Design».
 - The embroidery motif is repositioned in the center of the embroidery hoop.

Rotating the Embroidery Design

- > Select the embroidery design.
-  > Tap «i-Dialog».

-  > Tap «Rotating the Embroidery Design».
 - > Turn the «Upper Multi-function Knob» or the «Lower Multi-function Knob» to the right to rotate the embroidery design clockwise.
 - > Turn the «Upper Multi-function Knob» or the «Lower Multi-function Knob» to the left to rotate the embroidery design counter-clockwise.

-  > To rotate the embroidery design in 90°-steps, tap «Rotate the Embroidery Design +90°».

Altering the Embroidery Design Size Proportionally



Enlargements or reductions of the motif size up to maximum 20 % achieve the best results.
If the motif size is to be altered by more than 20 %, the motif should be adapted in a separate embroidery software and then reloaded onto the machine.



- > Select the embroidery design.
- > Tap «i-Dialog».



- > Tap «Change Design Size».



- > If «Retain Proportions» is not outlined in white, tap «Retain Proportions».
 - «Retain Proportions» is outlined in white.



- > Turn the «Upper/Lower Multi-function Knob» to the right to scale up the embroidery design proportionally.
- > Turn the «Upper/Lower Multi-function Knob» to the left to downsize the embroidery design proportionally.

Altering the Embroidery Design Size Disproportionally



Enlargements or reductions of the motif size up to maximum 20 % achieve the best results.
If the motif size is to be altered by more than 20 %, the motif should be adapted in a separate embroidery software and then reloaded onto the machine.



- > Select the embroidery design.
- > Tap «i-Dialog».



- > Tap «Change Design Size».



- > If «Retain Proportions» is outlined in white, tap «Retain Proportions».
 - «Retain Proportions» is not outlined in white.



- > To make the embroidery design wider, turn the «Upper Multi-function Knob» clockwise.
- > To make the embroidery design narrower, turn the «Upper Multi-function Knob» anti-clockwise.
- > To make the embroidery design longer, turn the «Lower Multi-function Knob» clockwise.
- > To make the embroidery design shorter, turn the «Lower Multi-function Knob» anti-clockwise.

Mirroring Embroidery Designs

Embroidery designs can be mirror-imaged both vertically and horizontally.

- > Select the embroidery design.
- > Tap «i-Dialog».



- > To mirror the embroidery design horizontally, tap «Mirror Image Left/Right».



- > To mirror the embroidery design vertically, tap «Mirror Image Up/Down».

Changing the Stitch Type

If the satin stitches are too long, they can be changed to step stitches.

- > Select the Embroidery Design.
- > Tap «i-Dialog».



- > Tap «Alter Stitch Type/Stitch Density».



- > Touch the switch in the upper section of the display (1) to change the satin stitch to the step stitch.
- > Set and confirm the stitch length 2.

Altering the Stitch Density

If the satin stitches are embroidered too densely, the stitch density can be adjusted.

- > Select the embroidery design.
- > Tap «i-Dialog».



- > Tap «Alter Stitch Type/Stitch Density».



- > Adjust the stitch density (1).

Checking the embroidery motif size and position

It can be checked whether or not the embroidery design matches the designated position/location on the fabric. Points which are beyond the embroidery hoop are not traveled to.

> Select the embroidery design.

> Tap «i-Dialog».



> Tap «Check Embroidery Design Size».

– The embroidery hoop travels all the way until the needle is at the position as it is indicated in the display.

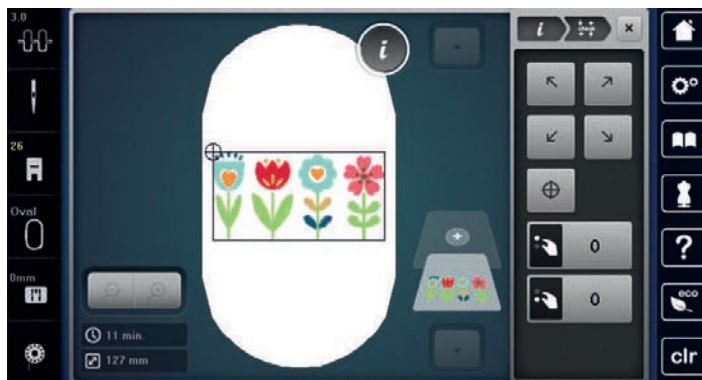

> To select the desired corner of the embroidery design, tap the respective arrow.

– The embroidery hoop travels all the way until the needle is at the position as it is indicated in the display. If the embroidery design hasn't been positioned correctly yet, the position can be altered via the «Upper/Lower Multi-function knobs» and the complete embroidery positions can be checked again.



> To position the needle in the center of the embroidery design, tap «Center of Embroidery Design».

> To move the embroidery design horizontally, turn the «Upper Multi-function Knob».

> To move the embroidery design vertically, turn the «Lower Multi-function Knob».

Endless Embroidery

When embroidering a trim, it is advantageous to use the Mega Embroidery Hoop (optional accessory) or the Maxi Embroidery Hoop (optional accessory). The embroidering project therefore does not have to be re-clamped as frequently. We recommend marking guide lines on the fabric and using the pattern when clamping and re-clamping in the hoop. In doing so, the guide lines must run parallel to the pattern. The following example, the supplied Oval Hoop is used.

> Select the embroidery design.

> Tap «i-Dialog».



> Tap «Endless Embroidery».

– The embroidery design is duplicated to the optimum number, suitable for the hoop.

– The reference points, which are required when re-clamping the fabric, are inserted.

> If required, use the arrow icons (1) to insert additional reference points.

> To set the number of embroidery designs, tap «Minus»/«Plus» (2).

> To specify the distance between the embroidery designs, tap «Minus»/«Plus» (3).



> To automatically fit all embroidery designs into the hoop, tap «Adapting the Embroidery Design Size to the Hoop» (4).

- > Tap «Confirm».

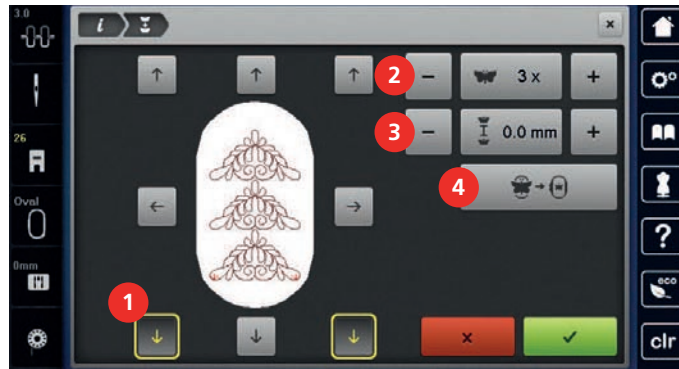

- > Tap «i-Dialog».

- > Tap «Embroidery».

- > Press the button «Start/Stop» and embroider the trim.
 - The embroidery design must be embroidered already.



- > After the reference points have been embroidered, tap «Endless Embroidery».
 - An animation displays that the fabric has to be re-clamped.

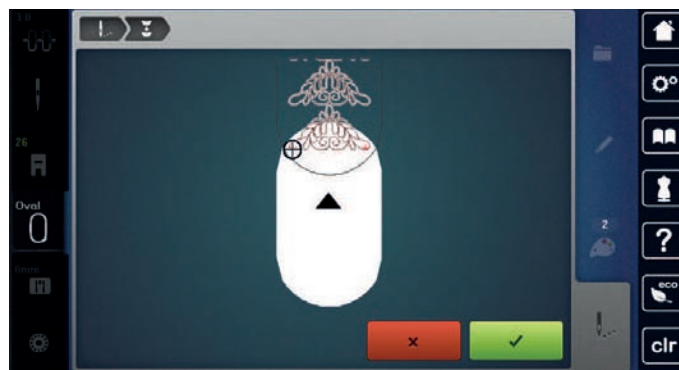

- > Remove the hoop and spin the fabric in such a way that the embroidered reference points are in the upper embroidery field of the hoop and the reference points are located at least 3 cm (1.18 inch) away from the upper edge of the hoop.

- > Attach the hoop.

- > Tap «Confirm».
 - The hoop is automatically moved close to the reference point.
 - The icon «AUTO» is active and the hoop automatically moves close to the last reference point.

- > Use the arrow icons to determine the side of the embroidered section on which you want to position the next reference point.



- > To position the embroidery hoop precisely, turn the «Upper Multi-function Knob» or «Lower Multi-function Knob».

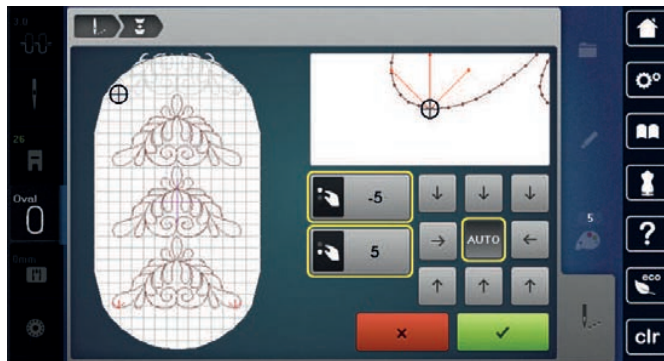

- ✓ > Tap «Confirm».
- ⏻ > Press the button «Start/Stop» and continue embroidering.
- > Repeat these steps until the required length of the trim has been achieved.

Duplicating the embroidery motif

- > Select an embroidery motif.
- > Tap «i-Dialog».



- 🗑️ > Tap «Duplicating».
- The embroidery motif (1) is duplicated (2).

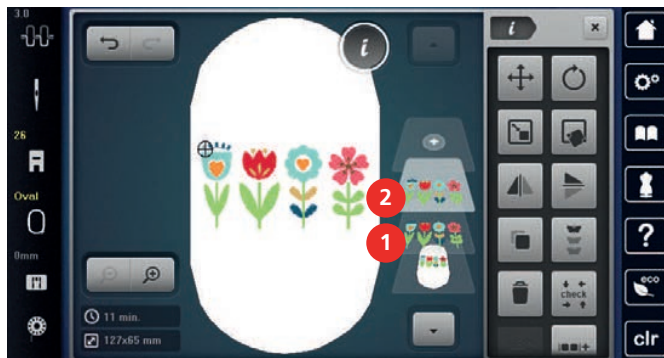

Deleting an Embroidery Design

The active embroidery design is deleted.

- > Select the embroidery design.
- > Tap «i-Dialog».



- 🗑️ > Tap «Deleting».

Changing the sequence within an embroidery motif combination

The sequence of the embroidery motifs in the embroidery motif combination can be changed.

Prerequisite:

- The embroidery motif combination has been created or the motif has been ungrouped.



- 🔄 > Tap «Change Embroidery Motif Sequence».
- > Select the required embroidery motif and move it to the corresponding position.

Undoing entries

All entries can be undone step by step and restored as well.

Prerequisite:

- An embroidery design is selected and alterations have been made.



- > To undo the last entry, tap «Undo Entries».
- > To undo the last entries in sequence, tap «Undo Entries» several times.



- > To restore the last entry, tap «Redo Entries».
- > To restore the last entries in sequence, tap «Redo Entries» several times.

Grouping embroidery motifs

Embroidery motifs can be added to or removed from a group. The grouped embroidery motifs can be processed in the same way as for one embroidery motif.

The sequence of the embroidery motifs in the group can be changed. (see page 66)

If the grouping of a embroidery motif has been canceled, i.e. the embroidery motif has been broken down into different elements/colors, the colors are no longer combined for new groupings. With alphabets, the length of the connecting stitches must first be set to 1 in the setup. The cancellation of the group then works for all letters.

- > Create an embroidery motif combination.
- > Select the embroidery motif (1) in the embroidery motif combination.

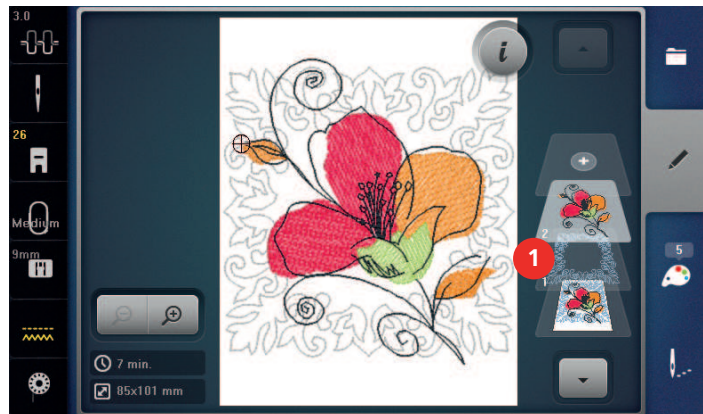

- > Tap «i-Dialog».



- > Tap «Group Embroidery Motifs».



- > Tap «Group».
 - Embroidery motifs above the selected embroidery motif are added to the embroidery motif group.
- > Select the embroidery motif group.



- > Tap «Ungroup».
 - The grouping is canceled.

or

- > Create an embroidery motif combination.

- > Select all embroidery motifs (2).

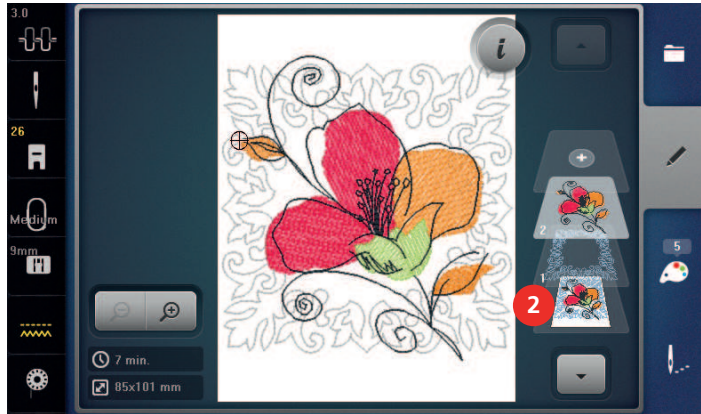

- > Tap «i-Dialog».



- > Tap «Group».
 - All embroidery motifs are added to the embroidery motif group.
- > Select the embroidery motif group.



- > Tap «Ungroup».
 - The grouping is canceled.

5.6 Pinpoint Placement

Positioning of grid points

This function allows the exact positioning of the embroidery design on the fabric in an easy way. The positioning points can be placed in the grid.

Prerequisite:

- Any two points of the embroidery design are marked with chalk or a water-soluble pen on the fabric. The place or the location where the embroidery design is to be positioned is clearly visible.
- The hoop in use is selected.

- > Select the embroidery design.
- > Tap «i-Dialog».



- > Tap «Pinpoint Placement».



- > Tap «Grid Point Positioning».
 - The embroidery design is given a grid with nine different location/positioning points.
- > Select the desired positioning point to which the embroidery design is to be adjusted.
 - The point changes color.

- > Turn the «Upper Multi-function Knob» or the «Lower Multi-function Knob» to the left or to the right to position the needle above the respective mark on the fabric.



- > To confirm the changed position, tap «Set».
 - The point changes color and is set.
- > Select the second positioning point of the embroidery design.

- > Turn the «Upper Multi-function Knob» or the «Lower Multi-function Knob» to the left or to the right to position the needle above the respective mark on the fabric.

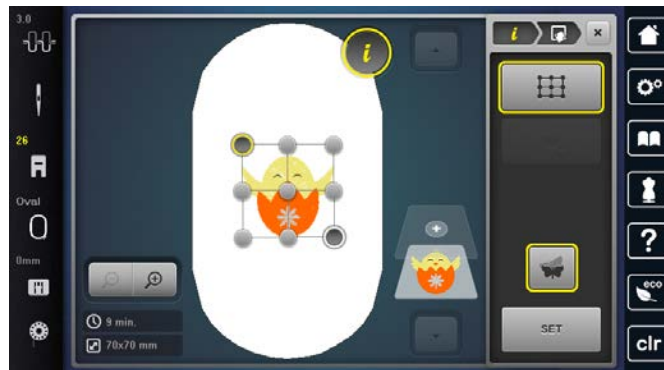

- > To confirm the changed position, tap «Set».
 - The point changes color and is set. The embroidery design is adjusted accordingly.
- > To reset the changes and revert to the default settings, tap «Reset Pinpoint Placement».



Free point positioning

This function allows the exact positioning of the embroidery design on the fabric in an easy way. The points can be defined as you like within the embroidery design.

Prerequisite:

- Any two points of the embroidery design are marked with chalk or a water-soluble pen on the fabric. The place or the location where the embroidery design is to be positioned is clearly visible.
- The hoop in use is selected.

- > Select the embroidery design.
- > Tap «i-Dialog».



- > Tap «Pinpoint Placement».



- > Tap «Free Point Positioning».
- > Define a desired point within the embroidery design.
 - The positioning point is displayed.



- > Turn the «Upper Multi-function Knob» or the «Lower Multi-function Knob» to the left or to the right to position the needle above the respective mark on the fabric.

- > To confirm the changed position, tap «Set».
 - The point changes color and is set.



- > Select the second positioning point of the embroidery design.
- > Turn the «Upper Multi-function Knob» or the «Lower Multi-function Knob» to the left or to the right to position the needle above the respective mark on the fabric.



- > To confirm the changed position, tap «Set».
 - The point changes color and is set. The embroidery design is adjusted accordingly.



- > To reset the changes and revert to the default settings, tap «Reset Pinpoint Placement».

5.7 Combining Embroidery Designs

Combining Embroidery Designs

In the Combi-mode several embroidery designs can be combined.

- > Select the embroidery design.
- > Tap «Adding an Embroidery Design».



- > Select another embroidery design.

Deleting a Single Embroidery Design

Prerequisite:

- A combination of embroidery designs has been created.
- > Tap the desired embroidery design in the area of the embroidery design level (1), keep it touched and drag it outwards.
 - A new window opens.

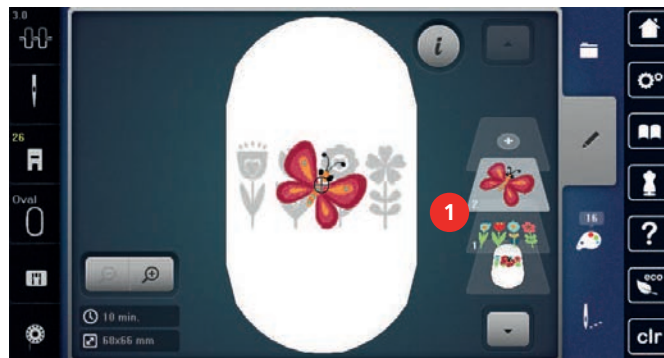

- > To delete the selected embroidery design, tap «Confirm».

Duplicating the embroidery motif

- > Select an embroidery motif.
- > Tap «i-Dialog».



- > Tap «Duplicating».
- The embroidery motif (1) is duplicated (2).

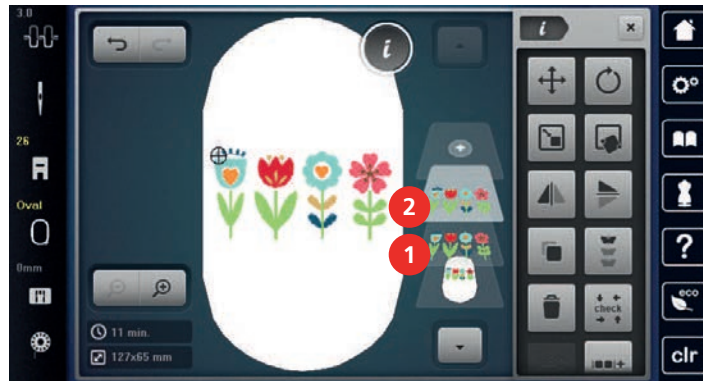

Duplicating a combination

When a combination is duplicated, the individual embroidery motifs cannot be selected anymore.

- > Select an embroidery motif.
- > Tap «Adding an Embroidery Design».
- > Select another embroidery motif.
- > Select the combination (1).



- > Tap «i-Dialog».



- > Tap «Duplicating».
- The combination is duplicated (2).

5.8 Creating Lettering

Overview embroidery alphabets

Embroidery motif		Name
ABC	A B C	Drifter
ABC	A B C	Childs Play

Embroidery motif		Name
ABC		Victoria
ABC		Condensed Sans
ABC		Flare Serif
ABC		Deco block
<i>ABC</i>		Curly
ABC		Rounded Sans
<i>ABC</i>	<i>A B C</i>	Anniversary
ABC		Bamboo
<i>ABC</i>		Lisa
<i>ABC</i>		Zürich
ABC	A B C	Swiss Block
ABC		Quilt Block
ABC		Old English
АБВ	A B B	Russian Textbook
ABC		Happy Times
ABC		Chicago



Creating Lettering



- | | | | |
|---|-------------------------|---|---------------------------------------|
| 1 | Entry Field | 5 | «Numbers and Mathematical Characters» |
| 2 | «Deleting» | 6 | «Special Characters» |
| 3 | «Upper Case Characters» | 7 | «Cancel» |
| 4 | «Lower Case Characters» | 8 | «Confirm» |



A lettering is always embroidered in one color. To embroider individual letters or individual words in a different color, the grouping must be canceled.

Lettering can be positioned within the hoop as you like. When the embroidery design is positioned outside the area to be embroidered, the hoop is outlined in red on the display. By means of the hoop selection it is possible to check whether or not the embroidery design can be embroidered in another hoop. If a lettering does not fit into one hoop, individual words can be combined and positioned one below one another, for example.



- > Select «Alphabets».
- > Select an alphabet.
- > Enter and confirm the text.

Editing the Lettering



- > A lettering has been created.
- > Tap «i-Dialog».



- > Tap «WordArt».
- > To change the distance between the characters in increments of one millimeter, turn the «Upper Multi-function Knob».
- > Turn the «Lower Multi-function Knob» to the left or right to curve the writing upwards or downwards.

5.9 Changing the Colors of the Embroidery Design

Overview changing the color

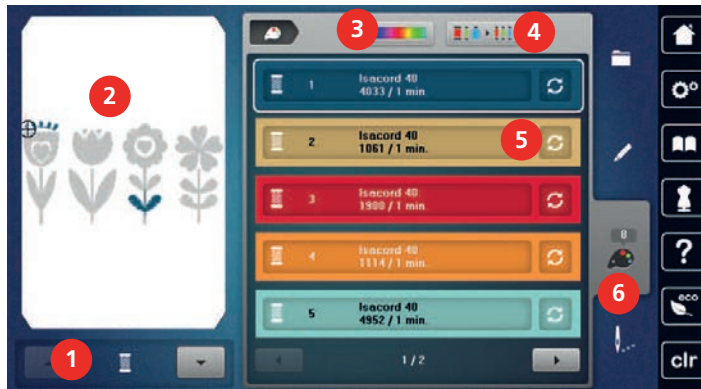





- | | | | |
|---|----------------------------|---|------------------------|
| 1 | «Color Indication» | 4 | «Assign Thread Brand» |
| 2 | Preview for Selected Color | 5 | «Altering Color/Brand» |
| 3 | «Color Wheel» | 6 | «Color Information» |

Changing the colors



A lettering is always embroidered in one color. To embroider individual letters or individual words in a different color, the grouping must be canceled.

- > Select the embroidery design.
 - > Tap «Color Information».
- 
- > Tap «Altering Color/Brand» next to the color that needs to be changed.
- 
- > To select the color by entering the color number, tap «Color Selection via Number».
 - > Select the desired color.
- 
- > To apply the color choice, tap «Color Information».
- 

Altering the colors via the color wheel

- 
- > Tap «Color Information».
 - > Tap «Color Wheel» (1).

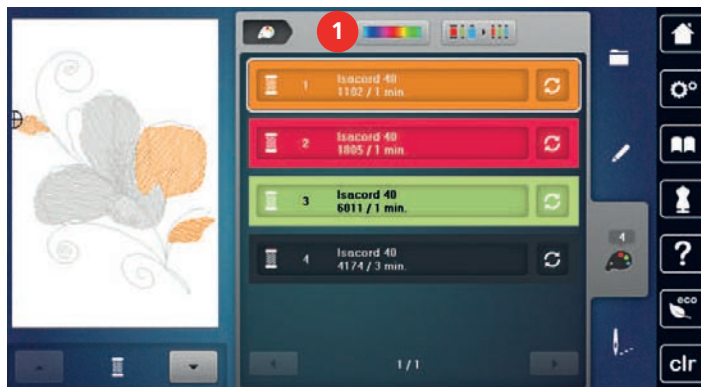

- > To change the colors of the embroidery design, turn the knob (2) clockwise or counterclockwise.

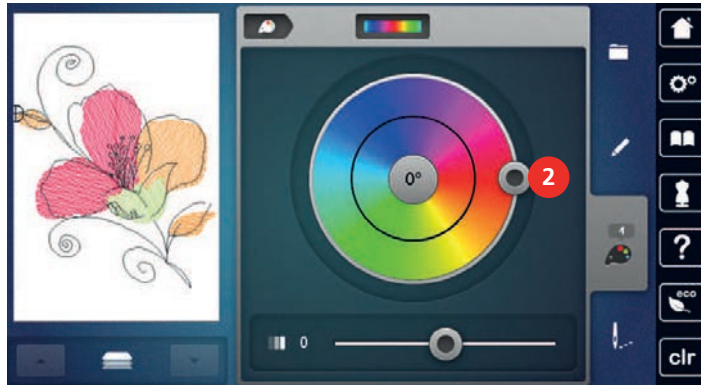

- > To undo the changes, tap the value in the center of the color circle.
- > To modify the brightness of the colors, move the slider (3).

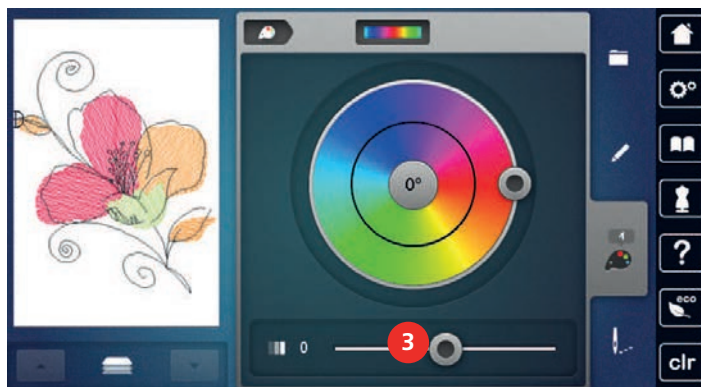

- > Tap «Edit».
 - The settings are applied, and the embroidery design can be seen in the new colors.

Changing the Thread Brand



- > Select the embroidery design.
- > Tap «Color Information».



- > Tap «Altering Color/Brand».
- > To display other thread brands, scroll to the left and to the right.



- > Tap «Assign Thread Brand».
 - Any thread colors of the selected embroidery design will be matched with the selected thread brand.

5.10 Embroidering the Embroidery Design

Overview Embroidery menu

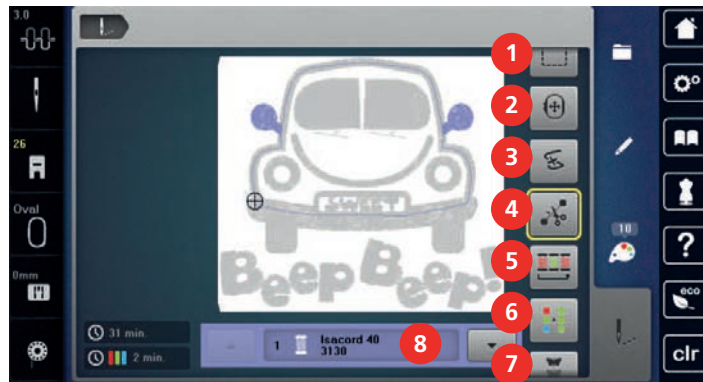

- | | | | |
|---|-------------------------------|---|--|
| 1 | «Basting» | 5 | «Reduce Color Changes» |
| 2 | «Moving the Hoop» | 6 | «Multi-colored Embroidery Design On/Off» |
| 3 | «Embroidery Sequence Control» | 7 | «Endless Embroidery» |
| 4 | «Cut Connecting Stitches» | 8 | «Color Indication» |

Adding Basting Stitches

The basting stitches can be embroidered along the embroidery design. As a result, the fabric and the stabilizer are better fixed together.

- > Select the embroidery design.
- > Tap «Embroidery».



- > To embroider the basting stitches along an embroidery design, tap «Basting».
- > To embroider the basting stitches along the hoop, tap «Basting» again.
- > To deactivate the basting stitches, tap «Basting» again.

Moving the Hoop

If the embroidery design is so big that repeated rehooping is necessary, the embroidered design can be moved again.

- > Select the embroidery design.
- > Tap «Embroidery».



- > Tap «Moving the Hoop».
- > Turn the «Upper Multi-function Knob» to move the embroidery design horizontally.
- > Turn the «Lower Multi-function Knob» to move the embroidery design vertically.
- > To accept the settings, tap «Embroidery» in the Process Navigation.



Embroidery sequence control when thread breaks

If the thread breaks, the needle can be repositioned in the embroidery design using the function Embroidery Sequence Control.

- > Select the embroidery design.
- > Tap «Embroidery».





> Tap «Endless Embroidery».

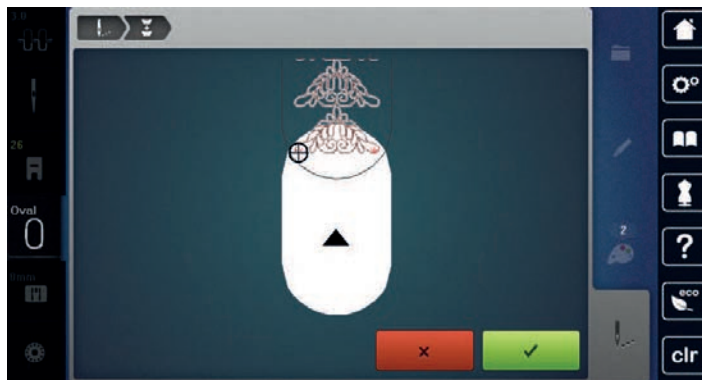

> Remove the hoop and spin the fabric in such a way that the embroidered reference points are in the upper embroidery field of the hoop and the reference points are located at least 3 cm (1.18 inch) away from the upper edge of the hoop.

> Attach the hoop.



> Tap «Confirm».

– The hoop is automatically moved close to the last stitch.

– The icon «AUTO» is active and the hoop automatically moves close to the last reference point.

> Use the arrow icons to determine the side of the embroidered section on which you want to position the next reference point.

> To position the embroidery hoop precisely, turn the «Upper Multi-function Knob» or the «Lower Multi-function Knob».

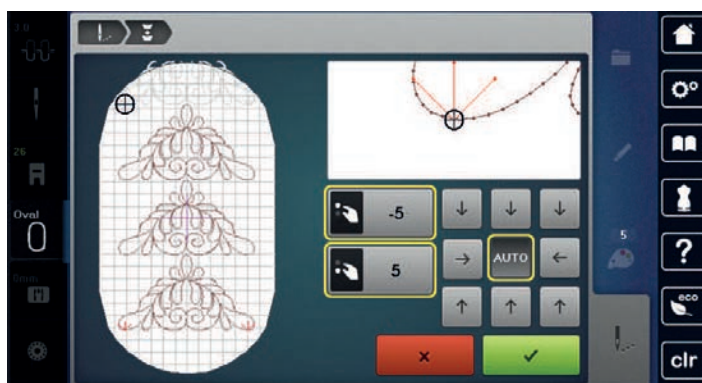

> Tap «Confirm».



> Press the button «Start/Stop» and continue embroidering.

> Repeat these steps until the required length of the trim has been achieved.

Color Indication

Every color of the embroidery design can be selected individually. The hoop moves to the first stitch of the current color. The currently active color can be embroidered individually or in another sequence.

> Select the embroidery design.



> Tap «Embroidery».

> Touch the icon Scroll up to select the previous color of the embroidery design.

5.11 Frearm Embroidery

Free arm embroidering is defined as embroidering tubular fabrics or garments which are positioned around the free arm of the embroidery machine while being embroidered. Often used with sleeves, pant legs or other narrow-tailored garments.



A fabric tube can be conveniently placed around the freearm of the machine if the embroidery hoop is moved to the left into the park position before attaching or removing it. To return the hoop to the embroidery position afterwards, push the button «Start/Stop».

If possible, use a full bobbin as the embroidery hoop must be removed when the bobbin is changed.

Borders can be closed easily and exactly along the edge of the tube to form a ring. Before working out the last embroidery design, after rehooping the fabric, activate the function «Pinpoint Placement» in the Edit Mode. Use the sub-function «Free Point Positioning» to insert the missing embroidery design for a perfect fit.

The movability of the embroidery arm can be limited or impeded with very narrow tubes. Therefore please make sure that the embroidery hoop can move forwards and backwards sufficiently. An impediment of the embroidery arm caused by a tube which is too tight can result in embroidery design offset or in damaging the fabric.

Check the Movability of the Freearm

Please note: With tiny fabric tubes, deactivate the thread-away in the Setup Program if necessary.

- > Open the embroidery design on the machine and edit as desired.
- > Mark the embroidery design position and the size on the fabric in a suitable way.
- > Select the embroidery hoop as small as possible.
- > Hoop or stick the fabric along with the appropriate stabilizer in the embroidery hoop, depending on the stabilizer.
- > Pull the fabric tube carefully over the freearm of the machine and attach the embroidery hoop at the clutch of the embroidery module.
- > If necessary, reposition the embroidery design.
- > Tap «Check Embroidery Design Size».
- > After the successful check of the embroidery design size, start the embroidery process.



5.12 Administering Embroidery Designs

Administering Embroidery Designs

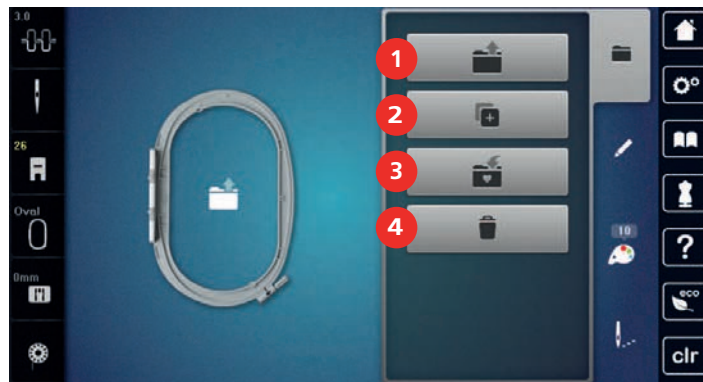



- | | | | |
|---|---------------------------------|---|---------------------------------|
| 1 | «Loading the Embroidery Design» | 3 | «Save Embroidery Design» |
| 2 | «Adding an Embroidery Design» | 4 | «Deleting an Embroidery Design» |

Saving Embroidery Designs in the Personal Memory





In the file «Save Embroidery Designs» any embroidery designs including individually edited embroidery designs can be saved.

- > Select the embroidery design.
- > Edit the embroidery design.
- > Tap «Selection».







-  > Tap «Save Embroidery Design».
 - The embroidery design to be saved is outlined in yellow.
-  – The «Embroidery Machine» is activated.
-  > Tap «Confirm».





Saving the Embroidery Design on the BERNINA USB Stick

- > Select the embroidery design.
- > Edit the embroidery design.
-  > Tap «Selection».
-  > Tap «Save Embroidery Design».
 - The embroidery design to be saved is outlined in yellow.
- > Insert the BERNINA USB stick into the USB port of the machine.
-  > Tap «USB Stick».
-  > Tap «Confirm».



Overwriting the Embroidery Design in the Personal Memory

- > Select the embroidery design.
- > Edit the embroidery design.
-  > Tap «Selection».
-  > Tap «Save Embroidery Design».
 - The embroidery design to be saved is outlined in yellow.
-  – The «Embroidery Machine» is activated.
- > Select the embroidery design which is to be overwritten.
-  > Tap «Confirm».

Overwriting the Embroidery Design on the BERNINA USB Stick





- > Select the embroidery design.
- > Edit the embroidery design.
-  > Tap «Selection».
-  > Tap «Save Embroidery Design».
 - The embroidery design to be saved is outlined in yellow.
- > Insert the BERNINA USB stick into the USB port of the machine.
-  > Tap «USB Stick».
- > Select the embroidery design which is to be overwritten.
-  > Tap «Confirm».

Loading an Embroidery Design from the Personal Memory

-  > Tap «Selection».
-  > Tap «Loading the Embroidery Design».
-  > Select «Personal Embroidery Design».
- > Select the embroidery design.







Loading an Embroidery Design from the BERNINA USB Stick







-  > Tap «Selection».
-  > Insert the BERNINA USB stick into the USB port of the machine.
-  > Tap «Loading the Embroidery Design».
-  > Tap «USB Stick».
-  > Select a personal embroidery design.

Deleting an Embroidery Design from the Personal Memory

The embroidery designs which are saved in the personal memory can be deleted individually.

-  > Tap «Selection».
-  > Tap «Deleting».
-  – The «Embroidery Machine» is activated.
-  > Select the embroidery design which is to be deleted.
-  > Tap «Confirm».



Deleting an Embroidery Design from the BERNINA USB Stick

-  > Tap «Selection».
-  > Tap «Deleting».
-  > Insert the BERNINA USB stick into the USB port of the machine.
-  > Tap «USB Stick».
-  > Select the embroidery design which is to be deleted.
-  > Tap «Confirm».

6 Embroidery

6.1 Embroidering via the button «Start/Stop»

In case of a power cut the embroidery process is interrupted. After the restart the machine goes to the position which was embroidered last.

- 
 - > Push the button «Start/Stop» until the embroidery machine starts.
 - All parts of the design being in the current color are embroidered.
 - The embroidery machine stops automatically at the end.
 - Both threads are cut automatically.
 - The embroidery machine switches to the next color automatically.
- 
 - > Change the upper thread.
 - > To embroider the new color, push the button «Start/Stop».
 - > After completing the embroidery design, finish the embroidering process by tapping the icon «Completing the Embroidering Process» (1) or embroider the embroidery design again as trim by tapping the icon «Endless Embroidery» (2).

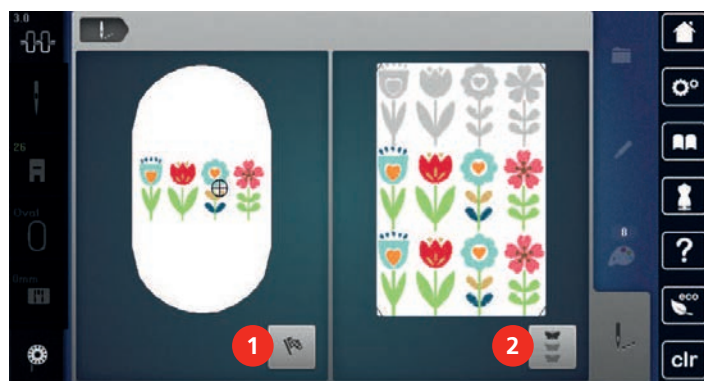

6.2 Increasing the Embroidery Speed

To ensure the best embroidery quality, the speed when embroidering is reduced depending on the embroidery position. Choose between the two options to either embroider at optimal or maximum speed. Standard = optimal speed. It has to be considered that the quality of the embroidered embroidery design at maximum speed cannot be ensured.

By switching the machine off and on, the optimal embroidery speed is activated.

Prerequisite:

- Embroidering has started.
- 
 - > Tap «Embroidery Speed».
 - The maximum speed is activated.
 - > Tap «Embroidery Speed» again.
 - The optimal speed is activated.

6.3 Adjusting the upper thread tension

The default setting of the upper thread tension is set automatically as soon as a embroidery design is selected.

The upper thread tension is set optimally at the BERNINA factory and the machine has been tested. Metrosene/Seralon thread size 100/2 (Mettler, Switzerland) is used for the upper and bobbin thread.

When using different types of embroidery threads, the upper thread tension may vary. It may therefore be necessary to adjust the upper thread tension individually according to the embroidery project as well as the desired embroidery design.

The higher the upper thread tension is set, the tighter the upper thread is tensioned, and the bobbin thread is pulled deeper into the fabric. When the upper thread tension is low, the upper thread is less tightened, and the bobbin thread is pulled up less into the fabric.

Alteration of the upper thread tension affect all embroidery designs. Permanent alterations of the upper thread tension can be made in the Setup Program (see page 50).



- > Tap «Upper Thread Tension».
- > Adjust the upper thread tension.

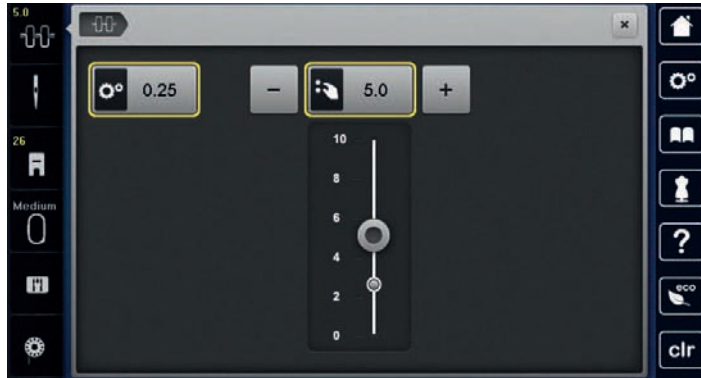

- > Tap the yellow-framed icon to reset the changes to the default setting.
- > Tap the yellow-framed icon on the left side to reset the alterations in the «Setup Program» to the default setting.

6.4 Embroidering via the foot control (Optional accessory)

Embroidering with the foot control is recommended if small sequences are to be embroidered, e. g. for stumpwork.

- > To start embroidering, press and keep the foot control pressed.

7 Care and Maintenance

7.1 Firmware

Restoring saved data

If personal data and settings are not available after a software update, they can be transferred to the machine again afterwards.

- > Insert the USB stick with the saved data and settings into the USB port of the machine.
- > Tap «Home».



- > Tap «Setup Program».



- > Tap «Machine Settings».



- > Tap «Maintenance/Update».



- > Tap «Updating Firmware».



- > Tap «Load Data».
- > Wait until the data has been fully transferred.



NOTICE

BERNINA USB Stick (Optional Accessory) has been removed too early

Saved data cannot be transferred and the machine cannot be used.

- > Remove the BERNINA USB stick (optional accessory) only after the saved data has been transferred successfully.

- > Remove the USB stick.

Checking the firmware version

The firmware and hardware versions of the machine and the connected embroidery module are displayed.

- > Tap «Setup Program».



- > Tap «Machine Settings».



- > Tap «Information».



- > Tap «Machine Data».







Updating firmware



The machine's current firmware and detailed step-by-step instructions for the update process can be downloaded from www.bernina.com. In general, personal data and settings are automatically transferred during a firmware update. For reasons of safety, it is also recommended to save data and settings on a BERNINA USB stick before the firmware update is started. If personal data and settings should get lost during a firmware update, they can be transferred to the machine again afterwards.

Prerequisite:

- Accessories such as the Embroidery module or the BSR Foot which are connected to the machine have been removed.

- > Insert the USB stick with the new firmware version into the machine.
 - > Tap «Setup Program».
 -  > Tap «Machine Settings».
 -  > Tap «Maintenance/Update».
 -  > Tap «Updating Firmware».
 -  > To start the firmware update, tap «Update».
- Please note:** The update can take several minutes. During the update, do not switch the machine off and do not remove the USB stick.
- The machine restarts. Once the update is complete, a message appears.

7.2 Machine

Cleaning the Display

- > Clean the display when it is switched off with a soft slightly damp microfiber cloth.

Removing thread remnants under the stitch plate



Electronically Driven Components

Risk of injury near the needle and the hook.

- > Switch the machine off and disconnect it from the power supply system.

Remove the thread remnants under the stitch plate regularly.

- > Remove the presser foot and the needle.
- > Remove the stitch plate.



- > Remove the thread remnants under the stitch plate.

Cleaning the Hook



Electronically Driven Components

Risk of injury near the needle and the hook.

- > Switch the machine off and disconnect it from the power supply system.

- > Open the hook cover.
- > Remove the bobbin case.

- > Push the release bracket to the left.



- > Flap down the fastening bracket along with the black hook race cover.
- > Remove the hook.

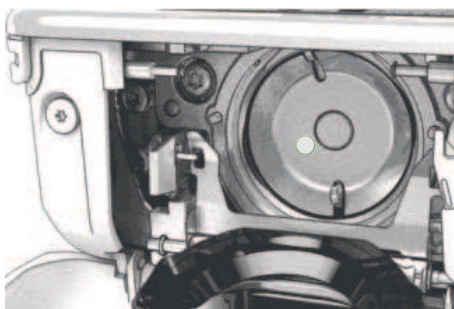

NOTICE

Dust and Thread Residues Inside the Machine

Damage to mechanical and electronic components.

- > Use a brush or a soft cloth.
- > Do not use compressed air spray.

- > Clean the hook race area with a brush and a soft cloth. Never use any sharp instruments.
- > Hold the hook at the pin in the center with two fingers.
- > Guide the hook with the lower edge diagonally from the top to the bottom behind the hook race cover.
- > Position the hook so that the two lugs on the hook driver fit into the corresponding openings on the hook, and the colored marking on the hook driver is visible in the hole of the hook.
- > Insert the hook.
 - The hook is magnetic and therefore fastened to the correct position.
- > Close the hook race cover and the fastening bracket until the release bracket engages.
- > As a check, turn the handwheel.
- > Insert the bobbin case.

Lubricating the Hook

By oiling the hook, the occurrence of unwanted noises in the hook area can be avoided. BERNINA recommends oiling the hook at the following intervals:

- Before using the machine for the first time
- After a longer downtime of the machine
- For intensive use: Daily before sewing
- When the message " Lubricate the Machine " is displayed
- In case of unwanted noises in the hook area

CAUTION

Electronically Driven Components

Risk of injury near the needle and the hook.

- > Switch the machine off and disconnect it from the power supply system.

- > Remove the bobbin case.

Cleaning the thread catcher



> Tap «Setup Program».



> Tap «Machine Settings».



> Tap «Maintenance/Update».









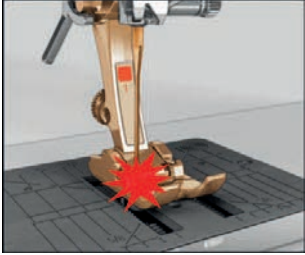

> Tap «Cleaning the Thread Catcher».
> Clean the thread catcher according to the instructions on the display.



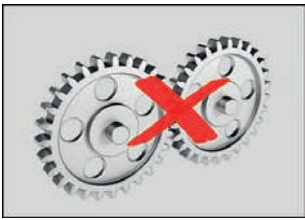
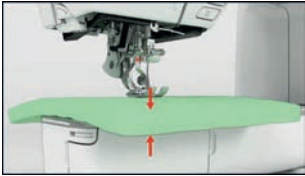

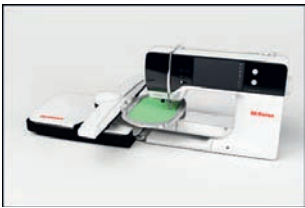
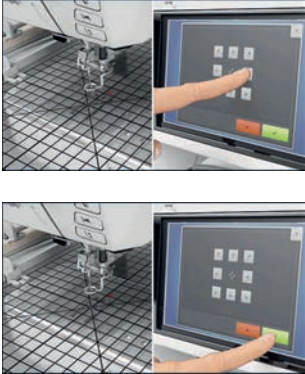
8 Errors and Faults

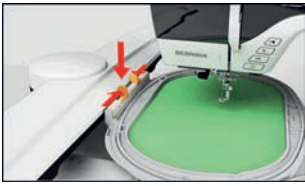
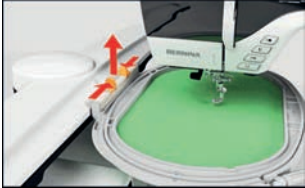
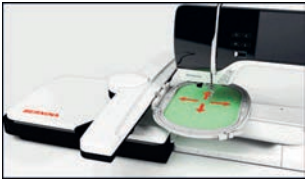
8.1 Error messages

Message on the Display	Cause	Solution
	The selected needle and stitch plate cannot be used in combination.	<ul style="list-style-type: none"> > Replace the needle. > Replace the stitch plate.
	The needle is not at its top end.	<ul style="list-style-type: none"> > Adjust the needle position via the handwheel.
	The upper thread is used up.	<ul style="list-style-type: none"> > Rethread.
	The upper thread has broken.	<ul style="list-style-type: none"> > Rethread.
	The bobbin thread is used up.	<ul style="list-style-type: none"> > Rethread.
	The bobbin thread has broken.	<ul style="list-style-type: none"> > Clean the hook. > Rethread.
	The main motor is not running.	<ul style="list-style-type: none"> > Turn the handwheel clockwise until the needle is at its top position. > Remove the sewing project. Do not pull on the fabric or the thread. > Remove the stitch plate. > Remove the thread remnants. > Clean the hook. > Remove the hook and make sure that there are no pieces of broken needle points on the magnetic back of the hook. > Insert the hook correctly.
	The fabric under the presser foot is too thick.	<ul style="list-style-type: none"> > Reduce the fabric thickness.

Message on the Display	Cause	Solution
	The contact between the machine and the embroidery module is interrupted as a result of vibrations.	<ul style="list-style-type: none"> > Make sure that the embroidery module and the machine are standing on a stable, even surface. > Connect the embroidery module to the machine.
	The needle position doesn't correspond with the center of the hoop.	<ul style="list-style-type: none"> > Calibrate the hoop.
	The embroidery module is not attached.	<ul style="list-style-type: none"> > Connect the embroidery module to the machine. > Contact the specialized BERNINA dealer to have the machine checked.
	The hoop is not attached.	<ul style="list-style-type: none"> > Attach the hoop.
	The hoop is attached.	<ul style="list-style-type: none"> > Remove the embroidery hoop.
	The movement of the hoop follows.	<ul style="list-style-type: none"> > Tap «Confirm».
	The embroidery design is partly outside the hoop.	<ul style="list-style-type: none"> > Reposition the embroidery design and start embroidering it again.

Message on the Display	Cause	Solution
	<p>The embroidery design is too large.</p>	<ul style="list-style-type: none"> > Reduce the size of the embroidery design. > Attach a larger hoop.
<p>Not enough free capacity on the BERNINA USB stick (optional accessory).</p>	<p>There is not enough free capacity on the BERNINA USB stick (optional accessory).</p>	<ul style="list-style-type: none"> > Make sure that the BERNINA USB stick (optional accessory) is used. > Delete data from the BERNINA USB stick (optional accessory).
<p>No personal data on the BERNINA USB stick (optional accessory).</p>	<p>No personal data for recovery available on the BERNINA USB stick (optional accessory).</p>	<ul style="list-style-type: none"> > Make sure that the data and settings have been saved on the BERNINA USB stick (optional accessory).
<p>The recovery of personal data has failed.</p>	<p>The firmware update has been successful but the personal data could not be recovered.</p>	<ul style="list-style-type: none"> > Make sure that the data and settings have been saved on the BERNINA USB stick. > Transfer saved data to the machine.
<p>No BERNINA USB stick is inserted. Make sure that the same BERNINA USB stick remains connected during the entire automatic update process.</p>	<p>The BERNINA USB stick (optional accessory) is not inserted.</p>	<ul style="list-style-type: none"> > Use a BERNINA USB stick (optional accessory) which provides enough free capacity.
<p>The firmware update has failed.</p>	<p>The latest firmware version cannot be found on the USB stick.</p>	<ul style="list-style-type: none"> > Make sure that the compressed zip file has been unzipped for the firmware update. > Check whether the data for the software update is saved directly on the data medium and not in a file on the USB stick. > Updating Firmware.
	<p>The machine must be cleaned/ lubricated.</p>	<ul style="list-style-type: none"> > Clean the machine. > Lubricate the machine. <p>Important information on lubricating:</p> <ul style="list-style-type: none"> > Too much oil may stain the fabric and the thread. > After lubricating, always embroider on a test piece.

Message on the Display	Cause	Solution
The automatic thread cutter (at the thread catcher) needs cleaning.	The automatic thread cutter needs cleaning. The message appears every time when the machine is started as soon as 1000 cutting cycles have been carried out.	<ul style="list-style-type: none"> > Tap «Confirm». <ul style="list-style-type: none"> – The machine calls up the function «Clean the Thread Catcher». > Clean the thread catcher according to the instructions on the display. <ul style="list-style-type: none"> – The counter for the cutting cycles is reset.
It is time for the regular maintenance. Please contact your authorized BERNINA dealer to make an appointment.	<p>The machine needs maintenance. The message appears after the programmed service interval has expired.</p> <p>Important Information: Having your machine cleaned and serviced properly at the appropriate times ensures its proper functioning and a long service life. In case of non-compliance, the service life may be negatively affected and the warranty service may possibly become limited. The cost allocation for maintenance work is regulated nationally. Consult your authorized BERNINA dealer or your service center for more details.</p>	<ul style="list-style-type: none"> > Contact an authorized BERNINA dealer. > Delete the message temporarily by touching the icon «ESC». <p>After the third deletion, the message is not displayed until the next service interval is reached.</p>
#1000	The needle threader is jammed.	<ul style="list-style-type: none"> > Switch off the machine. Press the needle threader down and release it again. Switch the machine on. > If the error still occurs, contact your authorized BERNINA dealer.
#1001	The button «Thread Cutter» is stuck or defective.	<ul style="list-style-type: none"> > Make sure that the button can be operated without restriction. > If the error still occurs, contact your authorized BERNINA dealer.
#1003	The button «Start/Stop» is stuck or defective.	<ul style="list-style-type: none"> > Make sure that the button can be operated without restriction. > If the error still occurs, contact your authorized BERNINA dealer.
#1004 #1005 #1010	The exact cause of the malfunction cannot be determined.	<ul style="list-style-type: none"> > Restart the machine. > If the error still occurs, contact your authorized BERNINA dealer.



8.2 Troubleshooting

Fault	Cause	Solution
Uneven stitch formation	Upper thread too tight or too loose.	> Adjust the upper thread tension. > Check the thread feed from the thread spool.
	Needle blunt or bent.	> Replace the needle, make sure that a new BERNINA quality needle is used.
	Poor quality needle.	> Use a new BERNINA quality needle.
	Poor quality thread.	> Use quality thread.
	Incorrect needle/thread combination.	> Match the needle with the thread size.
	Incorrectly threaded.	> Rethread.
Uneven stitch formation	Incorrect bobbin case is used.	> Use supplied bobbin case.
Skipped stitches	Incorrect needle.	> Use the needle system 130/705H.
	Needle blunt or bent.	> Replace the needle.
	Poor quality needle.	> Use a new BERNINA quality needle.
	The needle is incorrectly inserted.	> Insert the needle with the flat side to the back as far up as it will go into the needle holder and tighten the screw.
	Incorrect needle point.	> Match the needle point to the texture of the material.
Faulty stitching	Thread remnants between the thread tension discs.	> Fold a piece of thin material and slide the folded edge (not the raw edges) between the thread tension discs.
	Incorrectly threaded.	> Rethread.
	Thread remnants below the bobbin case spring.	> Remove the thread remnants under the spring.

Fault	Cause	Solution
The machine doesn't start	Unfavorable room temperature.	<ul style="list-style-type: none"> > Place the machine in a warm room one hour before use. > Connect the machine and switch it on.
	The machine is damaged.	<ul style="list-style-type: none"> > Contact an authorized BERNINA dealer.
The light of the button «Start-/Stop» doesn't light up	Light is defect.	<ul style="list-style-type: none"> > Contact an authorized BERNINA dealer.
Neither the sewing light nor the light on the freearm lights up	The sewing light is deactivated.	<ul style="list-style-type: none"> > Tap «Switch Sewing Light On/Off».
	Settings in the Setup Program.	<ul style="list-style-type: none"> > Activate it in the Setup Program.
	The sewing light is defect.	<ul style="list-style-type: none"> > Contact an authorized BERNINA dealer.
Upper thread indicator fails to respond	Settings in the Setup Program.	<ul style="list-style-type: none"> > Activate it in the Setup Program.
	The upper thread indicator is defect.	<ul style="list-style-type: none"> > Contact an authorized BERNINA dealer.
Bobbin thread indicator doesn't react	Settings in the Setup Program.	<ul style="list-style-type: none"> > Activate it in the Setup Program.
	The bobbin thread indicator is defect.	<ul style="list-style-type: none"> > Contact an authorized BERNINA dealer.
Error during firmware update	USB stick is not recognized.	<ul style="list-style-type: none"> > Use the BERNINA USB stick.
	The update process is blocked and the hourglass on the display is inactive.	<ul style="list-style-type: none"> > Remove the USB stick. > Switch off the machine. > Switch the machine on. > Follow the instruction on the display.
	Firmware update files are not found.	<ul style="list-style-type: none"> > Unzip the update data. > Store data for the firmware update directly on the data medium and not in a folder on the USB stick.

9 Storage and Disposal

9.1 Storing the Machine

It is recommended to store the machine in the original packaging. If the machine is stored in a cold room, place it in a warm room one hour before use.

- > Switch the machine off and disconnect it from the power supply.
- > Don't store the machine outdoors.
- > Protect the machine against climatic influences.

9.2 Dispose of the Machine

- > Clean the machine.
- > Sort the components by their materials and dispose of them according to the local laws and regulations.



10 Technical data

Designation	Value	Unit
Maximum fabric thickness	12.5 (0.49)	mm (in)
Sewing light	30	LED
Maximum speed	1000	Stitches per minute
Measurements without the spool pin (W × H × D)	522 × 358 × 214 (20.55 × 14.09 × 8.43)	mm (in)
Weight	13.5 (29.76)	kg (lb)
Energy consumption	140	W
Input voltage	100 – 240	V
Protection class (Electrical engineering)	II	

11 Overview Stitch Patterns













11.1 Overview Embroidery Desings

Editing the Embroidery Design

Let your creativity run free. A vast selection of embroidery designs is at your disposal.







































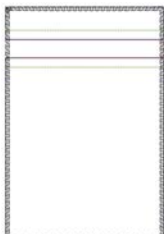

If you see one of the following pictograms below a number of the embroidery design, you can find additional information at

<https://www.bernina.com/specialeffects>.



	Detached Point		PunchWork
	Basic CutWork		Couching
	Fringe Embroidery		Projects in the Hoop
	Appliqué		Puffy Fonts
	CutWork		Quilting
	PaintWork		Trapunto
	CrystalWork		

Projects

You can find the detailed embroidery instructions at www.bernina.com/7seriesdesigns.















































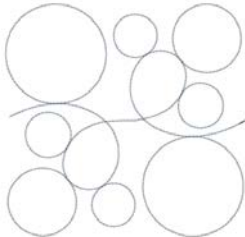

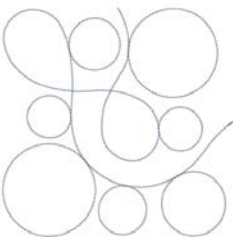







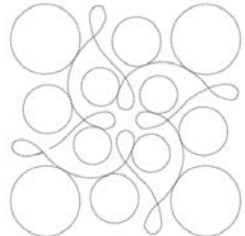

 BE700701  209 x 202 mm 8.2 x 7.9 inch  10.796	 12604-02  45 x 153 mm 1.8 x 6 inch  10.924
<ol style="list-style-type: none"> 1.  Isacord 40 0660 2.  Isacord 40 5500 3.  Isacord 40 3102 	<ol style="list-style-type: none"> 1.  Isacord 40 4610 2.  Isacord 40 4610 3.  Isacord 40 4531 4.  Isacord 40 4610 5.  Isacord 40 4740 6.  Isacord 40 0015 7.  Isacord 40 0800 8.  Isacord 40 1310 9.  Isacord 40 4610 10.  Isacord 40 4610 11.  Isacord 40 1310 
 12519-03  108 x 161 mm 4.3 x 6.4 inch  1.864	 19999-032  90 x 143 mm 3.6 x 5.6 inch  4.002
<ol style="list-style-type: none"> 1.  Isacord 40 5832 2.  Isacord 40 1902 3.  Isacord 40 3355 4.  Isacord 40 0020 	<ol style="list-style-type: none"> 1.  Isacord 40 0020 2.  Isacord 40 0020 3.  Isacord 40 9302 4.  Isacord 40 1154 5.  Isacord 40 9302 6.  Isacord 40 0020 

Quilt Designs

<p>Bd289  202 x 201 mm 7.9 x 7.9 inch  6.190</p>	<p>Bd285  202 x 201 mm 7.9 x 7.9 inch  6.531</p>
<p>1.  Isacord 40 4625</p> 	<p>1.  Isacord 40 1305</p> 
<p>Bd288  202 x 201 mm 7.9 x 7.9 inch  5.806</p>	<p>Bd292  95 x 95 mm 3.7 x 3.7 inch  3.036</p>
<p>1.  Isacord 40 0703</p> 	<p>1.  Isacord 40 3332</p> 
<p>Bd299  94 x 95 mm 3.7 x 3.7 inch  3.133</p>	<p>Bd308  95 x 94 mm 3.7 x 3.7 inch  3.763</p>
<p>1.  Isacord 40 0700</p> 	<p>1.  Isacord 40 1311</p> 
<p>Bd413_48  97 x 97 mm 3.8 x 3.8 inch  4.124</p>	<p>Bd837_48  123 x 123 mm 4.9 x 4.9 inch  1.629</p>
<p>1.  Isacord 40 5822</p> 	<p>1.  Isacord 40 0138</p> 
<p>12380-43  123 x 123 mm 4.9 x 4.9 inch  8.248</p>	<p>12380-30  89 x 96 mm 3.5 x 3.8 inch  4.442</p>
<p>1.  Isacord 40 1543</p> 	<p>1.  Isacord 40 1543</p> 



Overview Stitch Patterns

<p> 12380-04</p> <p> 83 x 90 mm 3.3 x 3.5 inch</p> <p> 2.189</p>	<p> 12380-08</p> <p> 89 x 89 mm 3.5 x 3.5 inch</p> <p> 2.725</p>
<p>1.  Isacord 40 1543</p> 	<p>1.  Isacord 40 1543</p> 
<p> 12380-09</p> <p> 112 x 62 mm 4.4 x 2.4 inch</p> <p> 1.945</p>	<p> 12380-22</p> <p> 110 x 61 mm 4.4 x 2.4 inch</p> <p> 2.487</p>
<p>1.  Isacord 40 1543</p> 	<p>1.  Isacord 40 1543</p> 
<p> 12380-10</p> <p> 152 x 357 mm 6 x 14 inch</p> <p> 24.674</p>	<p> Bd796_48</p> <p> 47 x 173 mm 1.9 x 6.8 inch</p> <p> 521</p>
<p>1.  Isacord 40 1543</p> 	<p>1.  Isacord 40 3654</p> 
<p> Bd800_48</p> <p> 126 x 122 mm 5 x 4.8 inch</p> <p> 609</p>	<p> Bd801_48</p> <p> 122 x 122 mm 4.8 x 4.8 inch</p> <p> 594</p>
<p>1.  Isacord 40 3654</p> 	<p>1.  Isacord 40 3654</p> 
<p> Bd804_48</p> <p> 123 x 124 mm 4.8 x 4.9 inch</p> <p> 904</p>	<p> Bd394_48</p> <p> 97 x 97 mm 3.8 x 3.8 inch</p> <p> 4.586</p>
<p>1.  Isacord 40 0111</p> 	<p>1.  Isacord 40 3641</p> 
<p> Bd412_48</p> <p> 89 x 53 mm 3.5 x 2.1 inch</p> <p> 1.427</p>	<p> Bd513_48</p> <p> 64 x 63 mm 2.5 x 2.5 inch</p> <p> 950</p>
<p>1.  Isacord 40 1335</p> 	<p>1.  Isacord 40 1532</p> 

Bd514_48 64 x 63 mm 2.5 x 2.5 inch 926

1. Isacord 40 1352



Bd553_48 114 x 121 mm 4.5 x 4.8 inch 5.845

1. Isacord 40 2153

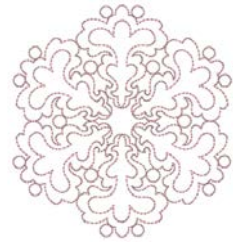

Bd567_48 108 x 108 mm 4.3 x 4.3 inch 4.359

1. Isacord 40 2530



Bd554_48 110 x 110 mm 4.3 x 4.3 inch 6.252

1. Isacord 40 2153

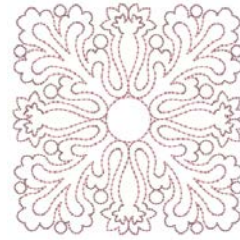

Bd659_48 66 x 219 mm 2.6 x 8.6 inch 2.378

1. Isacord 40 2910



Bd665_48 160 x 118 mm 6.3 x 4.6 inch 2.834

1. Isacord 40 2910

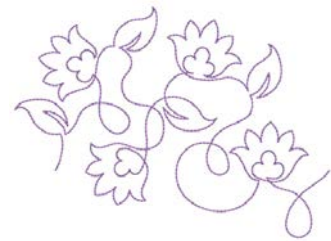

He959_48 121 x 121 mm 4.8 x 4.8 inch 2.473

1. Isacord 40 1902



Borders and Lace

82011-30 107 x 130 mm 4.2 x 5.1 inch 17.281

1. Isacord 40 0660
2. Yenmet 7013







































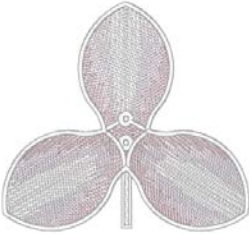









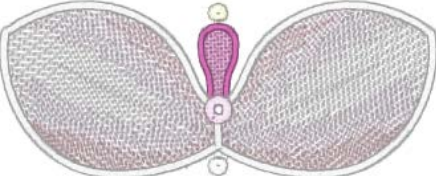









































































82011-28 134 x 99 mm 5.3 x 3.9 inch 23.505

1. Isacord 40 0660
2. Yenmet 7013



































Overview Stitch Patterns











































Nb952_48	 108 x 119 mm 4.3 x 4.7 inch	 22.514	 Oc00303	 101 x 110 mm 4 x 4.4 inch	 35.018
<ol style="list-style-type: none"> 1.  Isacord 40 0020 2.  Isacord 40 4174 3.  Isacord 40 0020 4.  Isacord 40 4174 5.  Isacord 40 0761 		<ol style="list-style-type: none"> 1. Isacord 40 0015 			
 12410-08		 80 x 168 mm 3.2 x 6.6 inch		 22.500	 12410-07
<ol style="list-style-type: none"> 1.  Isacord 40 1874 		<ol style="list-style-type: none"> 1.  Isacord 40 1874 			
 12410-15		 29 x 133 mm 1.1 x 5.3 inch		 9.439	 12454-05
<ol style="list-style-type: none"> 1.  Isacord 40 4752 		<ol style="list-style-type: none"> 1. Isacord 40 0015 2.  Isacord 40 2650 3.  Isacord 40 2155 4. Isacord 40 0015 			
 12454-06		 117 x 48 mm 4.6 x 1.9 inch		 11.296	 12454-07
<ol style="list-style-type: none"> 1.  Isacord 40 0250 2.  Isacord 40 2508 3. Isacord 40 0015 4.  Isacord 40 2650 5.  Isacord 40 2155 6. Isacord 40 0015 7.  Isacord 40 2650 		<ol style="list-style-type: none"> 1. Isacord 40 0015 2.  Isacord 40 2650 3.  Isacord 40 2508 4.  Isacord 40 2155 5.  Isacord 40 2650 			
Fa981		 35 x 142 mm 1.4 x 5.6 inch		 3.709	Be790701
<ol style="list-style-type: none"> 1.  Isacord 40 1055 		<ol style="list-style-type: none"> 1.  Isacord 40 2300 			
Be790704		 72 x 218 mm 2.9 x 8.6 inch		 3.638	Be790703
<ol style="list-style-type: none"> 1.  Isacord 40 0501 2.  Isacord 40 5633 3.  Isacord 40 0020 		<ol style="list-style-type: none"> 1.  Isacord 40 1306 			

<p>Be790702  73 x 190 mm 2.9 x 7.5 inch  9.135</p>	<p>21013-29  40 x 152 mm 1.6 x 6 inch  7.569</p>
<p>1.  Isacord 40 0442</p> 	<p>1.  Isacord 40 4332</p> 
<p>21013-30  76 x 76 mm 3 x 3 inch  5.519</p>	<p> 12398-29  26 x 153 mm 1 x 6 inch  13.035</p>
<p>1.  Isacord 40 4332</p> 	<p>1.  Isacord 40 1351</p> 
<p> 12398-30  77 x 77 mm 3 x 3 inch  12.150</p>	<p> Oc33411  24 x 177 mm 0.9 x 7 inch  15.868</p>
<p>1.  Isacord 40 1351</p> 	<p>1. Isacord 40 0015</p> 
<p>Cm471_48  59 x 190 mm 2.3 x 7.5 inch  13.902</p>	<p>Fb403_48  52 x 208 mm 2.1 x 8.2 inch  3.077</p>
<p>1.  Isacord 40 0630 2.  Isacord 40 0932 3.  Isacord 40 3953 4.  Isacord 40 3730 5.  Isacord 40 3652 6.  Isacord 40 4174 7.  Isacord 40 0101</p> 	<p>1.  Isacord 40 1355 2.  Isacord 40 3953</p> 
<p>Fq785_48  92 x 342 mm 3.6 x 13.5 inch  11.130</p>	<p>Fq969_48  52 x 162 mm 2 x 6.4 inch  2.804</p>
<p>1.  Yenmet 7003 2.  Yenmet 7008 3.  Yenmet 7001</p> 	<p>1.  Isacord 40 0170 2.  Isacord 40 0873 3.  Isacord 40 1860</p> 
<p>Fq736_48  8 x 253 mm 0.3 x 10 inch  5.097</p>	<p>Bd582_48  48 x 171 mm 1.9 x 6.7 inch  4.177</p>
<p>1.  Isacord 40 1375 2.  Isacord 40 4111 3.  Isacord 40 3962</p> 	<p>1.  Isacord 40 0870</p> 

Overview Stitch Patterns

Na912_48  115 x 16 mm 4.5 x 0.6 inch  2.285	Na914_48  19 x 120 mm 0.7 x 4.7 inch  4.691
<ol style="list-style-type: none"> 1.  Isacord 40 4230 2.  Isacord 40 0853 	<ol style="list-style-type: none"> 1.  Isacord 40 3151 2.  Isacord 40 3251 3.  Isacord 40 3150 
Nb478_48  122 x 85 mm 4.8 x 3.4 inch  16.092	Fq945_48  94 x 95 mm 3.7 x 3.7 inch  8.798
<ol style="list-style-type: none"> 1.  Isacord 40 0870 2.  Isacord 40 0670 3.  Isacord 40 0870 4.  Isacord 40 0670 	<ol style="list-style-type: none"> 1.  Isacord 40 0672 2.  Isacord 40 0873 
 Fb422_48  52 x 34 mm 2.1 x 1.3 inch  4.665	 Fb423_48  133 x 54 mm 5.2 x 2.1 inch  15.013
<ol style="list-style-type: none"> 1.  Isacord 40 3151 	<ol style="list-style-type: none"> 1.  Isacord 40 3150 

Children

 Be790305  118 x 145 mm 4.6 x 5.7 inch  13.118	12535-03  160 x 120 mm 6.3 x 4.7 inch  7.380
<ol style="list-style-type: none"> 1. Isacord 40 0015 2.  Applique 1 3.  Applique 3 4.  Isacord 40 3541 5.  Applique 1 6.  Applique 3 7.  Isacord 40 0345 8.  Applique 1 9.  Applique 3 10.  Isacord 40 1900 11.  Isacord 40 0020 12. Isacord 40 0015 	<ol style="list-style-type: none"> 1.  Isacord 40 4610 2.  Isacord 40 4610 3.  Isacord 40 1430 4.  Isacord 40 1430 5.  Isacord 40 0131 6.  Isacord 40 0131 7.  Isacord 40 4610 8.  Isacord 40 2520 9.  Isacord 40 2520 
Be790302  68 x 66 mm 2.7 x 2.6 inch  6.242	Be790303  70 x 70 mm 2.7 x 2.8 inch  5.764
<ol style="list-style-type: none"> 1.  Isacord 40 1114 2.  Isacord 40 1730 3.  Isacord 40 2101 4.  Isacord 40 1114 5.  Isacord 40 0020 6. Isacord 40 0015 7.  Isacord 40 4116 8.  Isacord 40 1600 	<ol style="list-style-type: none"> 1.  Isacord 40 0532 2.  Isacord 40 1300 3.  Isacord 40 0020 4. Isacord 40 0015 

Be790304 127 x 66 mm 5 x 2.6 inch 6.593

1. Isacord 40 4033
2. Isacord 40 1061
3. Isacord 40 1900
4. Isacord 40 1114
5. Isacord 40 4952
6. Isacord 40 1753
7. Isacord 40 2912
8. Isacord 40 5730

Be790307 142 x 127 mm 5.6 x 5 inch 19.667

1. Applique 1
2. Applique 3
3. Isacord 40 3130
4. Applique 1
5. Applique 3
6. Isacord 40 0003
7. Isacord 40 1720
8. Isacord 40 0020
9. Isacord 40 0520
10. Isacord 40 3541

Be790308 155 x 178 mm 6.1 x 7 inch 25.448

1. Isacord 40 0020
2. Applique 1
3. Applique 2
4. Isacord 40 1720

12421-03 46 x 48 mm 1.8 x 1.9 inch 2.328

1. Isacord 40 0020
2. Isacord 40 0015
3. Isacord 40 0111

Nb193_48 113 x 96 mm 4.5 x 3.8 inch 8.079

1. Isacord 40 2363
2. Isacord 40 2650
3. Isacord 40 5912
4. Isacord 40 1600
5. Isacord 40 3920
6. Isacord 40 0821
7. Isacord 40 2830
8. Isacord 40 2153

Cm384 77 x 80 mm 3 x 3.2 inch 9.534

1. Isacord 40 3732
2. Isacord 40 3444
3. Isacord 40 3761
4. Isacord 40 3641
5. Isacord 40 5411
6. Isacord 40 3611
7. Isacord 40 0020

Cm226_48 63 x 63 mm 2.5 x 2.5 inch 6.214

1. Isacord 40 0101
2. Isacord 40 0131
3. Isacord 40 0152
4. Isacord 40 0020
5. Isacord 40 1755

Cm193 107 x 127 mm 4.2 x 5 inch 12.461





























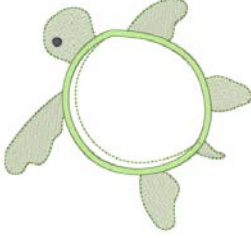

1. Isacord 40 2155
2. Isacord 40 2250
3. Isacord 40 2155
4. Isacord 40 2250
5. Isacord 40 2153
6. Isacord 40 3151
7. Isacord 40 2155
8. Isacord 40 0142
9. Isacord 40 2155
10. Isacord 40 2171

Cm220_48 71 x 72 mm 2.8 x 2.8 inch 7.571









1. Isacord 40 1755
2. Isacord 40 0101
3. Isacord 40 0142
4. Isacord 40 0101
5. Isacord 40 4071
6. Isacord 40 0142
7. Isacord 40 0934
8. Isacord 40 0020

Wp325 78 x 94 mm 3.1 x 3.7 inch 14.796

1. Isacord 40 0101
2. Isacord 40 1860
3. Isacord 40 0552
4. Isacord 40 0124
5. Isacord 40 0851
6. Isacord 40 0761
7. Isacord 40 0832
8. Isacord 40 0853
9. Isacord 40 0934
10. Isacord 40 0945
11. Isacord 40 1876
12. Isacord 40 0131
13. Isacord 40 0111
14. Isacord 40 0020



<p>Cm428_48  78 x 106 mm 3.1 x 4.2 inch  15.875</p> <ol style="list-style-type: none"> 1. Isacord 40 0832 2. Isacord 40 0660 3. Isacord 40 0651 4. Isacord 40 0853 5. Isacord 40 0933 6. Isacord 40 3045 7. Isacord 40 2764 8. Isacord 40 2832 9. Isacord 40 0020 10. Isacord 40 0651 11. Isacord 40 0015 	<p>Cm404_48  47 x 165 mm 1.9 x 6.5 inch  7.630</p> <ol style="list-style-type: none"> 1. Isacord 40 3710 2. Isacord 40 3730 3. Isacord 40 2250 4. Isacord 40 2320 
<p>Cm368  70 x 140 mm 2.8 x 5.5 inch  4.392</p> <ol style="list-style-type: none"> 1. Isacord 40 2550 2. Isacord 40 3971 3. Isacord 40 3130 4. Isacord 40 0713 5. Isacord 40 0131 	<p>Cm147  55 x 100 mm 2.2 x 3.9 inch  6.170</p> <ol style="list-style-type: none"> 1. Isacord 40 1755 2. Isacord 40 0713 3. Isacord 40 0704 4. Isacord 40 6141 5. Isacord 40 3251 6. Isacord 40 1600 
<p>Cm022  89 x 97 mm 3.5 x 3.8 inch  10.323</p> <ol style="list-style-type: none"> 1. Isacord 40 0532 2. Isacord 40 5730 3. Isacord 40 1730 4. Isacord 40 0015 5. Isacord 40 1352 6. Isacord 40 2920 7. Isacord 40 5531 8. Isacord 40 3040 	<p>Cm442  46 x 47 mm 1.8 x 1.8 inch  4.720</p> <ol style="list-style-type: none"> 1. Isacord 40 0622 2. Isacord 40 1703 3. Isacord 40 1913 4. Isacord 40 3722 5. Isacord 40 3600 6. Isacord 40 0182 7. Isacord 40 0176 8. Isacord 40 0015 
<p>Cm362_48  120 x 113 mm 4.7 x 4.4 inch  6.792</p> <ol style="list-style-type: none"> 1. Isacord 40 6051 2. Isacord 40 5650 3. Isacord 40 6051 4. Isacord 40 5531 5. Isacord 40 4174 6. Isacord 40 5610 	<p>Wp201_48  76 x 92 mm 3 x 3.6 inch  12.651</p> <ol style="list-style-type: none"> 1. Isacord 40 2166 2. Isacord 40 6141 3. Isacord 40 0101 4. Isacord 40 0651 5. Isacord 40 0142 6. Isacord 40 0131 7. Isacord 40 4174 8. Isacord 40 3761 9. Isacord 40 3641 10. Isacord 40 3710 11. Isacord 40 0832 
<p>Cm286_48  98 x 82 mm 3.9 x 3.2 inch  10.564</p> <ol style="list-style-type: none"> 1. Isacord 40 0015 2. Isacord 40 3650 3. Isacord 40 0142 4. Isacord 40 2363 5. Isacord 40 0020 6. Isacord 40 5531 7. Isacord 40 2550 	<p>Ck970  85 x 82 mm 3.3 x 3.2 inch  16.571</p> <ol style="list-style-type: none"> 1. Isacord 40 0151 2. Isacord 40 0152 3. Isacord 40 0124 4. Isacord 40 0131 5. Isacord 40 3150 6. Isacord 40 2830 7. Isacord 40 3040 8. Isacord 40 3640 9. Isacord 40 3710 10. Isacord 40 2051 11. Isacord 40 1725 12. Isacord 40 3743 13. Isacord 40 0015 14. Isacord 40 3743 





Rc765  100 x 99 mm
3.9 x 3.9 inch  11.289

1.  Isacord 40 0853
2.  Isacord 40 1913
3.  Isacord 40 0015
4.  Isacord 40 3750
5.  Isacord 40 0131
6.  Isacord 40 1565
7.  Isacord 40 0824
8.  Isacord 40 1800
9.  Isacord 40 4230



















Flowers

80001-23  85 x 102 mm
3.4 x 4 inch  4.257



1.  Isacord 40 1102
2.  Isacord 40 1805
3.  Isacord 40 6011
4.  Isacord 40 4174











82006-02  128 x 205 mm
5.1 x 8.1 inch  34.459

1.  Isacord 40 4174
2.  Isacord 40 0108
3.  Isacord 40 0771
4.  Isacord 40 4421
5.  Isacord 40 0643
6.  Isacord 40 0660
7.  Isacord 40 0660
8.  Isacord 40 0660
9.  Isacord 40 0832
10.  Isacord 40 0643
11.  Isacord 40 4421
12.  Isacord 40 1526
13.  Isacord 40 4421
14.  Isacord 40 0660
15.  Isacord 40 4174











Be790404  202 x 226 mm
7.9 x 8.9 inch  41.537

1.  Isacord 40 5912
2.  Isacord 40 6031
3.  Isacord 40 2155
4.  Isacord 40 2500
5.  Isacord 40 3241
6.  Isacord 40 3211
7.  Isacord 40 6031
8.  Isacord 40 5912







12392-01  112 x 157 mm
4.4 x 6.2 inch  7.321



1.  Isacord 40 1030
2.  Applique 1
3.  Applique 3
4.  Isacord 40 1102
5.  Isacord 40 4240
6.  Isacord 40 4220
7.  Applique 1
8.  Applique 3
9.  Applique 1











12392-13  112 x 203 mm
4.4 x 8 inch  5.418

1.  Isacord 40 4240
2.  Isacord 40 4220
3.  Isacord 40 1030
4.  Isacord 40 1102











12457-13  113 x 130 mm
4.4 x 5.1 inch  6.676

1.  Isacord 40 6051
2.  Isacord 40 5730
3.  Isacord 40 5722
4.  Isacord 40 2905
5.  Isacord 40 0311
6.  Isacord 40 5115
7.  Isacord 40 5220
8.  Isacord 40 5100



12457-06  106 x 172 mm
4.2 x 6.8 inch  12.636

































































































1.  Isacord 40 3150
2.  Isacord 40 3210
3.  Isacord 40 0311
4.  Isacord 40 3331
5.  Isacord 40 3711
6.  Isacord 40 2250
7.  Isacord 40 2241
8.  Isacord 40 2051



Be790401  206 x 242 mm
8.1 x 9.5 inch  11.593

1.  Isacord 40 1900



Be790405  126 x 185 mm 4.9 x 7.3 inch  7.734	Fs142_48  69 x 144 mm 2.7 x 5.7 inch  8.554
1.  Isacord 40 3102 	1.  Isacord 40 3711 2.  Isacord 40 0020 
82004-34  199 x 281 mm 7.8 x 11.1 inch  37.787	Be790409  188 x 215 mm 7.4 x 8.5 inch  37.708
1.  Isacord 40 5722 2.  Applique 1 3.  Isacord 40 5050 4.  Isacord 40 0015 5.  Applique 1 6.  Isacord 40 1220 7.  Applique 1 8.  Isacord 40 1900 9.  Isacord 40 0506 10.  Applique 1 11.  Isacord 40 0640 12.  Isacord 40 1730 13.  Isacord 40 0015 14.  Applique 1 15.  Isacord 40 5050 16.  Isacord 40 4111 17.  Isacord 40 0015 18.  Isacord 40 4111 19.  Isacord 40 5610 	1.  Isacord 40 0142 2.  Isacord 40 0822 3.  Isacord 40 0345 4.  Isacord 40 4122 5.  Isacord 40 3554 6.  Isacord 40 1300 
Be790402  146 x 280 mm 5.8 x 11 inch  11.199	Fq061  75 x 93 mm 3 x 3.6 inch  12.122
1.  Isacord 40 0933 	1.  Isacord 40 1344 2.  Isacord 40 0250 3.  Isacord 40 0352 4.  Isacord 40 5833 5.  Isacord 40 3640 6.  Isacord 40 3641 7.  Isacord 40 1344 8.  Isacord 40 5643 
Fq801  46 x 112 mm 1.8 x 4.4 inch  8.687	Fq273  88 x 193 mm 3.5 x 7.6 inch  5.100
1.  Isacord 40 5633 2.  Isacord 40 5730 3.  Isacord 40 1154 4.  Isacord 40 2011 5.  Isacord 40 1921 6.  Isacord 40 1753 7.  Isacord 40 2530 8.  Isacord 40 2560 9.  Isacord 40 2363 	1.  Isacord 40 0465 2.  Isacord 40 0853 3.  Isacord 40 2550 4.  Isacord 40 0933 
Fq055  84 x 100 mm 3.3 x 3.9 inch  16.145	Fq982_48  150 x 218 mm 5.9 x 8.6 inch  30.949
1.  Isacord 40 0546 2.  Isacord 40 0232 3.  Isacord 40 0520 4.  Isacord 40 0250 5.  Isacord 40 5833 6.  Isacord 40 6141 7.  Isacord 40 0941 8.  Isacord 40 5933 	1.  Isacord 40 1860 2.  Isacord 40 0771 3.  Isacord 40 0873 4.  Isacord 40 0170 5.  Isacord 40 0870 6.  Isacord 40 2051 7.  Isacord 40 0862 8.  Isacord 40 2152 

Fb268 124 x 87 mm
4.9 x 3.4 inch 7.569

1. Isacord 40 3211
2. Isacord 40 1755
3. Isacord 40 3241
4. Isacord 40 0700
5. Isacord 40 0904
6. Isacord 40 2160
7. Isacord 40 1725
8. Isacord 40 0504
9. Isacord 40 5933
10. Isacord 40 5610
11. Isacord 40 5933
12. Isacord 40 1725

Fq934_48 119 x 192 mm
4.7 x 7.6 inch 26.468

1. Isacord 40 0873
2. Isacord 40 0776
3. Isacord 40 0020
4. Isacord 40 5650
5. Isacord 40 5531
6. Isacord 40 5513
7. Isacord 40 3130
8. Isacord 40 2920
9. Isacord 40 3350
10. Isacord 40 3210
11. Isacord 40 0015
12. Isacord 40 0230
13. Isacord 40 3541
14. Isacord 40 0873
15. Isacord 40 0776

Cm418 46 x 87 mm
1.8 x 3.4 inch 3.578

1. Isacord 40 5822
2. Isacord 40 5833
3. Isacord 40 2155
4. Isacord 40 3045
5. Isacord 40 3130
6. Isacord 40 3211
7. Isacord 40 0520
8. Isacord 40 0703

Fq972_48 111 x 73 mm
4.4 x 2.9 inch 8.487

1. Isacord 40 0873
2. Isacord 40 1860
3. Isacord 40 0170

Fq548_48 94 x 159 mm
3.7 x 6.3 inch 4.879

1. Isacord 40 2241
2. Isacord 40 1860
3. Isacord 40 2152
4. Isacord 40 0552
5. Isacord 40 6051
6. Isacord 40 5833
7. Isacord 40 5934
8. Isacord 40 0970

Nb513 104 x 112 mm
4.1 x 4.4 inch 5.912

1. Isacord 40 0131
2. Isacord 40 4174

Fq274 63 x 78 mm
2.5 x 3.1 inch 2.848

1. Isacord 40 0232
2. Isacord 40 0465
3. Isacord 40 2550
4. Isacord 40 0853
5. Isacord 40 0933

Nb668 114 x 165 mm
4.5 x 6.5 inch 4.600











1. Isacord 40 0020
2. Isacord 40 0824
3. Isacord 40 0542





Fq331 85 x 64 mm
3.3 x 2.5 inch 5.007

1. Isacord 40 1172
2. Isacord 40 6141
3. Isacord 40 5552
4. Isacord 40 3962
5. Isacord 40 4113

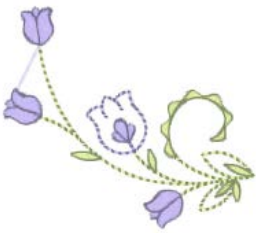













Fq738_48 51 x 101 mm
2 x 4 inch 3.777















1. Isacord 40 3962
2. Isacord 40 0670
3. Isacord 40 5822
4. Isacord 40 1375













Fq434	 100 x 162 mm 3.9 x 6.4 inch	 17.087	Fb419_48	 64 x 56 mm 2.5 x 2.2 inch	 1.829
<ol style="list-style-type: none">  Isacord 40 5050  Isacord 40 5833  Isacord 40 5610 			<ol style="list-style-type: none">  Isacord 40 6141  Isacord 40 3151 		





































































Ws673	 68 x 170 mm 2.7 x 6.7 inch	 4.465
<ol style="list-style-type: none">  Isacord 40 0842  Isacord 40 1565 		

Seasons







12384-02	 133 x 203 mm 5.2 x 8 inch	 25.217	12384-11	 84 x 190 mm 3.3 x 7.5 inch	 12.632
<ol style="list-style-type: none">  Isacord 40 0945  Isacord 40 4220  Isacord 40 4531  Isacord 40 4752  Isacord 40 0352  Isacord 40 0454 			<ol style="list-style-type: none">  Isacord 40 6151  Isacord 40 0352 		

12443-03	 120 x 161 mm 4.7 x 6.4 inch	 18.124	12443-11	 73 x 193 mm 2.9 x 7.6 inch	 11.300
<ol style="list-style-type: none">  Isacord 40 0111  Isacord 40 0182  Isacord 40 3630  Isacord 40 3722  Isacord 40 0182  Isacord 40 3630  Isacord 40 3722 			<ol style="list-style-type: none">  Isacord 40 0176  Isacord 40 3820 		

12427-01	 134 x 167 mm 5.3 x 6.6 inch	 25.591	12427-11	 82 x 126 mm 3.2 x 5 inch	 8.886
<ol style="list-style-type: none">  Isacord 40 1055  Isacord 40 1010  Isacord 40 1335  Isacord 40 1514  Isacord 40 1362 			<ol style="list-style-type: none">  Isacord 40 0660  Isacord 40 0532 		

<p>12400-03  123 x 161 mm 4.9 x 6.3 inch  19.286</p>	<p>12400-11  74 x 212 mm 2.9 x 8.3 inch  12.372</p>
<p>1.  Isacord 40 0853 2.  Isacord 40 0250 3.  Isacord 40 0352 4.  Isacord 40 5833</p> 	<p>1.  Isacord 40 0250 2.  Isacord 40 4430</p> 
<p>Hg319_48  89 x 151 mm 3.5 x 6 inch  8.681</p>	<p>Hg301_48  124 x 122 mm 4.9 x 4.8 inch  3.836</p>
<p>1.  Isacord 40 5822</p> 	<p>1.  Isacord 40 2101</p> 
<p>Bd603_48  80 x 78 mm 3.2 x 3.1 inch  1.486</p>	<p>He919_48  89 x 69 mm 3.5 x 2.7 inch  5.245</p>
<p>1.  Isacord 40 3600</p> 	<p>1.  Isacord 40 3650 2.  Isacord 40 3840 3.  Isacord 40 3641</p> 
<p>Hg053_48  122 x 122 mm 4.8 x 4.8 inch  15.370</p>	<p>Nb317_48  87 x 87 mm 3.4 x 3.4 inch  2.064</p>
<p>1.  Isacord 40 5531 2.  Isacord 40 5643 3.  Isacord 40 1805</p> 	<p>1.  Isacord 40 0020 2.  Isacord 40 0600 3.  Isacord 40 0800 4.  Isacord 40 0020</p> 
<p>Nb769_48  128 x 125 mm 5.1 x 4.9 inch  6.631</p>	<p>Na146  63 x 69 mm 2.5 x 2.7 inch  7.867</p>
<p>1.  Isacord 40 0651</p> 	<p>1.  Isacord 40 1703 2.  Isacord 40 1906 3.  Isacord 40 2113 4.  Isacord 40 1430 5.  Isacord 40 2363 6.  Isacord 40 0453 7.  Isacord 40 1154</p> 
<p>Nb039_48  97 x 127 mm 3.8 x 5 inch  11.464</p>	<p>Fq749_48  78 x 95 mm 3.1 x 3.7 inch  5.765</p>
<p>1.  Isacord 40 1141 2.  Isacord 40 0941 3.  Isacord 40 5643</p> 	<p>1.  Isacord 40 1114 2.  Isacord 40 1335 3.  Isacord 40 5664</p> 









Hg460_48  92 x 98 mm
3.6 x 3.9 inch  7.166

1.  Isacord 40 3650
2.  Isacord 40 0015
3.  Isacord 40 1921
4.  Isacord 40 3840
5.  Isacord 40 3810
6.  Isacord 40 4071
7.  Isacord 40 3444









Embellishment

Be790501  199 x 276 mm
7.9 x 10.9 inch  122.446



1.  Isacord 40 0015
2.  Isacord 40 2910
3.  Isacord 40 0020
4.  Isacord 40 3730
5.  Isacord 40 3631
6.  Isacord 40 3730
7.  Isacord 40 0015
8.  Isacord 40 2910
9.  Isacord 40 0020





Wp428_48  132 x 119 mm
5.2 x 4.7 inch  9.580



1.  Isacord 40 2920
2.  Isacord 40 4101
3.  Yenmet 7005
4.  Isacord 40 5210
5.  Isacord 40 5440





12576-05  190 x 229 mm
7.5 x 9 inch  39.218

1.  Isacord 40 1332
2.  Isacord 40 2022
3.  Isacord 40 3444



12473-04  94 x 184 mm
3.7 x 7.3 inch  11.531

1.  Isacord 40 5552
2.  Isacord 40 5374





12620-12  94 x 109 mm
3.7 x 4.3 inch  9.673

1.  Isacord 40 4114













21008-15  119 x 120 mm
4.7 x 4.7 inch  14.999

1.  Isacord 40 0504
2.  Isacord 40 0542
3.  Isacord 40 0132



82006-30   100 x 174 mm
3.9 x 6.9 inch  21.584

1.  Isacord 40 0020
2.  Isacord 40 4174
3.  Isacord 40 0020
4.  Isacord 40 4174
5.  Isacord 40 0771
6.  Isacord 40 0832
7.  Isacord 40 0108
8.  Isacord 40 4174
9.  Isacord 40 0660
10.  Isacord 40 1526



Be790503  130 x 131 mm
5.1 x 5.1 inch  8.816



1.  Isacord 40 3541





Be790504  121 x 121 mm
4.8 x 4.8 inch  4.900

- 1.  Isacord 40 3611















Fb126  87 x 102 mm
3.4 x 4 inch  2.668



- 1.  Isacord 40 1220
- 2.  Isacord 40 1805





 **82005-01**  176 x 109 mm
6.9 x 4.3 inch  13.171

- 1.  Applique 1
- 2.  Applique 3
- 3.  Isacord 40 2830
- 4.  Isacord 40 0851
- 5.  Isacord 40 0870
- 6.  Isacord 40 5822
- 7.  Isacord 40 1753
- 8.  Isacord 40 2711
- 9.  Isacord 40 0851
- 10.  Applique 1
- 11.  Applique 3
- 12.  Isacord 40 2711
- 13.  Isacord 40 0851











 **21003-26**  123 x 124 mm
4.8 x 4.9 inch  16.269



- 1.  Isacord 40 0345
- 2.  Isacord 40 0442
- 3.  Isacord 40 0232





 **82006-36**  122 x 123 mm
4.8 x 4.8 inch  21.745



- 1.  Applique 1
- 2.  Applique 3
- 3.  Isacord 40 4421
- 4.  Isacord 40 0660
- 5.  Isacord 40 0832
- 6.  Isacord 40 4174
- 7.  Isacord 40 0108
- 8.  Isacord 40 4421







Be790403  140 x 130 mm
5.5 x 5.1 inch  13.281



- 1.  Isacord 40 0020
- 2.  Isacord 40 0731





Nb018_48  90 x 97 mm
3.6 x 3.8 inch  11.158

- 1.  Isacord 40 0945
- 2.  Isacord 40 1252
- 3.  Isacord 40 1161
- 4.  Isacord 40 4010
- 5.  Isacord 40 4122





Nb728_48  97 x 112 mm
3.8 x 4.4 inch  4.836

- 1.  Isacord 40 6051
- 2.  Isacord 40 2560



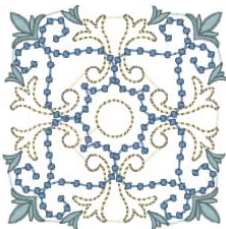

Nb403_48  78 x 78 mm
3.1 x 3.1 inch  6.615

- 1.  Isacord 40 0552
- 2.  Isacord 40 4032
- 3.  Isacord 40 4332

















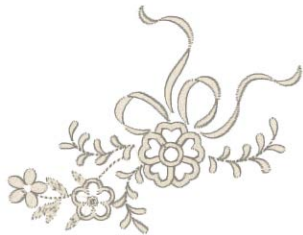

























































Hg079_48  116 x 116 mm
4.6 x 4.6 inch  5.671

- 1.  Isacord 40 5933
- 2.  Isacord 40 1913



Overview Stitch Patterns

Fb457_48  108 x 83 mm 4.2 x 3.3 inch  4.601	Fq881_48  129 x 129 mm 5.1 x 5.1 inch  7.877
1.  Isacord 40 0020 2.  Isacord 40 1172 	1.  Isacord 40 1061 2.  Isacord 40 0934 3.  Isacord 40 1172 4.  Isacord 40 5933 5.  Isacord 40 5610 6.  Isacord 40 2160 
Fb336_48  122 x 122 mm 4.8 x 4.8 inch  13.642	Fb377_48  121 x 92 mm 4.8 x 3.6 inch  6.220
1.  Isacord 40 0672 2.  Isacord 40 0776 3.  Isacord 40 2160 	1.  Isacord 40 4101 2.  Isacord 40 5613 3.  Isacord 40 4032 4.  Isacord 40 5613 
Fq870_48  122 x 105 mm 4.8 x 4.1 inch  7.485	Fb385_48  131 x 128 mm 5.1 x 5 inch  14.617
1.  Isacord 40 1061 2.  Isacord 40 0934 3.  Isacord 40 1172 4.  Isacord 40 1902 5.  Isacord 40 0506 6.  Isacord 40 0811 	1.  Isacord 40 3953 2.  Isacord 40 1355 3.  Isacord 40 5934 4.  Isacord 40 1355 5.  Isacord 40 3953 
Fq072_48  80 x 102 mm 3.1 x 4 inch  8.114	Nb101_48  99 x 99 mm 3.9 x 3.9 inch  10.455
1.  Isacord 40 1430 	1.  Isacord 40 1311 
Nb373_48  121 x 177 mm 4.8 x 7 inch  9.769	Ws649_48  125 x 248 mm 4.9 x 9.8 inch  22.270
1.  Isacord 40 4531 	1.  Isacord 40 3962 2.  Isacord 40 3910 3.  Isacord 40 3901 
Nb708_48  138 x 128 mm 5.4 x 5 inch  3.677	Fb433_48  121 x 121 mm 4.8 x 4.8 inch  16.809
1.  Isacord 40 0111 2.  Isacord 40 4174 	1.  Isacord 40 3130 2.  Isacord 40 3150 3.  Isacord 40 4240 

Sport and Hobbies

<p>Be790601  80 x 80 mm 3.2 x 3.1 inch  12.560</p>	<p>Be790602  80 x 75 mm 3.1 x 3 inch  10.169</p>
<p>1.  Isacord 40 4133 2.  Isacord 40 0800</p> 	<p>1.  Isacord 40 5643 2.  Isacord 40 5912 3.  Isacord 40 0015</p> 
<p> 12611-08  80 x 120 mm 3.1 x 4.7 inch  5.770</p>	<p> 12611-18  130 x 158 mm 5.1 x 6.2 inch  8.045</p>
<p>1.  Applique 1 2.  Applique 2 3.  Applique 1 4.  Applique 2 5.  Isacord 40 1154 6.  Isacord 40 5440 7.  Isacord 40 1902</p> 	<p>1.  Applique 1 2.  Applique 2 3.  Isacord 40 0151 4.  Isacord 40 5440</p> 
<p>Be790603  80 x 75 mm 3.2 x 2.9 inch  11.824</p>	<p>Be790604  80 x 80 mm 3.1 x 3.2 inch  20.838</p>
<p>1.  Isacord 40 0015 2.  Isacord 40 3654</p> 	<p>1.  Isacord 40 0660 2.  Isacord 40 1233 3.  Isacord 40 0660</p> 
<p>Be790605  80 x 80 mm 3.1 x 3.1 inch  14.136</p>	<p>Be790606  100 x 86 mm 3.9 x 3.4 inch  7.445</p>
<p>1.  Isacord 40 0015 2.  Isacord 40 3363 3.  Isacord 40 4116 4.  Isacord 40 0020</p> 	<p>1.  Isacord 40 0020 2.  Isacord 40 1306</p> 
<p>Be790607  80 x 74 mm 3.1 x 2.9 inch  6.046</p>	<p>Be790608  80 x 80 mm 3.2 x 3.1 inch  7.937</p>
<p>1.  Isacord 40 1115</p> 	<p>1.  Isacord 40 0020</p> 

Sp980  63 x 64 mm
2.5 x 2.5 inch  11.286

1. Isacord 40 0015
2. Isacord 40 0142
3. Isacord 40 0020



Nb036  36 x 70 mm
1.4 x 2.8 inch  3.909

1. Isacord 40 3770
2. Isacord 40 0131
3. Isacord 40 0622
4. Isacord 40 0015



Rc244  88 x 53 mm
3.5 x 2.1 inch  12.558

1. Isacord 40 0020
2. Isacord 40 3600
3. Isacord 40 4230
4. Yenmet 7005
5. Isacord 40 3910
6. Isacord 40 1902
7. Isacord 40 1912
8. Isacord 40 0108
9. Isacord 40 0020
10. Isacord 40 0015



11. Isacord 40 0124

Rc675  102 x 80 mm
4 x 3.1 inch  10.667

1. Isacord 40 0853
2. Isacord 40 4174
3. Isacord 40 0142
4. Isacord 40 1061
5. Isacord 40 1565
6. Isacord 40 0111
7. Isacord 40 3971
8. Isacord 40 1172
9. Isacord 40 0842
10. Isacord 40 0940
13. Isacord 40 0015
16. Isacord 40 0142



11. Isacord 40 0101
12. Isacord 40 3840
14. Isacord 40 3652
15. Isacord 40 4174

Sp266  76 x 54 mm
3 x 2.1 inch  3.690

1. Isacord 40 1902
2. Isacord 40 3600



Sp989  102 x 82 mm
4 x 3.2 inch  10.827

1. Isacord 40 4174
2. Isacord 40 0142
3. Isacord 40 3901
4. Isacord 40 3962
5. Isacord 40 0506
6. Isacord 40 0520
7. Isacord 40 0020

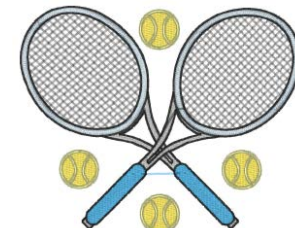

Sr067  87 x 97 mm
3.4 x 3.8 inch  16.143

1. Isacord 40 3910
2. Isacord 40 0706
3. Isacord 40 4531
4. Isacord 40 4430
5. Isacord 40 1106
6. Isacord 40 0501
7. Isacord 40 5500
8. Isacord 40 0020
9. Isacord 40 4010



Lt870  97 x 57 mm
3.8 x 2.2 inch  10.380

1. Isacord 40 3650
2. Isacord 40 0015
3. Isacord 40 0150
4. Isacord 40 1902
5. Isacord 40 0853
6. Isacord 40 1565
7. Isacord 40 0020
8. Isacord 40 0142
9. Isacord 40 2171



Sr589  95 x 66 mm
3.7 x 2.6 inch  14.868

1. Isacord 40 0142
2. Isacord 40 1220
3. Isacord 40 1332
4. Isacord 40 1334
5. Isacord 40 3611
6. Isacord 40 1800
7. Isacord 40 0015
8. Isacord 40 4174







































































































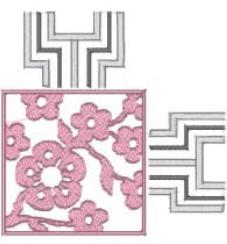











Fb158  39 x 53 mm
1.6 x 2.1 inch  2.889

1. Isacord 40 1123
2. Isacord 40 0861
3. Isacord 40 2363
4. Isacord 40 1755
5. Isacord 40 0131

















































Asia

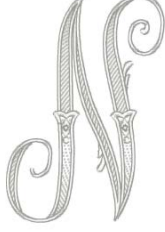







































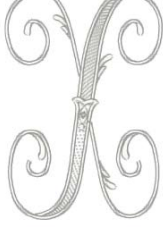





<p>Nb124_48  172 x 132 mm 6.8 x 5.2 inch  46.607</p>	<p>BE790801  129 x 131 mm 5.1 x 5.1 inch  11.306</p>
<p>1.  Isacord 40 0101 2.  Isacord 40 0640 3.  Isacord 40 6141 4.  Isacord 40 5833 5.  Isacord 40 0221 6.  Isacord 40 2022 7.  Isacord 40 1730 8.  Isacord 40 1114 9.  Isacord 40 2022</p> 	<p>1.  Isacord 40 0851</p> 
<p>BE790802  36 x 117 mm 1.4 x 4.6 inch  9.166</p>	<p>BE790803  36 x 350 mm 1.4 x 13.8 inch  17.193</p>
<p>1.  Isacord 40 0851</p> 	<p>1.  Isacord 40 0851</p> 
<p>Fq212_48  62 x 62 mm 2.4 x 2.4 inch  5.308</p>	<p>Fb492_48  87 x 293 mm 3.4 x 11.5 inch  28.865</p>
<p>1.  Isacord 40 0941 2.  Isacord 40 0940 3.  Isacord 40 1725 4.  Isacord 40 1913 5.  Yenmet 7011</p> 	<p>1.  Isacord 40 0132 2.  Isacord 40 0015 3.  Isacord 40 2250 4.  Isacord 40 2363 5.  Isacord 40 2560 6.  Isacord 40 2155 7.  Isacord 40 2153 8.  Isacord 40 0713 9.  Isacord 40 0142 10.  Isacord 40 0643 11.  Isacord 40 2152</p> 
<p>Fq194_48  120 x 118 mm 4.7 x 4.7 inch  21.749</p>	<p>Fq217_48  85 x 59 mm 3.3 x 2.3 inch  7.250</p>
<p>1.  Isacord 40 1600 2.  Isacord 40 0940 3.  Isacord 40 0622 4.  Isacord 40 0941 5.  Isacord 40 1725 6.  Isacord 40 1913 7.  Yenmet 7011</p> 	<p>1.  Isacord 40 0941 2.  Isacord 40 0622 3.  Isacord 40 1725 4.  Isacord 40 1913 5.  Yenmet 7011 6.  Isacord 40 1600</p> 
<p>Fa427  112 x 66 mm 4.4 x 2.6 inch  13.208</p>	<p>Fb276_48  125 x 112 mm 4.9 x 4.4 inch  5.521</p>
<p>1.  Isacord 40 1134 2.  Isacord 40 0670 3.  Isacord 40 0861 4.  Isacord 40 0873 5.  Isacord 40 1134 6.  Isacord 40 1355 7.  Isacord 40 1800</p> 	<p>1.  Isacord 40 3622 2.  Isacord 40 3652</p> 

Fb283_48  102 x 109 mm 4 x 4.3 inch  3.721	Fb490_48  68 x 68 mm 2.7 x 2.7 inch  8.023
<ol style="list-style-type: none"> 1.  Isacord 40 3622 2.  Isacord 40 3711 	<ol style="list-style-type: none"> 1.  Isacord 40 2152 2.  Isacord 40 0142 3.  Isacord 40 0112 
Fb491_48  32 x 166 mm 1.2 x 6.5 inch  10.632	Nb491_48  79 x 168 mm 3.1 x 6.6 inch  5.286
<ol style="list-style-type: none"> 1.  Isacord 40 2152 2.  Isacord 40 0142 3.  Isacord 40 0112 	<ol style="list-style-type: none"> 1.  Isacord 40 1900 
Fb484_48  67 x 59 mm 2.6 x 2.3 inch  3.836	Wp423_48  90 x 158 mm 3.6 x 6.2 inch  12.132
<ol style="list-style-type: none"> 1.  Isacord 40 0643 	<ol style="list-style-type: none"> 1.  Isacord 40 0131 2.  Isacord 40 0020 3.  Isacord 40 1102 4.  Isacord 40 1301 

Charming monograms

12587-01  59 x 90 mm 2.3 x 3.5 inch  6.471	12587-02  52 x 90 mm 2.1 x 3.5 inch  6.938
<ol style="list-style-type: none"> 1.  Isacord 40 0101 	<ol style="list-style-type: none"> 1.  Isacord 40 0101 
12587-03  45 x 90 mm 1.8 x 3.5 inch  4.591	12587-04  57 x 90 mm 2.2 x 3.6 inch  6.580
<ol style="list-style-type: none"> 1.  Isacord 40 0101 	<ol style="list-style-type: none"> 1.  Isacord 40 0101 

<p>12587-05  50 x 90 mm 2 x 3.6 inch  5.643</p>	<p>12587-06  57 x 90 mm 2.2 x 3.5 inch  5.439</p>
<p>1.  Isacord 40 0101</p> 	<p>1.  Isacord 40 0101</p> 
<p>12587-07  39 x 90 mm 1.5 x 3.6 inch  5.200</p>	<p>12587-08  62 x 90 mm 2.4 x 3.6 inch  7.850</p>
<p>1.  Isacord 40 0101</p> 	<p>1.  Isacord 40 0101</p> 
<p>12587-09  49 x 89 mm 1.9 x 3.5 inch  4.990</p>	<p>12587-10  57 x 89 mm 2.2 x 3.5 inch  6.021</p>
<p>1.  Isacord 40 0101</p> 	<p>1.  Isacord 40 0101</p> 
<p>12587-11  62 x 91 mm 2.4 x 3.6 inch  7.067</p>	<p>12587-12  63 x 90 mm 2.5 x 3.5 inch  5.116</p>
<p>1.  Isacord 40 0101</p> 	<p>1.  Isacord 40 0101</p> 
<p>12587-13  64 x 92 mm 2.5 x 3.6 inch  7.776</p>	<p>12587-14  63 x 90 mm 2.5 x 3.6 inch  7.400</p>
<p>1.  Isacord 40 0101</p> 	<p>1.  Isacord 40 0101</p> 
<p>12587-15  44 x 90 mm 1.7 x 3.5 inch  5.783</p>	<p>12587-16  63 x 89 mm 2.5 x 3.5 inch  7.336</p>
<p>1.  Isacord 40 0101</p> 	<p>1.  Isacord 40 0101</p> 

<p>12587-17  54 x 89 mm 2.1 x 3.5 inch  6.583</p>	<p>12587-18  64 x 90 mm 2.5 x 3.6 inch  7.491</p>
<p>1.  Isacord 40 0101</p> 	<p>1.  Isacord 40 0101</p> 
<p>12587-19  56 x 90 mm 2.2 x 3.6 inch  5.705</p>	<p>12587-20  57 x 90 mm 2.2 x 3.6 inch  5.318</p>
<p>1.  Isacord 40 0101</p> 	<p>1.  Isacord 40 0101</p> 
<p>12587-21  62 x 91 mm 2.4 x 3.6 inch  6.137</p>	<p>12587-22  64 x 91 mm 2.5 x 3.6 inch  5.277</p>
<p>1.  Isacord 40 0101</p> 	<p>1.  Isacord 40 0101</p> 
<p>12587-23  64 x 90 mm 2.5 x 3.6 inch  7.519</p>	<p>12587-24  62 x 91 mm 2.4 x 3.6 inch  5.684</p>
<p>1.  Isacord 40 0101</p> 	<p>1.  Isacord 40 0101</p> 
<p>12587-25  52 x 91 mm 2 x 3.6 inch  5.979</p>	<p>12587-26  68 x 89 mm 2.7 x 3.5 inch  5.047</p>
<p>1.  Isacord 40 0101</p> 	<p>1.  Isacord 40 0101</p> 
<p>12587-53  67 x 23 mm 2.6 x 0.9 inch  994</p>	<p>12587-54  50 x 107 mm 2 x 4.2 inch  3.910</p>
<p>1.  Isacord 40 0101</p> 	<p>1.  Isacord 40 0101</p> 

12587-55	70 x 144 mm 2.8 x 5.7 inch	7.108	12587-56	49 x 100 mm 1.9 x 3.9 inch	3.819
-----------------	-------------------------------	-------	-----------------	-------------------------------	-------

1. Isacord 40 0101



1. Isacord 40 0101



12587-57	57 x 20 mm 2.3 x 0.8 inch	1.459	12587-58	53 x 116 mm 2.1 x 4.6 inch	3.614
-----------------	------------------------------	-------	-----------------	-------------------------------	-------

1. Isacord 40 0101



1. Isacord 40 0101



12587-59	33 x 94 mm 1.3 x 3.7 inch	2.321	12587-60	126 x 126 mm 5 x 5 inch	5.003
-----------------	------------------------------	-------	-----------------	----------------------------	-------

1. Isacord 40 0101



1. Isacord 40 0101



12587-61	36 x 29 mm 1.4 x 1.1 inch	2.091	12587-62	35 x 34 mm 1.4 x 1.3 inch	2.284
-----------------	------------------------------	-------	-----------------	------------------------------	-------

1. Isacord 40 0101



1. Isacord 40 0101



Animals

Cm140_48	88 x 98 mm 3.5 x 3.8 inch	14.589	Cm142	56 x 66 mm 2.2 x 2.6 inch	4.588
-----------------	------------------------------	--------	--------------	------------------------------	-------

1. Isacord 40 6051
2. Isacord 40 0453
3. Isacord 40 5552
4. Isacord 40 5822
5. Isacord 40 0015
6. Isacord 40 1902
7. Isacord 40 1521
8. Isacord 40 2022
9. Isacord 40 2123
10. Isacord 40 4174







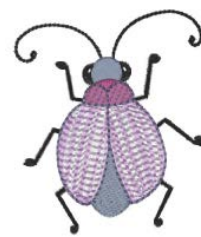





11. Isacord 40 0108

1. Isacord 40 0015
2. Isacord 40 0020
3. Isacord 40 3953
4. Isacord 40 2500
5. Isacord 40 3040
6. Isacord 40 0180
7. Isacord 40 2830
8. Isacord 40 3211







Overview Stitch Patterns

Fb258_48  83 x 184 mm
3.3 x 7.2 inch  14.817



1.  Isacord 40 5722
2.  Isacord 40 0532
3.  Isacord 40 0853
4.  Isacord 40 3951
5.  Isacord 40 6051
6.  Isacord 40 3762
7.  Isacord 40 0622
8.  Isacord 40 4174
9.  Isacord 40 3711

























Fq106  109 x 109 mm
4.3 x 4.3 inch  5.947



1.  Isacord 40 1911
2.  Isacord 40 1600
3.  Isacord 40 0822













Fq617  118 x 198 mm
4.6 x 7.8 inch  29.928



1.  Isacord 40 3640
2.  Isacord 40 0015
3.  Isacord 40 0970
4.  Isacord 40 0640
5.  Isacord 40 0520
6.  Isacord 40 0731
7.  Isacord 40 1332
8.  Isacord 40 1311
9.  Isacord 40 3962
10.  Isacord 40 3820
11.  Isacord 40 3710
12.  Isacord 40 3902
13.  Isacord 40 4174
14.  Isacord 40 2920
15.  Isacord 40 2155
16.  Isacord 40 0600
17.  Isacord 40 2171
18.  Isacord 40 2155
19.  Isacord 40 2530
20.  Isacord 40 0232
21.  Isacord 40 5531















Fq624  64 x 144 mm
2.5 x 5.7 inch  4.429



1.  Yenmet 7029
2.  Isacord 40 3820
3.  Isacord 40 2530
4.  Isacord 40 1102
5.  Isacord 40 4410
6.  Isacord 40 5610
7.  Isacord 40 5822
8.  Isacord 40 2152
9.  Isacord 40 0713















Mt022_48  123 x 125 mm
4.9 x 4.9 inch  35.446



1.  Isacord 40 2810
2.  Isacord 40 2715
3.  Isacord 40 2101
4.  Isacord 40 3906
5.  Isacord 40 0015
6.  Isacord 40 1102
7.  Isacord 40 3962
8.  Isacord 40 0506
9.  Isacord 40 5722
10.  Isacord 40 2550
11.  Isacord 40 5912
12.  Isacord 40 0660





Mt028  103 x 93 mm
4.1 x 3.7 inch  14.192



1.  Isacord 40 5722
2.  Isacord 40 0704
3.  Isacord 40 5912
4.  Isacord 40 3906
5.  Isacord 40 2550
6.  Isacord 40 2912
7.  Isacord 40 1703
8.  Isacord 40 0506
9.  Isacord 40 3962
10.  Isacord 40 2504
11.  Isacord 40 1102















Wm785  85 x 103 mm
3.3 x 4.1 inch  11.450

1.  Isacord 40 0020



Wp217  94 x 78 mm
3.7 x 3.1 inch  7.444

1.  Isacord 40 0101
2.  Isacord 40 4174
3.  Isacord 40 0020
4.  Isacord 40 0651
5.  Isacord 40 0152
6.  Isacord 40 0873
7.  Isacord 40 0861
8.  Isacord 40 0660
9.  Isacord 40 0934
10.  Isacord 40 5822
11.  Isacord 40 1725



Wp244 137 x 172 mm
5.4 x 6.8 inch 20.653

1. Isacord 40 0142
2. Isacord 40 0108
3. Isacord 40 0221
4. Isacord 40 0101
5. Isacord 40 1010
6. Isacord 40 0811
7. Isacord 40 1311
8. Isacord 40 4174
9. Isacord 40 0124
10. Isacord 40 0132
11. Isacord 40 0722
12. Isacord 40 0761
13. Isacord 40 5822
14. Isacord 40 5633
15. Isacord 40 0132



Ws610_48 127 x 111 mm
5 x 4.4 inch 4.658

1. Isacord 40 1874



DesignWorks

Dw11 70 x 71 mm
2.8 x 2.8 inch 110

1. Swarovski 0502

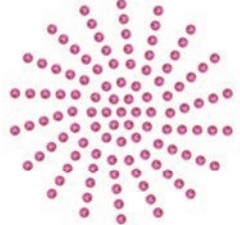

Be790901 182 x 252 mm
7.1 x 9.9 inch 38.392

1. Edding 34
2. Edding 9
3. Edding 33
4. Edding 68
5. Edding 1



Be790903 181 x 293 mm
7.1 x 11.5 inch 11.366

1. Edding 19



Be790905 104 x 227 mm
4.1 x 8.9 inch 21.349

1. Edding 34
2. Edding 12
3. Edding 16
4. Edding 10
5. Edding 1



Be790906 192 x 196 mm
7.6 x 7.7 inch 21.054

1. Edding 8
2. Edding 3
3. Edding 5
4. Edding 34
5. Edding 69
6. Edding 10
7. Edding 5
8. Edding 9
9. Edding 11
10. Edding 65
11. Edding 12



Be790909 167 x 322 mm
6.6 x 12.7 inch 20.162

1. Edding 7



Dw07 114 x 152 mm
4.5 x 6 inch 198

1. Swarovski 0237



Dw05 105 x 94 mm
4.1 x 3.7 inch 13.334

1. Isacord 40 2022
2. Cut 0001
3. Cut 0002
4. Cut 0003
5. Cut 0004
6. Isacord 40 2022



Dw10 119 x 119 mm 4.7 x 4.7 inch 5.939

1. Cut 0001
2. Cut 0002
3. Cut 0003
4. Cut 0004



Dw08 206 x 100 mm 8.1 x 3.9 inch 424

1. Swarovski 0501



Be700121 196 x 197 mm 7.7 x 7.8 inch 2.183

1. Isacord 40 3600
2. Isacord 40 1703



Be700122 119 x 37 mm 4.7 x 1.5 inch 4.124

1. Isacord 40 5833



Be700123 113 x 206 mm 4.4 x 8.1 inch 6.090

1. Punch 0004
2. Punch 0007



Be700124 141 x 134 mm 5.6 x 5.3 inch 6.184

1. Isacord 40 2300
2. Isacord 40 3901



Monograms in pink

Be790101 75 x 89 mm 2.9 x 3.5 inch 4.971

1. Isacord 40 2320
2. Isacord 40 4620
3. Isacord 40 2152
4. Isacord 40 0111
5. Isacord 40 0352
6. Isacord 40 2220
7. Isacord 40 1903



Be790102 73 x 89 mm 2.9 x 3.5 inch 5.741

1. Isacord 40 2320
2. Isacord 40 4620
3. Isacord 40 2152
4. Isacord 40 0111
5. Isacord 40 0352
6. Isacord 40 2220
7. Isacord 40 1903



Be790103 64 x 93 mm 2.5 x 3.6 inch 4.800

1. Isacord 40 2320
2. Isacord 40 4620
3. Isacord 40 2152
4. Isacord 40 0111
5. Isacord 40 0352
6. Isacord 40 2220
7. Isacord 40 1903



Be790104 90 x 98 mm 3.6 x 3.8 inch 5.856

1. Isacord 40 2320
2. Isacord 40 4620
3. Isacord 40 2152
4. Isacord 40 0111
5. Isacord 40 0352
6. Isacord 40 2220
7. Isacord 40 1903



Be790105 61 x 90 mm
2.4 x 3.5 inch 5.361

1. Isacord 40 2320
2. Isacord 40 4620
3. Isacord 40 2152
4. Isacord 40 0111
5. Isacord 40 0352
6. Isacord 40 2220
7. Isacord 40 1903

Be790106 64 x 90 mm
2.5 x 3.5 inch 4.953

1. Isacord 40 2320
2. Isacord 40 4620
3. Isacord 40 2152
4. Isacord 40 0111
5. Isacord 40 0352
6. Isacord 40 2220
7. Isacord 40 1903

Be790107 80 x 90 mm
3.1 x 3.5 inch 5.290

1. Isacord 40 2320
2. Isacord 40 4620
3. Isacord 40 2152
4. Isacord 40 0111
5. Isacord 40 0352
6. Isacord 40 2220
7. Isacord 40 1903

Be790108 71 x 90 mm
2.8 x 3.5 inch 5.936

1. Isacord 40 2320
2. Isacord 40 4620
3. Isacord 40 2152
4. Isacord 40 0111
5. Isacord 40 0352
6. Isacord 40 2220
7. Isacord 40 1903

Be790109 32 x 101 mm
1.3 x 4 inch 4.429

1. Isacord 40 2320
2. Isacord 40 4620
3. Isacord 40 2152
4. Isacord 40 0111
5. Isacord 40 0352
6. Isacord 40 2220
7. Isacord 40 1903

Be790110 73 x 89 mm
2.9 x 3.5 inch 4.782

1. Isacord 40 2320
2. Isacord 40 4620
3. Isacord 40 2152
4. Isacord 40 0111
5. Isacord 40 0352
6. Isacord 40 2220
7. Isacord 40 1903

Be790111 65 x 89 mm
2.6 x 3.5 inch 5.957

1. Isacord 40 2320
2. Isacord 40 4620
3. Isacord 40 2152
4. Isacord 40 0111
5. Isacord 40 0352
6. Isacord 40 2220
7. Isacord 40 1903

Be790112 70 x 90 mm
2.8 x 3.5 inch 4.725

1. Isacord 40 2320
2. Isacord 40 4620
3. Isacord 40 2152
4. Isacord 40 0111
5. Isacord 40 0352
6. Isacord 40 2220
7. Isacord 40 1903

Be790113 89 x 90 mm
3.5 x 3.6 inch 5.534

1. Isacord 40 2320
2. Isacord 40 4620
3. Isacord 40 2152
4. Isacord 40 0111
5. Isacord 40 0352
6. Isacord 40 2220
7. Isacord 40 1903

Be790114 76 x 91 mm
3 x 3.6 inch 6.341







1. Isacord 40 2320
2. Isacord 40 4620
3. Isacord 40 2152
4. Isacord 40 0111
5. Isacord 40 0352
6. Isacord 40 2220
7. Isacord 40 1903

Be790115 75 x 90 mm
2.9 x 3.5 inch 5.494



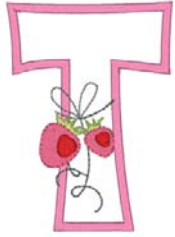
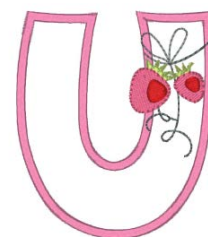

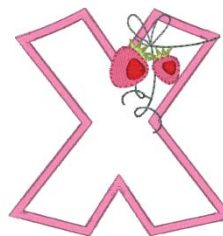
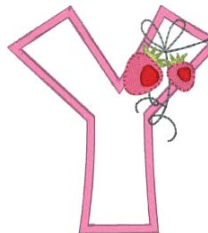







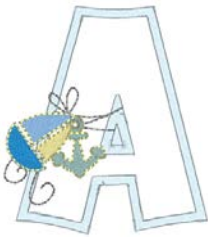











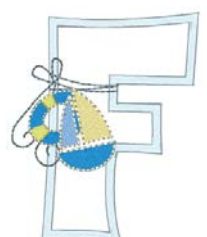

1. Isacord 40 2320
2. Isacord 40 4620
3. Isacord 40 2152
4. Isacord 40 0111
5. Isacord 40 0352
6. Isacord 40 2220
7. Isacord 40 1903

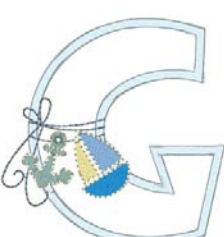
Be790116 71 x 103 mm
2.8 x 4.1 inch 5.408



1. Isacord 40 2320
2. Isacord 40 4620
3. Isacord 40 2152
4. Isacord 40 0111
5. Isacord 40 0352
6. Isacord 40 2220
7. Isacord 40 1903

<p>Be790117</p>	<p>82 x 101 mm 3.2 x 4 inch</p>	<p>6.212</p>	<p>1. Isacord 40 2320 2. Isacord 40 4620 3. Isacord 40 2152 4. Isacord 40 0111 5. Isacord 40 0352 6. Isacord 40 2220 7. Isacord 40 1903</p>		<p>Be790118</p>	<p>74 x 104 mm 2.9 x 4.1 inch</p>	<p>5.931</p>	<p>1. Isacord 40 2320 2. Isacord 40 4620 3. Isacord 40 2152 4. Isacord 40 0111 5. Isacord 40 0352 6. Isacord 40 2220 7. Isacord 40 1903</p>	
<p>Be790119</p>	<p>60 x 89 mm 2.4 x 3.5 inch</p>	<p>5.256</p>	<p>1. Isacord 40 2320 2. Isacord 40 4620 3. Isacord 40 2152 4. Isacord 40 0111 5. Isacord 40 0352 6. Isacord 40 2220 7. Isacord 40 1903</p>		<p>Be790120</p>	<p>72 x 100 mm 2.8 x 3.9 inch</p>	<p>5.327</p>	<p>1. Isacord 40 2320 2. Isacord 40 4620 3. Isacord 40 2152 4. Isacord 40 0111 5. Isacord 40 0352 6. Isacord 40 2220 7. Isacord 40 1903</p>	
<p>Be790121</p>	<p>78 x 90 mm 3.1 x 3.5 inch</p>	<p>5.588</p>	<p>1. Isacord 40 2320 2. Isacord 40 4620 3. Isacord 40 2152 4. Isacord 40 0111 5. Isacord 40 0352 6. Isacord 40 2220 7. Isacord 40 1903</p>		<p>Be790122</p>	<p>87 x 89 mm 3.4 x 3.5 inch</p>	<p>5.302</p>	<p>1. Isacord 40 2320 2. Isacord 40 4620 3. Isacord 40 2152 4. Isacord 40 0111 5. Isacord 40 0352 6. Isacord 40 2220 7. Isacord 40 1903</p>	
<p>Be790123</p>	<p>105 x 89 mm 4.1 x 3.5 inch</p>	<p>5.930</p>	<p>1. Isacord 40 2320 2. Isacord 40 4620 3. Isacord 40 2152 4. Isacord 40 0111 5. Isacord 40 0352 6. Isacord 40 2220 7. Isacord 40 1903</p>		<p>Be790124</p>	<p>91 x 92 mm 3.6 x 3.6 inch</p>	<p>5.721</p>	<p>1. Isacord 40 2320 2. Isacord 40 4620 3. Isacord 40 2152 4. Isacord 40 0111 5. Isacord 40 0352 6. Isacord 40 2220 7. Isacord 40 1903</p>	
<p>Be790125</p>	<p>84 x 89 mm 3.3 x 3.5 inch</p>	<p>4.866</p>	<p>1. Isacord 40 2320 2. Isacord 40 4620 3. Isacord 40 2152 4. Isacord 40 0111 5. Isacord 40 0352 6. Isacord 40 2220 7. Isacord 40 1903</p>		<p>Be790126</p>	<p>56 x 89 mm 2.2 x 3.5 inch</p>	<p>5.386</p>	<p>1. Isacord 40 2320 2. Isacord 40 4620 3. Isacord 40 2152 4. Isacord 40 0111 5. Isacord 40 0352 6. Isacord 40 2220 7. Isacord 40 1903</p>	

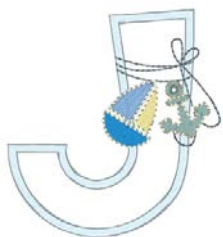
Monograms in blue



<p>Be790201  85 x 95 mm 3.3 x 3.8 inch  7.079</p> <ol style="list-style-type: none"> 1. Applique 1 2. Applique 2 3. Isacord 40 3963 4. Isacord 40 0111 5. Isacord 40 4752 6. Isacord 40 3900 7. Isacord 40 3630 8. Isacord 40 0232 9. Isacord 40 0630 	<p>Be790202  80 x 96 mm 3.1 x 3.8 inch  7.644</p> <ol style="list-style-type: none"> 1. Applique 1 2. Applique 2 3. Isacord 40 3963 4. Isacord 40 3852 5. Isacord 40 3900 6. Isacord 40 0221 7. Isacord 40 3900 8. Isacord 40 3630 9. Isacord 40 0232 10. Isacord 40 0640 
<p>Be790203  78 x 95 mm 3.1 x 3.8 inch  6.533</p> <ol style="list-style-type: none"> 1. Applique 1 2. Applique 2 3. Isacord 40 3963 4. Isacord 40 3852 5. Isacord 40 4752 6. Isacord 40 3900 7. Isacord 40 3630 8. Isacord 40 0232 9. Isacord 40 0630 	<p>Be790204  104 x 96 mm 4.1 x 3.8 inch  7.274</p> <ol style="list-style-type: none"> 1. Applique 1 2. Applique 2 3. Isacord 40 3963 4. Isacord 40 3852 5. Isacord 40 4752 6. Isacord 40 3900 7. Isacord 40 3630 8. Isacord 40 0232 9. Isacord 40 0660 
<p>Be790205  84 x 95 mm 3.3 x 3.8 inch  7.001</p> <ol style="list-style-type: none"> 1. Applique 1 2. Applique 2 3. Isacord 40 3963 4. Isacord 40 3852 5. Isacord 40 4752 6. Isacord 40 3900 7. Isacord 40 3630 8. Isacord 40 0232 9. Isacord 40 0660 	<p>Be790206  78 x 96 mm 3.1 x 3.8 inch  7.088</p> <ol style="list-style-type: none"> 1. Applique 1 2. Applique 2 3. Isacord 40 3963 4. Isacord 40 3852 5. Isacord 40 3900 6. Isacord 40 0221 7. Isacord 40 3900 8. Isacord 40 3630 9. Isacord 40 0232 10. Isacord 40 0640 
<p>Be790207  93 x 95 mm 3.6 x 3.8 inch  6.688</p> <ol style="list-style-type: none"> 1. Applique 1 2. Applique 2 3. Isacord 40 3963 4. Isacord 40 3852 5. Isacord 40 4752 6. Isacord 40 3900 7. Isacord 40 3630 8. Isacord 40 0232 9. Isacord 40 0660 	<p>Be790208  88 x 95 mm 3.4 x 3.8 inch  7.845</p> <ol style="list-style-type: none"> 1. Applique 1 2. Applique 2 3. Isacord 40 3963 4. Isacord 40 3852 5. Isacord 40 3900 6. Isacord 40 0221 7. Isacord 40 3900 8. Isacord 40 3630 9. Isacord 40 0232 10. Isacord 40 0640 
<p>Be790209  51 x 111 mm 2 x 4.4 inch  5.966</p> <ol style="list-style-type: none"> 1. Applique 1 2. Applique 2 3. Applique 1 4. Applique 2 5. Isacord 40 3963 6. Isacord 40 3852 7. Isacord 40 4752 8. Isacord 40 3900 9. Isacord 40 3630 10. Isacord 40 0232 11. Isacord 40 0660 	<p>Be790210  89 x 96 mm 3.5 x 3.8 inch  5.977</p> <ol style="list-style-type: none"> 1. Applique 1 2. Applique 2 3. Isacord 40 3963 4. Isacord 40 3852 5. Isacord 40 4752 6. Isacord 40 3900 7. Isacord 40 3630 8. Isacord 40 0232 9. Isacord 40 0660 

Overview Stitch Patterns

Be790211  75 x 95 mm
3 x 3.8 inch  6.908

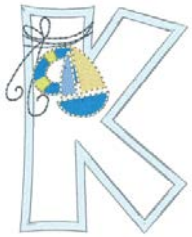

1. Applique 1
2. Applique 2
3. Isacord 40 3963
4. Isacord 40 3852
5. Isacord 40 3900
6. Isacord 40 0221
7. Isacord 40 3900
8. Isacord 40 3630
9. Isacord 40 0232
10. Isacord 40 0640



Be790212  83 x 95 mm
3.3 x 3.8 inch  6.145



1. Applique 1
2. Applique 2
3. Isacord 40 3963
4. Isacord 40 3852
5. Isacord 40 4752
6. Isacord 40 3900
7. Isacord 40 3630
8. Isacord 40 0232
9. Isacord 40 0660



Be790213  100 x 101 mm
3.9 x 4 inch  7.211



1. Applique 1
2. Applique 2
3. Isacord 40 3963
4. Isacord 40 3852
5. Isacord 40 4752
6. Isacord 40 3900
7. Isacord 40 3630
8. Isacord 40 0232
9. Isacord 40 0660



Be790214  90 x 95 mm
3.5 x 3.7 inch  8.224



1. Applique 1
2. Applique 2
3. Isacord 40 3963
4. Isacord 40 3852
5. Isacord 40 3900
6. Isacord 40 0221
7. Isacord 40 3900
8. Isacord 40 3630
9. Isacord 40 0232
10. Isacord 40 0640



Be790215  88 x 95 mm
3.5 x 3.8 inch  6.684

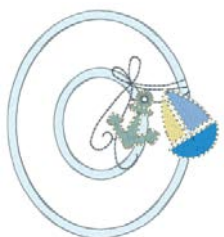

1. Applique 1
2. Applique 2
3. Isacord 40 3963
4. Isacord 40 3852
5. Isacord 40 4752
6. Isacord 40 3900
7. Isacord 40 3630
8. Isacord 40 0232
9. Isacord 40 0660



Be790216  72 x 95 mm
2.8 x 3.7 inch  5.906

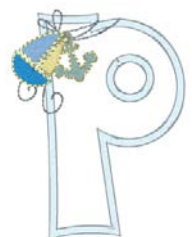

1. Applique 1
2. Applique 2
3. Isacord 40 3963
4. Isacord 40 3852
5. Isacord 40 4752
6. Isacord 40 3900
7. Isacord 40 3630
8. Isacord 40 0232
9. Isacord 40 0630



Be790217  86 x 102 mm
3.4 x 4 inch  7.327



1. Applique 1
2. Applique 2
3. Isacord 40 3963
4. Isacord 40 3852
5. Isacord 40 3900
6. Isacord 40 0221
7. Isacord 40 3900
8. Isacord 40 3630
9. Isacord 40 0232
10. Isacord 40 0640



Be790218  83 x 95 mm
3.3 x 3.7 inch  7.299



1. Applique 1
2. Applique 2
3. Isacord 40 3963
4. Isacord 40 3852
5. Isacord 40 4752
6. Isacord 40 3900
7. Isacord 40 3630
8. Isacord 40 0232
9. Isacord 40 0630



Be790219  79 x 95 mm
3.1 x 3.8 inch  6.541



1. Applique 1
2. Applique 2
3. Isacord 40 3963
4. Isacord 40 3852
5. Isacord 40 4752
6. Isacord 40 3900
7. Isacord 40 3630
8. Isacord 40 0232
9. Isacord 40 0660



Be790220  69 x 95 mm
2.7 x 3.8 inch  6.635



1. Applique 1
2. Applique 2
3. Isacord 40 3963
4. Isacord 40 3852
5. Isacord 40 3900
6. Isacord 40 0221
7. Isacord 40 3900
8. Isacord 40 3630
9. Isacord 40 0232
10. Isacord 40 0640



Be790221  90 x 96 mm
3.5 x 3.8 inch  7.297

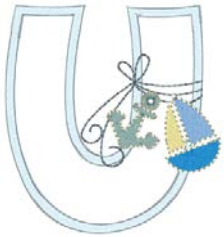

1. Applique 1
2. Applique 2
3. Isacord 40 3963
4. Isacord 40 3852
5. Isacord 40 4752
6. Isacord 40 3900
7. Isacord 40 3630
8. Isacord 40 0232
9. Isacord 40 0660



Be790222  93 x 96 mm
3.7 x 3.8 inch  7.259

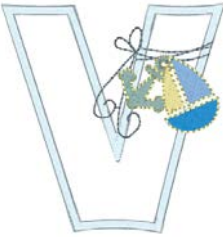

1. Applique 1
2. Applique 2
3. Isacord 40 3963
4. Isacord 40 3852
5. Isacord 40 4752
6. Isacord 40 3900
7. Isacord 40 3630
8. Isacord 40 0232
9. Isacord 40 0630



Be790223  115 x 95 mm
4.5 x 3.8 inch  7.640



1. Applique 1
2. Applique 2
3. Isacord 40 3963
4. Isacord 40 3852
5. Isacord 40 3900
6. Isacord 40 0221
7. Isacord 40 3900
8. Isacord 40 3630
9. Isacord 40 0232
10. Isacord 40 0640



Be790224  93 x 95 mm
3.7 x 3.8 inch  7.340

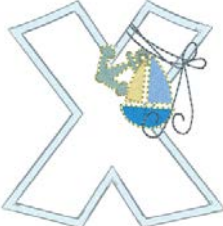

1. Applique 1
2. Applique 2
3. Isacord 40 3963
4. Isacord 40 4752
5. Isacord 40 3900
6. Isacord 40 3630
7. Isacord 40 0232
8. Isacord 40 0630
9. Isacord 40 3852



Be790225  89 x 95 mm
3.5 x 3.8 inch  5.793

1. Applique 1
2. Applique 2
3. Isacord 40 3963
4. Isacord 40 3852
5. Isacord 40 4752
6. Isacord 40 3900
7. Isacord 40 3630
8. Isacord 40 0232
9. Isacord 40 0660



Be790226  59 x 96 mm
2.3 x 3.8 inch  6.774

1. Applique 1
2. Applique 2
3. Isacord 40 3963
4. Isacord 40 3852
5. Isacord 40 3900
6. Isacord 40 0221
7. Isacord 40 3900
8. Isacord 40 3630
9. Isacord 40 0232
10. Isacord 40 0640

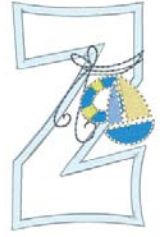

Index

A

Activate/Deactivate Functions.....	23
Activating the Audio Signals	54
Adjust Values.....	24
Altering the Embroidery Design Size Disproportionally.....	62
Altering the Embroidery Design Size Proportionally	62
Altering the Stitch Density.....	63
Attaching the Hoop	47
Attaching the Module.....	43
Attaching the stitch plate.....	37

C

Calibrating the Display	55
Calibrating the Embroidery Hoop	50
Calling up the Embroidery Consultant.....	58
Calling Up the Help.....	58
Calling up the Tutorial	58
Checking the firmware version.....	84
Child safety lock	58
Cleaning the Hook.....	85
Combination Mode.....	70
Combining Embroidery Designs	70
Connecting the foot control.....	31
Creating Lettering.....	73

D

Dispose of the Machine	96
------------------------------	----

E

Editing the Lettering	73
Embroidery file format	27
Embroidery Test.....	28
Energy-saving Mode	58
Entering dealer data.....	56
Environmental Protection.....	9
Error Messages	89
Explanation of Symbols.....	10

F

Firmware	
Activate/Deactivate Functions.....	23
Adjust Values	24
Navigation	23
Fitting the Embroidery Needle.....	35
Free Point Positioning.....	69

I

Inserting the Spool Cap	34
-------------------------------	----

L

Lubricating the Hook	86
----------------------------	----

M

Maintenance and Cleaning	85
--------------------------------	----

N

Navigation	23
Needle, Thread, Fabric	25
Needle/Thread Combination	26
Needles Overview	25

O

Overview Embroidery Module	21
Overview of Embroidery Designs	98

P

Positioning of Grid Points.....	68
Power Cable	31
USA/Canada	31

R

Raising/Lowering the needle	33
Recovering data.....	84
Regulating the Speed.....	59
Removing thread remnants under the stitch plate	85
Restoring the Default Settings.....	55

S

Safety Instructions	7
Saving the service data	57
Select Personal Settings	53
Selecting an Embroidery Design	44
Selecting the language	54
Setting the Display Brightness	54
Setting the Lower Thread Indicator	53
Setting the Sewing Light.....	55
Setting the Upper Thread Indicator	53
Storing the Machine	96
Switching on the Sewing Light.....	32

T

Technical specifications.....	97
-------------------------------	----

Threading the Bobbin Thread.....	41
Threading the Upper Thread	37
Troubleshooting.....	93

U

Updating firmware.....	84
Using eco Mode.....	58
Using the Spool Net.....	34

V

Virtual positioning of the Embroidery Hoop.....	49
---	----



BERNINA recommends threads from *Mettler*[®]

BERNINA International AG | CH-8266 Steckborn Switzerland | www.bernina.com | © Copyright by BERNINA International AG

made to create **BERNINA**

0371485.20A.04
2023-01 EN